



Instruction Manual Digital Sensor Monitor PSE30#A / PSE31#A series



The intended use of the digital sensor monitor is to monitor and display pressure information from a pressure sensor.

1 Safety Instructions

These safety instructions are intended to prevent hazardous situations and/or equipment damage. These instructions indicate the level of potential hazard with the labels of "Caution," "Warning" or "Danger." They are all important notes for safety and must be followed in addition to International Standards (ISO/IEC)⁽¹⁾, and other safety regulations.

⁽¹⁾ ISO 4414: Pneumatic fluid power - General rules relating to systems.
ISO 4413: Hydraulic fluid power - General rules relating to systems.
IEC 60204-1: Safety of machinery - Electrical equipment of machines. (Part 1: General requirements)
ISO 10218-1: Manipulating industrial robots - Safety, etc.

- Refer to product catalogue, Operation Manual and Handling Precautions for SMC Products for additional information.
- Keep this manual in a safe place for future reference.

	Caution	Caution indicates a hazard with a low level of risk which, if not avoided, could result in minor or moderate injury.
	Warning	Warning indicates a hazard with a medium level of risk which, if not avoided, could result in death or serious injury.
	Danger	Danger indicates a hazard with a high level of risk which, if not avoided, will result in death or serious injury.

Warning

- Always ensure compliance with relevant safety laws and standards.**
- All work must be carried out in a safe manner by a qualified person in compliance with applicable national regulations.
- This product is class A equipment intended for use in an industrial environment. There may be potential difficulties in ensuring electromagnetic compatibility in other environments due to conducted or radiated disturbances.
- Refer to the operation manual on the SMC website (URL: <https://www.smcworld.com>) for more safety instructions.

Warning

Special products (-X) might have specifications different from those shown in the specifications section. Contact SMC for specific drawings.

2 Specifications

2.1 General specifications

Product No.		PSE3##A series	
Pressure	Rated pressure range	Refer to table for applicable pressure sensor specification	
	Display / set pressure range		
	Display / minimum setting unit		
Electrical	Power supply voltage	12 to 24 VDC \pm 10%, ripple maximum 10% (p-p)	
	Current consumption	35 mA or less	
	Protection	Polarity protection	
Accuracy	Display accuracy	\pm 0.5% F.S. \pm 1 digit (at ambient temperature 25 °C constant)	
	Repeatability	\pm 0.1% F.S. \pm 1 digit	
	Analogue output accuracy (to displayed value)	\pm 0.5% F.S.	
	Analogue output linearity	\pm 0.2% F.S.	
	Temperature characteristics	\pm 0.5%F.S. (25 °C standard)	
Switch output	Output type	Select from NPN or PNP open collector 2 outputs.	
	Output mode	Select from hysteresis mode, window comparator mode, error output or switch output OFF.	
	Switch operation	Select from normal output or reversed output.	
	Maximum load current	80 mA	
	Maximum voltage (NPN output)	30 VDC	
	Internal volt drop (Residual voltage)	NPN: 1 V or less (Load current 80 mA) PNP: 1.5 V or less (Load current 80 mA)	
	Delay time	1.5 ms or less (delay time available for anti-chatter function: 20, 100, 500, 1000, 2000, 5000 ms)	
	Hysteresis	Hysteresis mode	Variable from 0
		Window comparator mode	
		Protection	
Analogue output	Voltage output	Output type ⁺³	Voltage output: 1 to 5 V, Extended analogue output range: 0.6 to 1 V
		Output impedance	Approx. 1 k Ω
	Current output	Output type ⁺³	Current output: 4 to 20 mA, Extended analogue output range: 2.4 to 4 mA
		Load impedance	Max. load impedance: 300 Ω (at power supply voltage of 12 VDC) 600 Ω (at power supply voltage of 24 VDC) Min. load impedance: 50 Ω
Auto-shift	Response time	50 mA or less	
	Input type	Non-voltage input: 0.4 V or less	
	Input mode	Select from auto-shift, auto-shift zero	
Sensor	Input time	5 ms or more	
	Input type	Voltage input: 1 to 5 VDC (Input impedance: 1 M Ω) Current input: 4 to 20 mA (Input impedance: 51 Ω)	
	Number of inputs	1 input	
	Connection method	Connector (e-CON)	
Protection	Over voltage protection (up to 26.4 V)		

2 Specifications (continued)

2.2 Applicable Pressure Sensor specifications

Applicable SMC pressure sensor	Rated pressure range	Display / set pressure range	Display / minimum setting unit
PSE550	0 to 2 kPa	-0.2 to 2.1 kPa	0.001 kPa
PSE531, PSE541, PSE561	0 to -101 kPa	10 to -105 kPa	0.1 kPa
PSE533, PSE543, PSE563, PSE573	-100 to 100 kPa	-105 to 105 kPa	0.1 kPa
PSE532	0 to 100 kPa	-10 to 105 kPa	0.1 kPa
PSE564, PSE574	0 to 500 kPa	-50 to 525 kPa	1 kPa
PSE530, PSE540, PSE560, PSE570	0 to 1 MPa	-0.105 to 1.05 MPa	0.001 MPa
PSE575	0 to 2 MPa	-0.105 to 2.1 MPa	0.001 MPa
PSE576	0 to 5 MPa	-0.25 to 5.25 MPa	0.01 MPa
PSE577	0 to 10 MPa	-0.50 to 10.5 MPa	0.01 MPa

3 Names and function of parts

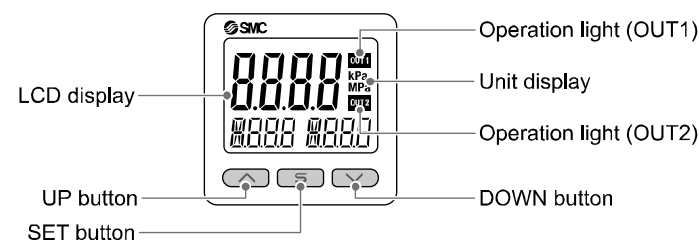

Part	Description
Operation light	Displays the switch operating condition
LCD display	Displays the current status of pressure, setting mode, selected display units and error code. 4 types of display can be selected for the main display: Single constant colour red or green; or switching from red to green or green to red corresponding to the output. The sub display is orange.
UP button	Increases mode and ON/OFF set values
DOWN button	Decreases mode and ON/OFF set values
SET button	Press this button to change mode and to confirm settings
Unit display	Indicates the units currently selected. (Only for display units of kPa and MPa)

4 Installation

4.1 Installation

Warning

- Do not install the product unless the safety instructions have been read and understood.**
- Tighten to the specified tightening torque.**
If the tightening torque is exceeded the mounting screws, brackets and the product can be broken. Insufficient torque can cause displacement of the product from its correct position.
- Do not drop, hit or apply excessive shock to the product.**
Otherwise damage to the internal parts can result, causing malfunction.
- Do not pull the lead wire forcefully, and do not lift the product by pulling the lead wire.**

4 Installation (continued)

4.2 Environment

Warning

- Do not use in an environment where corrosive gases, oil, chemicals, salt water or steam are present.
- Do not use in an explosive atmosphere.
- Do not expose to direct sunlight. Use a suitable protective cover.
- Do not install in a location subject to vibration or impact in excess of the product's specifications.
- Do not mount in a location exposed to radiant heat that would result in temperatures in excess of the product's specifications.

4.3 Mounting with Bracket

- Mount the bracket to the sensor monitor using mounting screws (self-tapping screws: Nominal size 3 x 8L (2 pcs)), then set the product to the specified position.
* Tighten the bracket mounting screws to a torque of 0.5 \pm 0.05 N•m. Self-tapping screws should not be re-used several times.

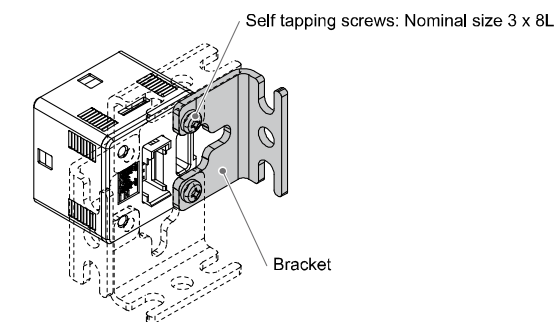

4.4 Mounting with Panel mount adapter

- Mount part (a) to the front of the product and fix it. Then insert the product with (a) into the panel until (a) comes into contact with the panel front surface.
- Next, mount part (b) to the product from the rear and insert it until (b) comes into contact with the panel for fixing.

- Panel mount adapter (Part No.: ZS-46-B)
- Panel mount adapter + Front protective cover (Part No.: ZS-46-D)

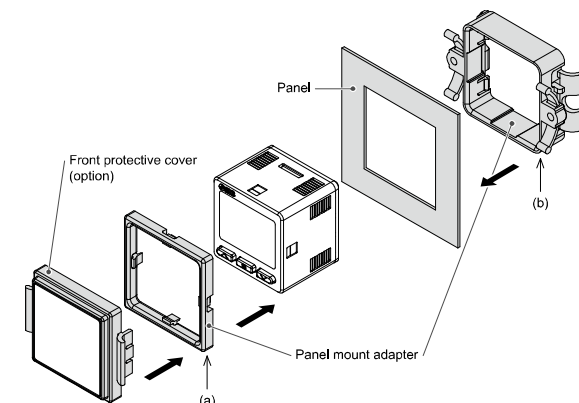

4.5 Removing the Sensor monitor

- When removing the sensor monitor with panel mount adapter from the installation, pull it forward while expanding the hooks on each side as shown below.
If the panel mount adapter is pulled forward with the hook caught, the product and the adapter may be damaged.

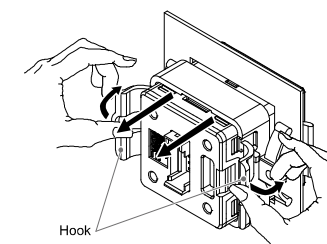

5 Wiring

5.1 Wiring Connection

- Connections should be made with the power supply turned OFF.
- Do not insert or remove the sensor connector with the power ON.
- Use a separate route for the product wiring and any power or high voltage wiring. Otherwise, malfunction may result due to noise.
- If a commercially available switching power supply is used, be sure to ground the frame ground (FG) terminal. If the switching power supply is connected for use, switching noise will be superimposed and it will not be able to meet the product specifications. In that case, insert a noise filter such as a line noise filter/ferrite between the switching power supplies or change the switching power supply to the series power supply.
- When connecting the connector, insert it straight onto the pins and lock the connector into the groove in the housing until the connector clicks.
- When removing the connector, press down the lever to disengage the hook and pull the connector straight out.

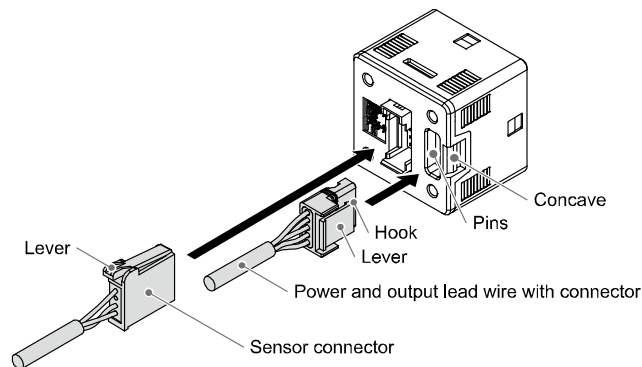

5.2 Power and Output Connector pin layout

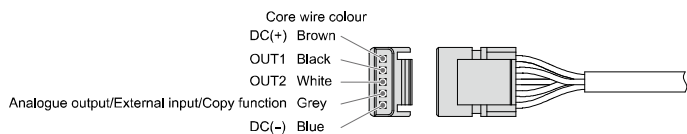

5.3 Sensor Connector wiring

- Attach the connector to the lead wire. The sensor wire should be stripped as shown in the figure.
- Do not cut the insulator.
- Refer to the table below for corresponding connector and wire gauge.

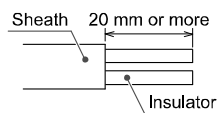

AWG No.	Conductor size (mm ²)	Outer diameter (mm)	Colour	SMC product No. (1 pc.)
26-24 (28)	0.14-0.2 (0.08)	φ0.8 to φ1.0	Red	ZS-28-C
		φ1.0 to φ1.2	Yellow	ZS-28-C-1
		φ1.2 to φ1.6	Orange	ZS-28-C-2
22-20	0.3-0.5	φ1.0 to φ1.2	Green	ZS-28-C-3
		φ1.2 to φ1.6	Blue	ZS-28-C-4
		φ1.6 to φ2.0	Grey	ZS-28-C-5

5.4 Sensor Connector Pin Layout

Connector Pin No.	Wire colour and function		
	PSE30#A (Voltage input)	PSE31#A (Current input)	
		Pressure sensor 2-wire type	Pressure sensor 3-wire type
1	Brown (DC(+))	Brown (LINE(+))	Brown (DC(+))
2	N.C.	N.C.	N.C.
3	Blue (DC(-))	N.C.	Blue (DC(-))
4	Black (OUT: 1 to 5 V)	Blue (LINE(-))	Black (OUT: 4 to 20 mA)

5 Wiring (continued)



- Check that the above-mentioned wire preparation has been performed correctly, then part A shown in the figure is pushed in by hand to make temporary connection.
- Part A centre should be pressed straight in using a suitable tool, such as pliers. The e-CON connector cannot be re-used once it has been completely crimped.
- In case of connection failure or when a pin is mis-wired, please use a new e-CON connector.
- When the sensor is not connected correctly, [LLL] will be displayed.
- The wire colours are applicable for an SMC sensor lead wire.

6 Outline of Settings

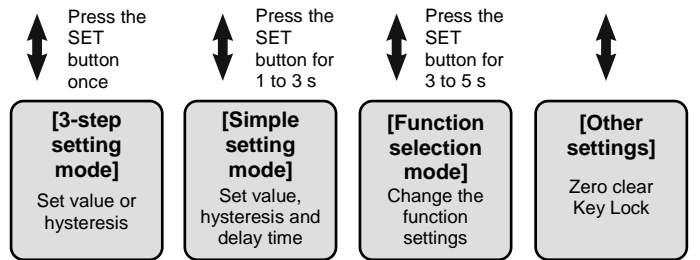
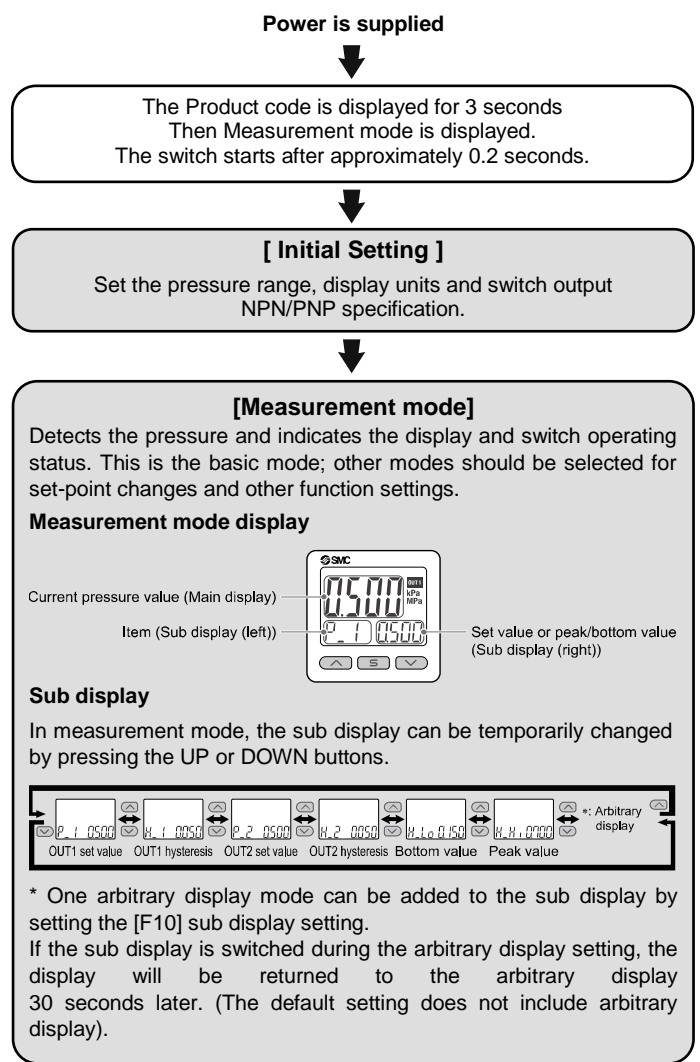

- The outputs will continue to operate during setting.
- If a button is not pressed for a certain time during the setting, the display will flash.
- 3-step setting mode, simple setting mode and function selection mode settings reflect on each other.

7 Settings

7.1 Pressure setting

When the pressure exceeds the set value, the switch will be turned ON. When the pressure falls below the set value by the amount of hysteresis or more, the switch will be turned OFF. The default setting is to turn ON the output at -50.5 kPa when the pressure range of the connected sensor is vacuum. Perform initial setting while referring to the setting outline.

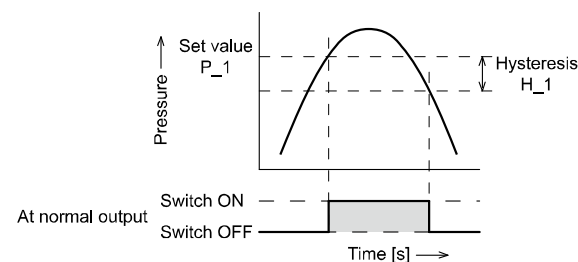

8 3-Step Setting mode

8.1 3-Step setting mode (hysteresis mode)

In 3-step setting mode, the set value (P_1 or n_1, P_2 or n_2) and

hysteresis (H_1, H_2) can be changed. Set the items on the sub display (set value or hysteresis) using the DOWN button. When changing the set value, follow the operation below. The hysteresis setting can be changed in the same way.

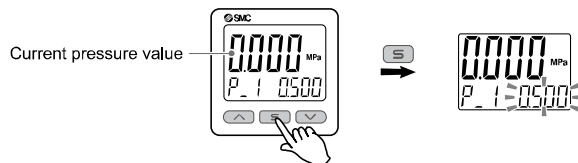

- Press the SET button once when the item to be changed is shown on the sub display. The set value on the sub display (right) will start flashing.
- Press the UP or DOWN button to change the set value. When the UP and DOWN buttons are pressed and held simultaneously for 1 second or longer, the set value is displayed as [- - -], and the set value will be the same as the current pressure value automatically (snap shot function). Afterwards, it is possible to adjust the value by pressing the UP or DOWN button.
- Press the SET button to complete the setting.

The product will turn on within a set pressure range (OUT1: from P1L to P1H, OUT2: from P2L to P2H) during window comparator mode. Set P1L/P2L, the lower limit of the switch operation, and P1H/P2H, the upper limit of the switch operation and WH1/WH2 (hysteresis). When reversed output is selected, the sub display (left) will show [n1L] / [n2L] and [n1H] / [n2H].

- Setting of the normal/reverse output switching and hysteresis/window comparator mode switching are performed with the function selection mode [F 1] Setting of OUT1, [F 2] Setting of OUT2.

9 Simple Setting mode

- Press and hold the SET button for between 1 and 3 seconds in measurement mode. [SET] is displayed on the main display. When the button is released while in the [SET] display, the current pressure value is displayed on the main display, [P_1] or [n_1] is displayed on the sub display (left), and the set value is displayed on the sub display (right) (Flashing).

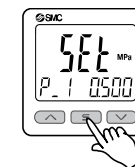

- Change the set value with the UP or DOWN buttons, and press the SET button to set the value. Then, the setting moves to hysteresis setting (The snap shot function can also be used).
- Change the hysteresis value using the UP or DOWN buttons, and press the SET button to set the value. Then, the setting moves to the delay time of the switch output (The snap shot function can also be used).
- The delay time of the switch output can be set by pressing the UP or DOWN button. Delay time setting can prevent the output from chattering.
- Press the SET button for 2 seconds or less to complete the OUT1 setting. [P_2] or [n_2] is displayed on the sub screen (left). Continue with the setting of OUT2. Press and hold the SET button for 2 seconds or longer to complete the setting. The product will return to measurement mode.

- In window comparator mode, set P1L/P2L, the lower limit of the switch operation, and P1H/P2H, the upper limit of the switch operation, WH1/WH2 (hysteresis) and dt1/dt2 (delay time). (When reversed output is selected, the sub display (left) will show [n1L] / [n2L] and [n1H] / [n2H]).

10 Function Selection mode

In measurement mode, press the SET button for between 3 and 5 seconds, to display [F 0]. Select to display the function to be changed [F□□]. Press and hold the SET button for 2 seconds or longer to return to measurement mode.

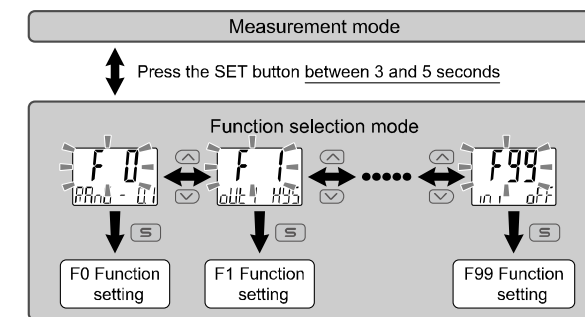

- Some products do not have all the functions. If a function is not available or selected due to configuration of other functions, [- - -] is displayed on the sub display (right).
- Refer to the operation manual on the SMC website (URL: <https://www.smcworld.com>) for more information about the Functions available.

10 Function Selection mode (continued)

10.1 Default function settings

The default settings are shown in the table below.

If there is no problem with this setting, keep these settings.

To change a setting, enter function selection mode

Switching function of [F 0]

The default settings for pressure range, display units and switch output.

Item	Default setting
Connected sensor range	-101 kPa
Display units	kPa
Switch output specifications	NPN / PNP*

*: Depends on part number.

Setting of OUT1 and OUT2

Item	Explanation	Default setting
Output mode	Either hysteresis mode, window comparator mode, error output or switch output OFF can be selected.	Hysteresis mode
Reversed output	Selects which type of switch output is used, normal or reversed.	Normal output
Pressure setting	Sets the ON and OFF point of the switch output.	-50.5 kPa
Hysteresis	Appropriate setting of the hysteresis will prevent the switch output from chattering.	5.1 kPa
Delay time	Delay time of the switch output can be selected.	1.5 ms or less
Display colour	Select the display colour.	Output ON : Green Output OFF: Red (Linked to OUT1)

10.2 Other Parameters

Item	Description	Default
[F 3]	Digital filter setting	0.00 sec.
[F 4]	Auto-preset function	Not used
[F 5]	FUNC terminal setting	Analogue output
[F 6]	Fine adjustment of display value	0.0%
[F10]	Sub display setting	Standard
[F11]	Display resolution setting	1000-split
[F80]	Power saving mode	OFF
[F81]	Security code	OFF
[F82]	Input of line name	AAAA
[F90]	Setting of all functions	OFF
[F96]	Input signal check	N/A
[F97]	Selection of copy check	N/A
[F98]	Output check	N/A
[F99]	Reset to default settings	OFF

11 Other Settings

- Snap shot function
- Peak / Bottom value function
- Zero-clear function
- Key-lock function

Refer to the operation manual on the SMC website (URL: <https://www.smcworld.com>) for setting these functions.

12 Outline Dimensions (mm)



Refer to the operation manual or catalogue on the SMC website (URL: <https://www.smcworld.com>) for the Outline Dimensions.

13 How to Order

Refer to the operation manual or catalogue on the SMC website (URL: <https://www.smcworld.com>) for How to Order information.

14 Troubleshooting

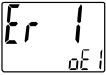
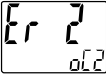
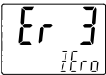
14.1 Error indication

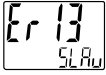
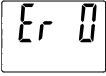
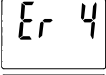
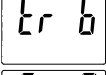
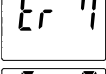
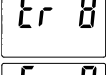
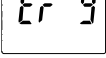
Error	Display	Description	Measures
Over current error	 	The switch output load current is 80 mA or more.	Turn the power off and remove the cause of the over current. Then supply the power again.
Residual pressure error		During zero clear operation, pressure greater than $\pm 7\%$ F.S. ($\pm 3.5\%$ F.S. for compound pressure) is present. Note that the mode is returned to measurement mode automatically 1 sec. later. The zero clear range varies by $\pm 1\%$ F.S. due to variation between individual products.	Release the applied pressure to atmospheric pressure, and retry the zero clear operation.
Pressure error		Pressure exceeding the upper limit of the set pressure range is applied.	Reset applied pressure to a level within the set pressure range. Check the sensor connection and wiring.
		Pressure exceeding the lower limit of the set pressure range is applied. Sensor is not connected or wired incorrectly.	
Copy error		Failed to operate copy function	Press the UP and DOWN buttons for 1 second or longer to recover. Try copy function after checking wiring, product model etc.
System error	     	Displayed if an internal data error has occurred.	Turn the power off and on again. If the failure cannot be solved, contact SMC.

If the error cannot be reset after the above measures are taken, or errors other than above are displayed, please contact SMC.

15 Maintenance

15.1 General Maintenance

Caution

- Not following proper maintenance procedures could cause the product to malfunction and lead to equipment damage.
- If handled improperly, compressed air can be dangerous.
- Maintenance of pneumatic systems should be performed only by qualified personnel.
- Before performing maintenance, turn off the power supply and be sure to cut off the supply pressure. Confirm that the air is released to atmosphere.
- After installation and maintenance, apply operating pressure and power to the equipment and perform appropriate functional and leakage tests to make sure the equipment is installed correctly.
- If any electrical connections are disturbed during maintenance, ensure they are reconnected correctly and safety checks are carried out as required to ensure continued compliance with applicable national regulations.
- Do not make any modification to the product.
- Do not disassemble the product, unless required by installation or maintenance instructions.

How to reset the product after power cut or forcible de-energizing

The setting of the product will be retained as it was before a power cut or de-energizing. The output condition is also basically recovered to that before a power cut or de-energizing, but may change depending on the operating environment.

Therefore, check the safety of the whole installation before operating the product. If the installation is using accurate control, wait until the product has warmed up (approximately 10 to 15 minutes).

16 Limitations of Use

16.1 Limited warranty and Disclaimer/Compliance Requirements

Refer to Handling Precautions for SMC Products.

17 Product disposal

This product shall not be disposed of as municipal waste. Check your local regulations and guidelines to dispose of this product correctly, in order to reduce the impact on human health and the environment.

18 Contacts

Refer to www.smcworld.com or www.smc.eu for your local distributor / importer.

SMC Corporation

URL: <https://www.smcworld.com> (Global) <https://www.smc.eu> (Europe)
SMC Corporation, 4-14-1, Sotokanda, Chiyoda-ku, Tokyo 101-0021, Japan
Specifications are subject to change without prior notice from the manufacturer.
© 2021 SMC Corporation All Rights Reserved.
Template DKP50047-F-085M