

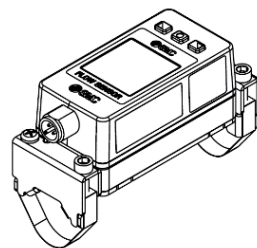

ORIGINAL INSTRUCTIONS

**Instruction Manual**  
**Clamp on type Flow Sensor**  
**PFUW7# series**



The intended use of the ultrasonic flow sensor is to monitor and control flow and provide an output signal.

**1 Safety Instructions**

These safety instructions are intended to prevent hazardous situations and/or equipment damage. These instructions indicate the level of potential hazard with the labels of "Caution," "Warning" or "Danger." They are all important notes for safety and must be followed in addition to International Standards (ISO/IEC)<sup>1)</sup>, and other safety regulations.

- <sup>1)</sup>ISO 4414: Pneumatic fluid power — General rules and safety requirements for systems and their components.
- ISO 4413: Hydraulic fluid power — General rules and safety requirements for systems and their components
- IEC 60204-1: Safety of machinery - Electrical equipment of machines. Part 1: General requirements
- ISO 10218-1: Robots and robotic devices - Safety requirements for industrial robots - Part 1: Robots

- Refer to product catalogue, Operation Manual and Handling Precautions for SMC Products for additional information.
- Keep this manual in a safe place for future reference.

	<b>Danger</b>	Danger indicates a hazard with a high level of risk which, if not avoided, will result in death or serious injury.
	<b>Warning</b>	Warning indicates a hazard with a medium level of risk which, if not avoided, could result in death or serious injury.
	<b>Caution</b>	Caution indicates a hazard with a low level of risk which, if not avoided, could result in minor or moderate injury.

**Warning**

- Always ensure compliance with relevant safety laws and standards.**
- All work must be carried out in a safe manner by a qualified person in compliance with applicable national regulations.
- This product is class A equipment intended for use in an industrial environment. There may be potential difficulties in ensuring electromagnetic compatibility in other environments due to conducted or radiated disturbances.
- Refer to the operation manual on the SMC website (URL: <https://www.smcworld.com>) for more safety instructions.

**2 Specifications**

**2.1 General specifications**

Item	Specifications	
Environmental	Enclosure	IP65/IP67 (IEC 60529)
	Operating temperature	Operating: 0 to 50 °C, Storage: -10 to 60 °C (no freezing or condensation)
	Humidity range	35 to 85% R.H. (no condensation)
	Withstand voltage	250 VAC for 1 min. between terminals and housing
	Insulation resistance	2 MΩ min (with 50 VDC) between terminals and housing
Materials	Detection part: Special rubber Clamp assembly set: SUS304	

**2 Specifications (continued)**

**2.2 PFUW7# specifications**

Model	PFUW760	PFUW711
Piping	Applicable piping material <sup>1)</sup>	
	Metal piping, Hard resin piping	
Port size	A Type	15 A
	B Type	1/2B
Fluid	Applicable fluids <sup>2)</sup>	
	General liquids (Water, Oil, Chemical liquids, etc)	
Fluid temperature range	0 to 90 °C (No freezing or condensation)	
	Detection method	
Ultrasonic (propagation time difference method)		
Rated flow range <sup>3)</sup>	0 to 60 L/min (less than 0.6 L/min displayed as 0.0 L/min)	0 to 100 L/min (less than 1.0 L/min displayed as 0.0 L/min)
	Detection method	
Display/setting flow range	Instantaneous flow	-3 to 84 L/min
	Accumulated flow	-5 to 140 L/min
Minimum display/setting units	Instantaneous flow	0 to 999,999,999 L
	Accumulated flow	0.1 L/min
Zero cut range	Instantaneous flow	1 L
	Accumulated flow	0 to ±10% F.S. (selected in 1% F.S. increments relative to the maximum rated flow rate)
Converted integrated pulse value	1 L/pulse (pulse width = 50 ms)	
Accumulated value hold time <sup>4)</sup>	Selectable from 2 min. or 5 min. intervals	
Accuracy <sup>5)</sup>	Display accuracy	±3.0% F.S.
	Analogue output accuracy	±3.0% F.S.
	Repeatability	±2.0% F.S.
Temperature characteristics	±5.0% F.S. (25 °C reference)	
	Output type <sup>7)</sup>	Voltage output: 1 to 5 V or 0 to 10 V, Current output: 4 to 20 mA
Impedance		Voltage output
	Current output	Max. Load impedance: 600 Ω (at 24 VDC)
Response time	Linked with digital filter setting value	
External input <sup>8)</sup>	Input voltage	NPN: 0.4 V or less (with or without contact) PNP: DC(+) -1 V or more
	Input mode	Select from accumulated external value reset, peak/bottom reset, zero-clear
	Input time	30 ms or more
Switch output	Output type	NPN or PNP open collector output
	Output mode	Select from hysteresis or window comparator mode, accumulated flow output, accumulated pulse output, error output and switch output OFF
	Switch operation	Forward or Reverse output
	Max. load current	80 mA
	Max. applied voltage (NPN only)	30 VDC
	Internal voltage drop (Residual voltage)	1.5 V or less (at 80 mA load current)
	Delay time <sup>9)</sup>	5 ms or less, variable from 0 to 60 s / 0.01 s increments
Hysteresis <sup>10)</sup>	Variable from 0	
Protection	Switch output reverse connection, over current protection	

**2 Specifications (continued)**

Model	PFUW760	PFUW711	
Electrical	Power supply voltage	18 to 30 VDC	
	Current consumption	85 mA or less	
	Protection	Power supply polarity protection	
Display	Display mode	Main display: Instantaneous flow rate Sub display: Set flow rate display, Accumulated flow rate display, etc.	
	Units <sup>11)</sup>	Instantaneous flow	L/min, gal/min
		Accumulated flow	L, gal
	LCD Display	Display colour: white / orange / red / green / blue: Rotation 90° / 180° / 270°. Display update cycle 10 times / sec.	
Digital filter <sup>12)</sup>	0.5, 1.0, 2.5, 5, 10, 30, 60 s		
Weight	Detection Unit	Approx. 165 g	
	Clamp assembly set	Approx. 46 g	Approx. 45 g

- <sup>1)</sup> Depending on the type and condition of the pipework, such as the lined or coated pipes, detection may be unstable. Recommended piping materials are as follows.
  - Metal piping: SGP, SUS304 (Sch20/40/80)
  - Hard resin piping: VP, H1VP, H1VVP.
 For other types of piping, adjust via "F11" the measurement value inclination fine adjustment function.
- <sup>2)</sup> The detection may become unstable if the fluid contains a large amount of foreign matter or air bubbles.
- <sup>3)</sup> Fluctuates in conjunction with the zero-cut function setting.
- <sup>4)</sup> When using the accumulated value hold function, calculate the product life from the operating conditions, and use the product within its life. The maximum access limit of the memory device is 1 million cycles. If the product is operated 24 hours per day, the product life will be as follows:
  - Data stored every 2 minutes --- 2 minutes x 1 million times = 2 million minutes = 3.8 years
  - Data stored every 5 minutes --- 5 minutes x 1 million times = 5 million minutes = 9.5 years
 If the accumulated flow external reset is also repeatedly used, the product life will be shorter.
- <sup>5)</sup> The accuracy is the guaranteed value under normal equipment conditions. Errors may occur depending on the operating conditions (piping type, condition, fluid, temperature). The specification is based on stable flow velocity distribution. Pulsations and fluctuations in flow velocity distribution due to equipment factors are not included.
- <sup>6)</sup> This function is available when the model selected includes an analogue output.
- <sup>7)</sup> When selecting 0 to 10 V, refer to the analogue output graph for the allowable load current.
- <sup>8)</sup> Switch output or External input can be selected by pressing the corresponding buttons.
- <sup>9)</sup> The time can be set from when the instantaneous flow rate reaches the set value to when the switch output operates.
- <sup>10)</sup> If the flow rate fluctuates around the set value, chattering will occur unless a value greater than the fluctuation range is set.
- <sup>11)</sup> This is only available for models with the units selection function.
- <sup>12)</sup> The digital filter time can be set for the sensor input. This is 90% of the response time to step input.
- <sup>13)</sup> SMC strive to improve quality, but products with tiny scratches or smears on the appearance, or variation in the display colour or brightness, which does not affect the performance of the product, are verified as conforming products

**2.3 Cable specifications (lead wire ZS-37-A, ZS-49-A)**

Conductor	Nominal cross section	AWG23
Insulator	Outside diameter	Approx. 1.1 mm
	Colours	Brown, White, Black, Blue
Sheath	Material	Oil resistant PVC
	Outer diameter	φ4

**2.4 Characteristics data**

- Flow rate / Analogue Output

	A	B
Voltage output (1 to 5 V)	1 V	5 V
Current output	4 mA	20 mA
	0 L/min	C
Voltage output (0 to 10 V) <sup>1)</sup>	0 V	10 V

**2 Specifications (continued)**

- <sup>1)</sup>: Analogue output accuracy is within ±3% F.S.
- <sup>2)</sup>: Analogue output is not affected by the zero-cut function setting.
- <sup>3)</sup>: The analogue output current from the connected equipment should be 20 μA or less when selecting 0 to 10 V. When 20 μA or more current flows, it is possible that the accuracy is not satisfied at less than or equal to 0.5 V.

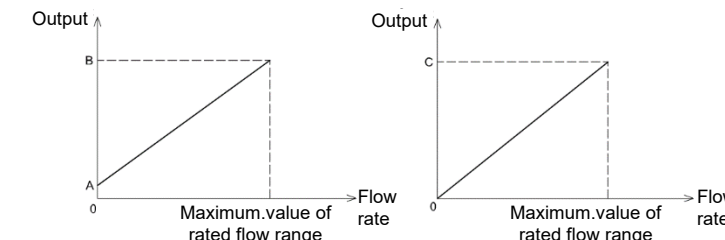

**Warning**

- Special products (-X) might have specifications different from those shown in this section. Contact SMC for specific drawings.

**3 Name and function of parts**

**3.1 PFUW7#**

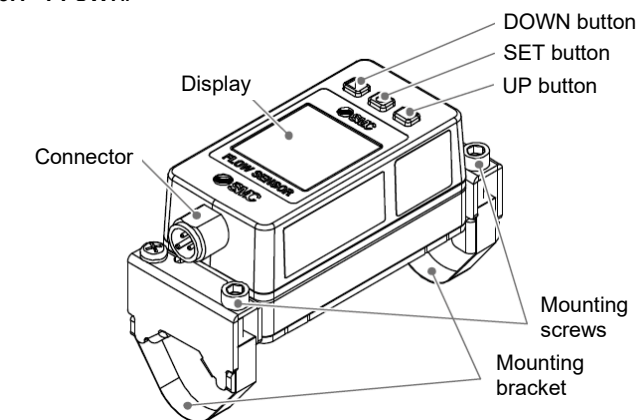

Item	Description
Display	Refer to the details below.
Connector	For Lead wire with M12 connection.
UP button *	Select the mode and the display shown on the Sub display and increases the switch point value.
SET button	Press this button to change the mode and to set a value.
DOWN button *	Select the mode and the display shown on the Sub display and decreases the switch point value.

\*: If the reversed display has been selected, the UP and DOWN button functions will be reversed.

**3.2 Display**

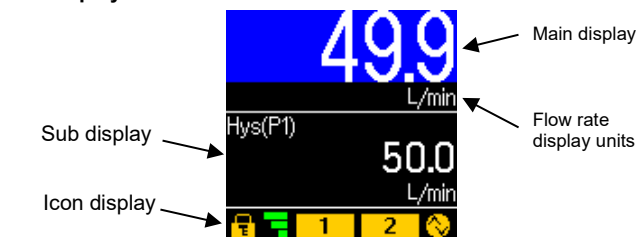

Item	Description
Main display	Displays the flow rate value and the error code.
Sub display	Set value, displays the peak/bottom hold value, accumulated flow rate value, IO-Link communication mode, and line name.
Icon display	Displays the function status. See below.
Flow rate display units	Indicates the units currently selected.

### 3 Name and function of parts (continued)

#### 3.3 Icon display

Icon	Name	Description
	Key-lock	LED is ON when buttons are locked.
	Ultrasonic indicator	This icon represents the ultrasonic detection level (stability).  0 1 2 3 4 • Level 0: Detection is disabled. • Level 1: Low stability • Level 2: Medium stability • Level 3: High stability • Level 4: Excessive ultrasonic detection Ultrasonic detection levels vary depending on the pipe type, the fluid, the condition of the pipework, the product's installation, and whether or not bubbles are present in the fluid. If the ultrasonic detection level is low, check the piping condition and installation. Depending on the piping condition, changing the piping installation position may change the ultrasonic detection level.
	OUT1 status	LED is ON when output1 is ON.
	OUT2 status	LED is ON when output2 is ON.
	IO-Link status	Yellow: Communicating with IO-Link. White: Connecting to IO-Link (including communication disruption). LED is OFF: Not connected to IO-Link.

For further information about the IO-Link communication status indication refer to the operation manual on the SMC website (URL: <https://www.smcworld.com>).

### 4 Installation

#### 4.1 Installation

##### Warning

- Do not install the product unless the safety instructions have been read and understood.
- Use the product within the specified operating rated flow and temperature range.
- Tighten screws to the specified tightening torque. If the tightening torque is exceeded the mounting screws, brackets and the product can be damaged. Insufficient torque can cause displacement of the product from its correct position.
- Do not drop, hit or apply excessive shock to the product.
- Design and install the product so that liquid always fills the detection passage. If the fluid contains air bubbles, check the degree of influence before use.

#### 4.2 Environment

##### Warning

- Do not use in an environment where corrosive gases, chemicals, salt water or steam are present.
- Do not use the product in a place where it is constantly splashed by oil, chemicals or water.
- Do not use in an area where electrical surges are generated.
- Do not use in a place where static electricity is a problem.
- Do not use in the presence of a magnetic field.
- Do not use in an environment that is exposed to temperature cycles.
- Do not expose to direct sunlight. Use a suitable protective cover.
- Do not install in a location subject to vibration or impact in excess of the product specifications.
- Do not mount in a location exposed to radiant heat that would result in temperatures in excess of the product specifications.

### 4 Installation (continued)

#### 4.3 Mounting

- Refer to the flow direction marked on the product before mounting. However, if the product is installed in the opposite direction, it is possible to change the fluid flow direction. Refer to "Setting of [F0 System]."
- Do not mount the product with the display facing downward.
- When mounting the product vertically, fluid must flow from the bottom to the top.
- Never mount the product in a location that will be used as a foothold.
- Install the product on a surface free from seams (trace of welding) or rust. Presence of seams or rust may affect the reliability of detection. On the other hand, avoid installing the product to a location with damage such as dents.
- Do not install multiple products close to each other. Detection signal interference may affect reliability of detection.
- If the display accuracy is acceptable within  $\pm 5\%$  F.S. a straight tube section is not necessary.
- Mount the product using the mounting brackets supplied.
- The recommended tightening torque of screws must be  $76 \text{ cN}\cdot\text{m} \pm 5 \text{ cN}\cdot\text{m}$ .

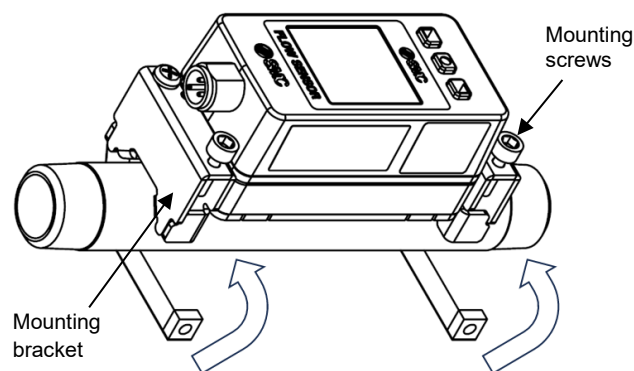

### 5 Wiring

#### 5.1 Wiring

##### Caution

- Wiring should only be performed with the power supply turned OFF.
- Confirm proper insulation of wiring.
- Avoid repeatedly bending, stretching or applying a heavy object to the lead wire.
- Use separate routes for the product wiring and any power or high voltage wiring. Otherwise, malfunction may result due to noise.
- Keep wiring as short as possible to prevent interference from electromagnetic noise and surge voltage.
- If a commercially available switching power supply is used, be sure to ground the frame ground (FG) terminal. If a commercially available switch-mode power supply is connected for use, switching noise will be superimposed and it will not be able to meet the product specifications. In that case, insert a noise filter such as a line noise filter/ferrite between the switching power supplies or change the switching power supply to a series power supply.

#### 5.2 Connecting / disconnecting the connector

- Align the key of the lead wire connector with the key groove on the product connector, and insert the connector straight in. Turn the knurled part clockwise. Connection is complete when the knurled part is fully tightened. Check that the connection is not loose.
- To disconnect the connector, loosen the knurled part and pull the connector straight out.

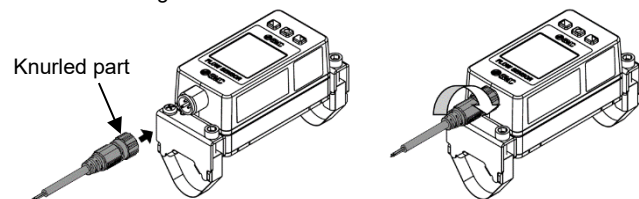

### 5 Wiring (continued)

#### 5.3 Connector pin numbers (on lead wire ZS-37-A, ZS-49-A)

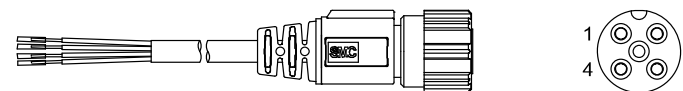

- When used as a switch output device

Pin number	Wire colour	Name	Description
1	Brown	DC(+)	18 to 30 VDC
2	White	OUT2	Not connected / Switch output / Analogue output / External input
3	Blue	DC(-)	0 VDC
4	Black	OUT1	Switch output

- When used as an IO-Link device

Pin number	Wire colour	Name	Description
1	Brown	DC(+)	18 to 30 VDC
2	White	OUT2	Not connected / Switch output / Analogue output / External input
3	Blue	DC(-)	0 VDC
4	Black	C/Q	Communication data (IO-Link) / Switch output (SIO)

### 7 Flow setting

#### Switch operation

When the flow exceeds the set value, the switch will turn ON. When the flow falls below the set value by the amount of hysteresis or more, the switch will turn OFF. The default setting is to turn on the flow switch when the flow reaches the centre of the rated flow range. If this condition shown below, is acceptable, then keep these settings.

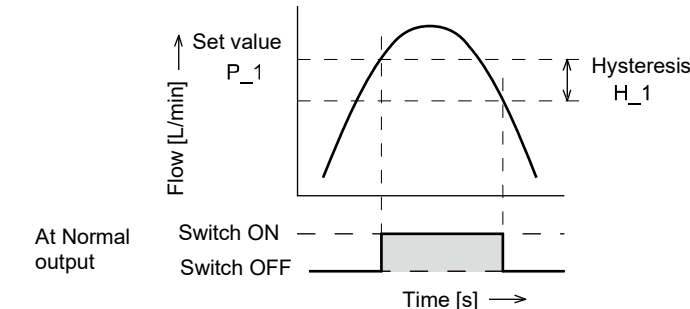

- PFUW760

Item	Default Settings
[P_1] Set value of OUT1	30.0 L/min
[H_1] Hysteresis of OUT1	3.0 L/min
[P_2] Set value of OUT2*	30.0 L/min
[H_2] Hysteresis of OUT2*	3.0 L/min

- PFUW711

Item	Default Settings
[P_1] Set value of OUT1	50.0 L/min
[H_1] Hysteresis of OUT1	5.0 L/min
[P_2] Set value of OUT2*	50.0 L/min
[H_2] Hysteresis of OUT2*	5.0 L/min

\*: OUT2 indicates the value when a product with L2 output specification is used.

### 6 Outline of Settings

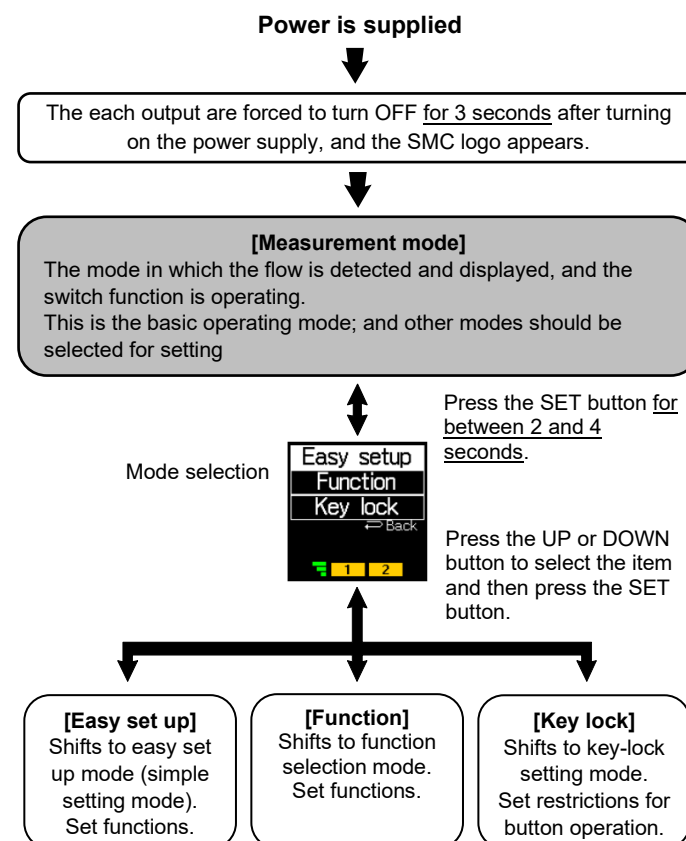

Refer to the operation manual on the SMC website (URL: <https://www.smcworld.com>) for further setting details.

### 8 3-step setting mode

- In this mode, the set values can be input in just three steps. Use this mode if the product is to be used immediately, after changing only the set values. (The current flow rate value is displayed on the main display).

<Operation>  
"3-step setting mode (hysteresis mode)"  
In the 3-step setting mode, the set value (P1 or N1, P2 or N2) and hysteresis (H1 or H2) can be changed. Set the items to be changed on the sub display (set value or hysteresis) in advance using the UP and DOWN buttons. To change the set value, follow the operation below. The hysteresis setting can be changed in the same way.

- Press the SET button once when the item to be changed is displayed on the sub display. The background of the set value turns white.

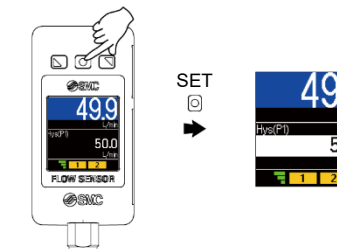

**8 3-step setting mode (continued)**

- (2) Press the UP or DOWN button to change the set value.  
The UP button is used to increase the set value and the DOWN button is used to decrease the set value.
- Press the UP button once to increase by one digit, or press and hold to continuously increase the value.

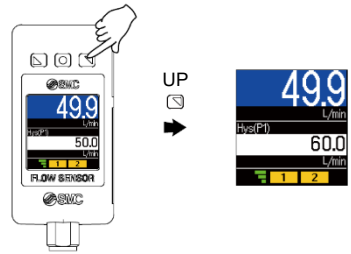

- Press the DOWN button once to decrease by one digit, or press and hold to continuously decrease the value.

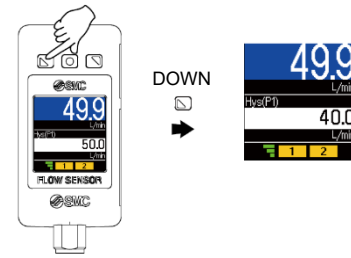

- Press and hold the UP and DOWN buttons simultaneously for 1 second or longer, [Snap shot] will be displayed and the setting will automatically set the same value as the current flow rate value (Snap Shot function).
- After this operation, it is possible to adjust the value by pressing the UP and DOWN buttons.

(3) Press the SET button to complete the setting.

**9 Simple Setting mode [Easy set up]**

In the Simple Setting Mode, it is possible to change the settings for the output set value and hysteresis of the currently selected SW output operation mode.

<Operation>

- (1) Press the SET button for between 2 and 4 seconds in measurement mode. The mode selection screen will be displayed.

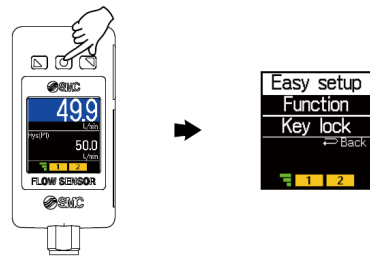

- (2) Select [Easy setup] and press the SET button.  
The screen for changing the set values and hysteresis is displayed.  
\*: For models with L2 output specification, [Hys(P2)] or [Hys(H2)] will be displayed.



**9 Simple Setting mode [Easy set up] (continued)**

- (3) Select [Hys(P1)] and press the SET button.  
To set the hysteresis select [Hys(H1)]. The indication in the brackets changes depending on the setting conditions.

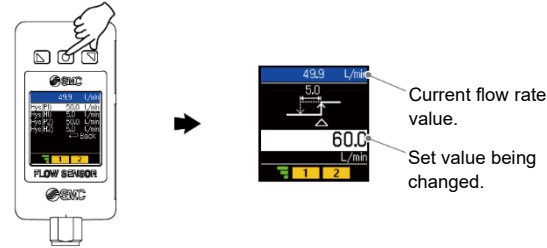

- (4) Press the UP or DOWN button to change the set value.  
The UP button is used to increase the set value and the DOWN button is used to decrease the set value (The snap shot function can also be used).  
Press the SET button to complete the setting.

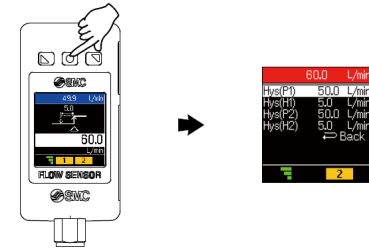

- (5) Select [Back] and press the SET button to return to measurement mode.  
Or it is also possible to press and hold the SET button for 2 seconds or longer to return to measurement mode.
- For models with L2 output specification, [P\_2] or [n\_2] will be displayed. Set these at the same time. (This will not be displayed when OUT2 is used as an external input function [External in]).
  - For any of the items (1) to (4), after enabling the setting by pressing the SET button, it is possible to press and hold the SET button for 2 seconds or longer to enter measurement mode.
  - In window comparator mode and accumulated output mode, it is also possible to configure the settings in the same manner as above. (The simple setting items are not displayed when the accumulated pulse output mode, error output mode, or switch output OFF mode is used).
  - Note that the set value will apply a limit to the value entered for hysteresis, and vice versa.

**10 Function selection mode**

- In this mode, each function setting can be changed separately.
- In measurement mode, press the SET button for between 2 and 4 seconds, then select [Function] to enter function selection mode.
- Press the UP or DOWN button to change the number, each function that you want to change can be selected.

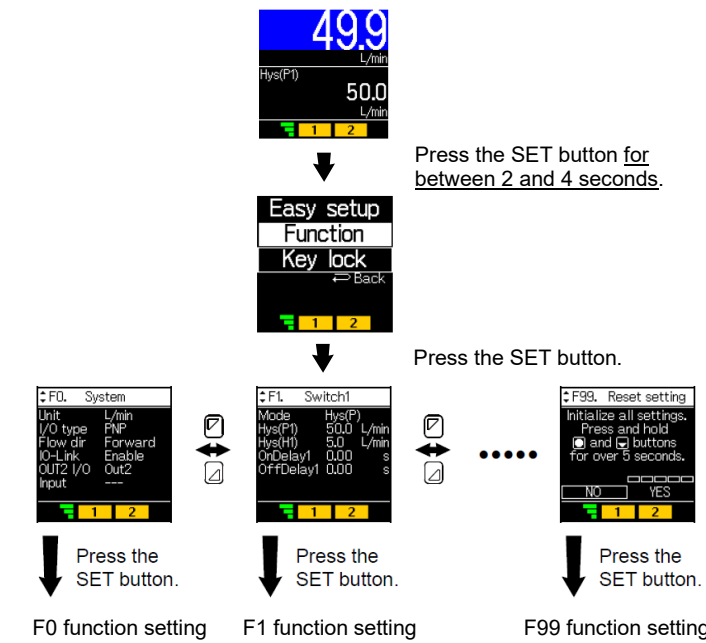

- When setting [F\*] is completed:**  
Press the UP or DOWN button to select [Back], to return to function selection mode.  
Press the SET button for at least 2 seconds to return to measurement mode.
- \*: Some functions are not supported on some models.  
When functions are not available or cannot be selected, [- -] will be displayed or nothing will be displayed.

**10.1 Default settings**

No	Function	Item	Default setting
[F0]	System settings	[Unit] Flow rate display unit	[L/min] L/min(L)
		[I/O TYPE] NPN / PNP	[PNP] PNP output
		[Flow dir] Fluid flow direction	[Forward] Forward direction
		[IO-Link] IO-Link enable / disable	[Enable] Enable
		[OUT2 I/O] SW2 input / output selection *2	[Out2] Out2 output
		[Input] SW2 external input *2	[---] External input not set
[F1]	Switch1 settings (OUT1)	[Mode] Output mode selection	[Hys(P)] Hysteresis mode
		[Hys(P1)] Set value	[ ] 50% max. rated flow PFUW760: 30.0 L/min PFUW711: 50.0 L/min
		[Hys(H1)] Hysteresis	[ ] 5% max. rated flow PFUW760: 3.0 L/min PFUW711: 5.0 L/min
		[OnDelay1] ON delay time	[0.00 s] 0 second
		[OffDelay1] OFF delay time	[0.00 s] 0 second
[F2]	Switch2 settings (OUT2) *2	[Mode] Output mode selection	[Hys(P)] Hysteresis mode
		[Hys(P2)] Set value	[ ] 50% max. rated flow PFUW760: 30.0 L/min PFUW711: 50.0 L/min
		[Hys(H2)] Hysteresis	[ ] 5% max. rated flow PFUW760: 3.0 L/min PFUW711: 5.0 L/min
		[OnDelay2] ON delay time	[0.00 s] 0 second
		[OffDelay2] OFF delay time	[0.00 s] 0 second
[F10]	Measurement settings	[Filter] Digital filter	[1.0] 1.0 s
		[Zero cut] Zero cut	[1] 1% F.S. cut
		[Resolution] Display resolution	[High] PFUW760: 600 resolution PFUW711: 1000 resolution

**10 Function selection mode (continued)**

No	Function	Item	Default setting
[F11]	Ultrasonic measurement settings	[Power] Ultrasonic transmission power	[High] Transmission power: High
		[Schedule] Piping schedule	[SGP] SGP piping
		[Span adj] Measurement value inclination fine adjustment	[0.0] Inclination adjustment rate: 0.0%
[F22]	Analogue output settings	[Type] Analogue output switch *3	[1 to 5 V] 1 to 5 V Voltage output type. [4 to 20 mA] 4 to 20 mA Current output type. *: The current output type cannot be changed.
		[Free span] Analogue free range *3	[ ] 100% max. rated flow PFUW760: 60.0 L/min PFUW711: 100.0 L/min
[F30]	Accumulated flow (rate) settings	[Save intvl] Accumulation storage interval	[No save] Not to hold
		[Disp mode] Accumulated display direction	[Increment] Addition direction
[F50]	Instantaneous SW bit 1 setting	[Mode] Output mode selection	[Hys(P)] Hysteresis mode
		[Hys(P1)] Set value	[ ] 50% max. rated flow PFUW760: 30.0 L/min PFUW711: 50.0 L/min
		[Hys(H1)] Hysteresis	[ ] 5% max. rated flow PFUW760: 3.0 L/min PFUW711: 5.0 L/min
		[OnDelay1] ON delay time	[0.00] 0.00 s
		[OffDelay1] OFF delay time	[0.00] 0.00 s
[F51]	Instantaneous SW bit 2 setting *2	[Mode] Output mode selection	[Hys(P)] Hysteresis mode
		[Hys(P2)] Set value	[ ] 50% max. rated flow PFUW760: 30.0 L/min PFUW711: 50.0 L/min
		[Hys(H2)] Hysteresis	[ ] 5% max. rated flow PFUW760: 3.0 L/min PFUW711: 5.0 L/min
		[OnDelay2] ON delay time	[0.00] 0.00 s
		[OffDelay2] OFF delay time	[0.00] 0.00 s
[F52]	Accumulation SW 1/2 bit setting	[Sw1] Set value	[0] 0 L
		[Sw2] Set value	[0] 0 L
[F80]	Display settings	[Colour] Measurement value display colour	[1onB.offR] OUT1 output ON = white characters on blue background, OFF = white characters on red background.
		[Display] Display OFF	[ON] Display ON
		[Rotation] Display rotation angle	[0deg] Rotation angle 0°
		[Brightness] Display brightness	[100%] Brightness 100%
		[Line name] Line name	[OFF] No line name
[F81]	PIN code settings	[PIN code] PIN code	[OFF] Not used
[F91]	Device information	-	Information check (No settings)
[F96]	Input check	-	Input check (No settings)
[F98]	Output check	-	[Normal] Normal output
[F99]	Reset to factory default settings	-	[NO] Not to be reset

\*1: The display units setting is only available for models with the units selection function.

\*2: The [F2] setting is only available for models with L2 output specification.

\*3: The [F22] function is only available for models with analogue output.

## 11 IO-Link parameter settings

### 11.1 IODD file

IODD (I/O Device Description) is a definition file which provides all properties and parameters required for establishing functions and communication of the device.

- The IODD includes the main IODD file and a set of image files such as vendor logo, device picture and device icon.
- The IODD file for this product is as follows:

Product number	IODD file *
PFUW7**-**-**	SMC-PFUW7**-**-**-yyyymmdd-IODD1.1

- \*: "\*" indicates the product model which corresponds to each IODD file.
- \*: "yyyymmdd" indicates the date of creation of the file, with yyyy, mm, and dd representing the year, month, and date, respectively.

- The IODD file can be downloaded from the SMC website (URL: <https://www.smcworld.com>).

### 11.2 IO-Link specifications

IO-Link type	Device
IO-Link version	V1.1
Communication speed	COM2 (38.4 kbps)
Min. cycle time	4.5 ms
Process data length	Input Data: 8 bytes, Output Data: 0 bytes
On request data communication	Available
Data storage function	Available
Event function	Available

## 12 Other Settings

- Snap shot function
- Reset function
- Zero clear function

For further details refer to the operation manual on the SMC website (URL: <https://www.smcworld.com>).

## 13 How to Order



Refer to the operation manual or catalogue on the SMC website (URL: <https://www.smcworld.com>) for How to order information.

## 14 Outline Dimensions (mm)



Refer to the operation manual or catalogue on the SMC website (URL: <https://www.smcworld.com>) for Outline Dimensions.

## 15 Troubleshooting

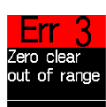
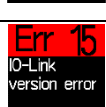
### 15.1 Error display

Error name	Error display	Description	Measures	Control operation during an error
System error (Err0,4,6,7,8,10,40,82,83)		An internal data error has occurred.	Turn off the power and check for any noise source, and then turn on the power again. If the failure cannot be solved, contact SMC.	Stop
OUT1 Over current error (Err1)		The switch output load current has exceeded 80 mA.	Remove the cause of the excessive current in the output.	Continues
OUT2 Over current error (Err2)		The switch output load current has exceeded 80 mA.	Remove the cause of the excessive current in the output.	Continues
Zero clear error (Err 3)		During a zero clear operation, a flow rate exceeding $\pm 10\%$ F.S. is applied.	Perform the zero-clear operation again when the flow rate is not applied.	Continues
Version does not match (Err 15)		The IO-Link version does not match with the master.	Align the master IO-Link version to the device.	Continues

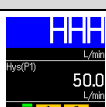
### 15.2 Warning display

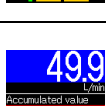
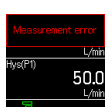
Warning name	Warning display	Description	Measures	Control operation during the warning
Outside instantaneous flow measurement (HHH) (LLL)		Flow rate exceeding the upper limit of the display flow range applied.	Reduce the flow.	Continues
		Flow rate below the lower limit of the display flow range applied.	Apply flow in the correct direction. Set the correct flow rate direction using the [F0_Flow dir] function.	Continues
Accumulated flow warning (Reached accum max) (Reached accum low)		Accumulated value exceeded the accumulated flow range (for accumulated increment).	Reset the accumulated flow. (Press and hold the SET and DOWN buttons simultaneously for <u>1 second or longer</u> ).	Continues
		Accumulated value reached the set accumulated value (for accumulated decrement).		Continues
Measurement cannot be made (Measurement error)		Measurement impossible due to sensor / piping / fluid factors.	Check the tightness of the mounting fittings, the presence of air bubbles, whether the flow channel is full of fluid and whether the rubber sheet is broken.	Continues

Refer to the operation manual or catalogue on the SMC website (URL: <https://www.smcworld.com>) for Troubleshooting details.

## 16 Maintenance

### 16.1 General Maintenance

#### Caution

- Not following proper maintenance procedures could cause the product to malfunction and lead to equipment damage.
  - If handled improperly, compressed air can be dangerous.
  - Maintenance of pneumatic systems should be performed only by qualified personnel.
  - Before performing maintenance, turn off the power supply and be sure to cut off the supply pressure. Confirm that the air is released to atmosphere.
  - After installation and maintenance, apply operating pressure and power to the equipment and perform appropriate functional and leakage tests to make sure the equipment is installed correctly.
  - If any electrical connections are disturbed during maintenance, ensure they are reconnected correctly and safety checks are carried out as required to ensure continued compliance with applicable national regulations.
  - Do not make any modification to the product.
  - Do not disassemble the product, unless required by installation or maintenance instructions.
- How to reset the product after a power cut or when the power has been unexpectedly removed**  
The settings of the product are retained from before the power cut or de-energizing. The output condition also recovers to that before the power cut or de-energizing, but may change depending on the operating environment. Therefore, check the safety of the whole system before operating the product.

## 17 Limitations of Use

### 17.1 Limited warranty and Disclaimer/Compliance Requirements

Refer to Handling Precautions for SMC Products.

## 18 Product disposal

This product should not be disposed of as municipal waste. Check your local regulations and guidelines to dispose of this product correctly, in order to reduce the impact on human health and the environment.

## 19 Contacts

Refer to [www.smcworld.com](http://www.smcworld.com) or [www.smc.eu](http://www.smc.eu) for your local distributor / importer.

## SMC Corporation

URL : <https://www.smcworld.com> (Global) <https://www.smc.eu> (Europe)  
SMC Corporation, 4-14-1, Sotokanda, Chiyoda-ku, Tokyo 101-0021, Japan  
Specifications are subject to change without prior notice from the manufacturer.  
© SMC Corporation All Rights Reserved.  
Template DKP50047-F-085N