



ORIGINAL INSTRUCTIONS

Instruction Manual

Card Motor

LAT3*-*/ / LATCA-* series



The intended use of the Card Motor is to convert an electrical input signal into mechanical motion.

1 Safety Instructions

These safety instructions are intended to prevent hazardous situations and/or equipment damage. These instructions indicate the level of potential hazard with the labels of "Caution," "Warning" or "Danger."

They are all important notes for safety and must be followed in addition to International Standards (ISO/IEC) ⁽¹⁾, and other safety regulations. ⁽¹⁾ ISO 4414: Pneumatic fluid power - General rules relating to systems.

ISO 4413: Hydraulic fluid power - General rules relating to systems.

IEC 60204-1: Safety of machinery - Electrical equipment of machines. (Part 1: General requirements)

ISO 10218-1: Manipulating industrial robots -Safety. etc.

- Refer to the product catalogue, Operation Manual and Handling Precautions for SMC Products for additional information.
- Keep this manual in a safe place for future reference.

	Caution	Caution indicates a hazard with a low level of risk which, if not avoided, could result in minor or moderate injury.
	Warning	Warning indicates a hazard with a medium level of risk which, if not avoided, could result in death or serious injury.
	Danger	Danger indicates a hazard with a high level of risk which, if not avoided, will result in death or serious injury.

Warning

- Always ensure compliance with relevant safety laws and standards.
- All work must be carried out in a safe manner by a qualified person in compliance with applicable national regulations.
- Electromagnetic compatibility: This product is class A equipment that is intended for use in an industrial environment. There may be potential difficulties in ensuring electromagnetic compatibility in other environments due to conducted as well as radiated disturbances.
- Do not disassemble, modify or repair the product.
- Do not operate the product beyond the specification range.
- Keep the controller and product combined as delivered for use. The product is set in parameters for shipment. If it is combined with a different product parameter, failure can result.
- For further Safety Instructions refer to the operation manual on the SMC website (URL: <https://www.smcworld.com>).

Warning

For special products which include a suffix of "-X#", "-D#", refer to the customer drawing of that specific product.

2 Specifications

2.1 Card Motor (LAT3)

Model	LAT3-10	AT3F-1	LAT3-20	AT3F-2	LAT3-30	AT3F-3	AT3M-5	LAT3F-50	
Stroke [mm]	10		20		30			50	
Motor	Moving magnet type linear motor								
	Type								
	Maximum instantaneous thrust [N] <small>Note 1) Note 2) Note 3)</small>	5.2		6		5.5		2.5	
Guide	Linearguide with circulating balls								
	Maximum work load [g]	Horizontal: 500, Vertical: 100		Horizontal: 500, Vertical: 0		Horizontal: 500, Vertical: -			
Sensor	Optical linear encoder (incremental)								
	Type								
	Resolution [μm]	30	1.25	30	1.25	30	1.25	5	1.25
Pushing operation	Home position signal	None	Provided	None	Provided	None	Provided	Provided	
	Pushing speed [mm/s] <small>Note 1) Note 2) Note 3)</small>	6							
Positioning Operation	Set value of force	1 to 5		1 to 4.8		1 to 3.9		1 to 2	
	Positioning repeatability [μm] <small>Note 4) Note 5)</small>	±90	±5	±90	±5	±90	±5	±20	±5
Measurement	Accuracy [μm] <small>Note 4) Note 5)</small>	±100	±10	±100	±10	±100	±10	±40	±10
Maximum speed [mm/s] <small>Note 6)</small>	400								
Operating temperature range [°C]	5 to 40 (No condensation)								
Operating humidity range [%]	35 to 85 (No condensation)								
Weight [g] <small>Note 7)</small>	130		190		250			360	
Table weight [g]	50		70		90			110	

Note 1) Continuous thrust can be generated and maintained continuously. Instantaneous maximum thrust can be generated.

Note 2) When mounted on a heat dissipating base at an ambient temperature of 20°C.

Note 3) The pushing force varies depending on the operating environment, pushing direction and table position.

Note 4) When the temperature of the Card Motor is 20°C.

Note 5) The accuracy after mounting the Card Motor may vary depending on the mounting conditions, operating conditions and environment, so please calibrate it with the equipment used in your application.

Note 6) The maximum speed varies depending on the operating conditions (load mass, positioning distance).

Note 7) The weight of the Card Motor itself. Controllers and cables are not included.

2.2 Controller (LATCA)

Item	Specifications	
Input type <small>Note 1)</small>	Step data input type	Pulse input type
Compatible motor	LAT3 series	
Number of axis per controller	Single axis	
Control method	Closed-loop control with encoder feedback signal	
Power supply specifications <small>Note 2)</small>	Power supply voltage: 24 VDC +/-10% Current consumption: 2 A (Maximum 3 A) <small>Note 3)</small> Power consumption: 48 W (Maximum 72 W) <small>Note 3)</small>	
Operation patterns	Positioning operation Pushing operation Automatic return to origin	Pulse sequence operation Pushing operation Automatic return to origin
Number of step data	15	4
Parallel input	6 inputs (Optically isolated. Pulse input terminals and COM terminal are excluded.)	
Parallel output	4 outputs (Optically isolated, open collector output)	
Pulse input mode	Open collector input	Differential input
Power supply voltage for pulse input signal	24V	5V
Maximum pulse frequency	100 kHz	200 kHz
Pulse input mode	Pulse and Direction CW and CCW Quadrature	
Serial communication	RS-485	
Position display output <small>Note 4)</small>	A-phase and B-phase pulse signals, RESET signal (NPN open collector output)	
LED display	2 LED's (Green and Red)	
Operating temperature range	0 to 40°C (No condensation)	
Operating humidity range:	90 % or less (No condensation)	
Storage temperature range (°C)	-10 to 60°C (No condensation, no freezing)	
Storage humidity range	90% or less (No condensation)	
Insulation resistance	50 MΩ (500 VDC) between the case and FG	
Weight <small>Note 5)</small>	130 g (Direct mounting type) 150 g (DIN rail mounting type)	

Note 1) Step data input type or pulse input type can be selected using the configuration software.

Note 2) Do not use a power supply with "inrush current control" for the controller power supply.

Note 3) Rated current: Current consumption when continuous thrust is generated.

Peak current: Current consumption when maximum instantaneous thrust is generated.

Note 4) Specification for the connection of the CEU5 Multi-counter (supplied separately).

Note 5) Cables are not included.

3 General Instructions

3.1 Wiring

Warning

- Adjusting, mounting or wiring change should not be done before disconnecting the power supply to the product.
- Electrical shock, malfunction and damage can result.
- Do not disassemble the cables.
- Use only specified cables.
- Do not connect or disconnect the wires, cables and connectors when the power is turned on.

Caution

- Wire the connector securely.
Check the connector for polarity and do not apply any voltage to the terminals other than those specified in the Operation Manual.
- Take appropriate measures against noise.
Noise in a signal line may cause malfunction. As a countermeasure separate the high voltage and low voltage cables, and shorten the wiring lengths, etc.
- Do not route input/output wires and cables together with power or high voltage cables.
The product can malfunction due to interference of noise and surge voltage from power and high voltage cables to the signal line. Route the wires of the product separately from power or high voltage cables.
- Take care that actuator movement does not catch cables.
- Operate with all wires and cables secured.
- Avoid bending cables at sharp angles where they enter the product.
- Avoid twisting, folding, rotating or applying an external force to the cable.
Risk of electric shock, wire breakage, contact failure and loss of control of the product can happen.
- Select "Robotic cables" in applications where cables are moving repeatedly (encoder/ motor/ lock).
Refer to the relevant operation manual for the bending life of the cable.

- Confirm correct insulation of the product.

Poor insulation of wires, cables, connectors, terminals, etc. can cause interference with other circuits. Also, there is the possibility that excessive voltage or current may be applied to the product causing damage.

3.2 Transportation

Caution

- Do not carry or swing the product by the cables.

3.3 Mounting

Warning

- Observe the tightening torque for screws.
Unless stated otherwise, tighten the screws to the recommended torque for mounting the product.
- Do not make any alterations to this product.
Alterations made to this product may lead to a loss of durability and damage to the product, which can lead to human injury and damage to other equipment and machinery.
- When an external guide is used, connect the moving parts of the product and the load in such a way that there is no interference at any point within the stroke.
Do not scratch or dent the sliding parts of the table or mounting face etc., by striking or holding them with other objects. The components are manufactured to precise tolerances, so that even a slight deformation may cause faulty operation or seizure.
- Do not use the product until you verify that the equipment can be operated correctly.
After mounting or repair, connect the power supply to the product and perform appropriate functional inspections to check it is mounted correctly.
- When attaching to the work piece, do not apply strong impact or large moment.
If an external force over the allowable moment is applied, it may cause looseness in the guide unit, an increase in sliding resistance or other problems.
- Maintenance space
Allow sufficient space for maintenance and inspection.

3 General Instructions (continued)

3.4 Handling

Warning

- Do not touch the motor while in operation.
The surface temperature of the motor can increase to approx. 90°C to 100°C due to operating conditions.
Energizing alone may also cause this temperature increase.
As it may cause burns, do not touch the motor when in operation.
- If abnormal heating, smoking or fire, etc. occurs in the product, immediately turn off the power supply.
- Immediately stop operation if abnormal operation noise or vibration occurs.
If abnormal operation noise or vibration occurs, the product may have been mounted incorrectly. Unless operation of the product is stopped for inspection, the product can be seriously damaged.
- Never touch the rotating part of the motor or the moving part of the actuator while in operation.
There is a serious risk of injury.
- When installing, adjusting, inspecting or performing maintenance on the product, driver and related equipment, be sure to turn off the power supply to each of them. Then, lock it so that no one other than the person working can turn the power on, or implement measures such as a safety plug.

Caution

- Keep the driver and product combined as delivered for use.
The product parameters are set before shipment.
If it is combined with a different product, parameter failure can result.

Caution

- Check the product for the following points before operation.
 - Damage to electric driving line and signal lines.
 - Looseness of the driver to each power line and signal line.
 - Looseness of the actuator/cylinder and driver mounting.

- Abnormal operation.
- Stop function
- When more than one person is performing work, decide on the procedures, signals, measures and resolution for abnormal conditions before beginning the work.
- Also designate a person to supervise the work, other than those performing the work.
- An operation test should be performed at low speed, start the test at a predefined speed, after confirming there are no problems.
- Actual speed of the product will be changed by the workload.
Before selecting a product, check the catalogue for the instructions regarding selection and specifications.
- Do not apply a load, impact or resistance in addition to a transferred load during return to origin.
In the case of the return to origin by pushing force, additional force will cause displacement of the origin position since it is based on detected motor torque.
- Do not remove the nameplate.

3.5 Unpacking

Caution

- Check the received product is as ordered.
If a different product is installed from the one ordered, injury or damage could result.

4 Installation

4.1 Installation

Warning

- Do not install the product unless the safety instructions have been read and understood.

4.2 Environment

4.2.1 Card Motor

Caution

- Do not use the products in an area where they could be exposed to dust, metallic powder, machining chips or splashes of water, oil or chemicals.
- Do not use the products in a magnetic field.** Otherwise, the ambient magnetic field may affect the motor and malfunction and damage could result.
- Do not expose the product to strong light sources, such as direct sunlight.**
- The Card Motor uses an optical sensor to detect the position, so if it is exposed to a strong light source such as direct sunlight, a malfunction could result. In such a case, install a light shielding cover to shield the sensor from light.
- Do not use the products in an environment where flammable, explosive or corrosive gases, liquids or other substances are present.
- Avoid heat radiation from strong heat sources, such as direct sunlight or a hot furnace.
- Do not use the products in an environment with cyclic temperature changes.
- The base oil of the grease can dissipate depending on the external environment and operating conditions. This may reduce the lubrication performance and shorten the life of the equipment.

4.2.2 Controller and Peripheral Devices

Caution

- Do not use the products in an area where they could be exposed to dust, metallic powder, machining chips or splashes of water, oil or chemicals.

- Do not use the products in a magnetic field.
- Do not use the products in an environment where flammable, explosive or corrosive gases, liquids or other substances are present.
- Avoid heat radiation from strong heat sources, such as direct sunlight or a hot furnace.
- Do not use the products in an environment with cyclic temperature changes.
- Do not use the products in an environment where surges are generated.** Devices that generate a large amount of surge around the product (e.g. solenoid type lifters, high frequency induction furnaces, motors, etc.) may lead to deterioration or damage to the internal components of the products. Avoid supplies of surge generation as well as crossed power and signal lines.
- The Card Motor and the controller are not immune to lightning strikes.
- Do not install these products in a place subject to vibration and impact. It will cause damage or malfunction.
- If this product is used to drive a relay or solenoid, please use a voltage surge absorbing element.

4.3 Mounting

4.3.1 Card Motor

Warning

- The Card Motor contains a strong rare-earth magnet. If magnetized work pieces, tools and metallic parts are brought in the vicinity of the Card Motor, they will be attracted, which could cause injury to operators and damage the equipment. Take special care when handling and operating the product.
- Do not make any alterations or modification to this product.
- When an external guide is used, connect the moving part of the actuator and the load in such a way that there is no contact at any point along the stroke.

4 Installation (continued)

- Do not use the product until you have verified that the equipment can operate properly.** After mounting or repair, connect the power supply to the product and perform appropriate functional inspections to ensure it is mounted properly.
- When mounting a work piece, do not apply an impact or large moment to the Card Motor.** If an external force higher than the allowable moment is applied, it may cause play in the guide part and an increase in the sliding friction or other damage.
- Do not scratch or damage any sliding part by hitting with an object.** The components are manufactured to high precision. Therefore even a slight deformation may cause operation failure.
- The flatness of the mounting surface of the table and rail must be 0.02 mm or less.** Insufficient flatness of the mounting base for the Card Motor, or of a work piece mounted to it can cause play in the guide and an increase in the sliding friction.

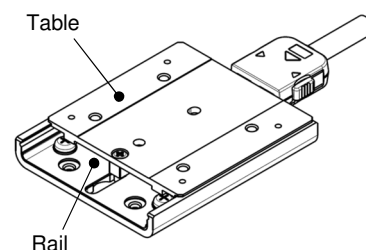

Caution

- Mount the Card Motor on a base with good cooling performance, for example a metal plate.** If the cooling performance is not adequate, the temperature of the Card Motor will increase, which may cause damage.

- Do not apply strong impact or excessive moment while mounting a work piece.** The product may overheat during operation and a temperature error or failure may occur.
- When mounting the Card Motor, use stainless steel screws with appropriate length and tighten with recommended tightening torque.** If the maximum screw-in depth is exceeded, it may damage the internal components. Using a tightening torque higher than the specified torque may cause malfunction, and using a lower tightening torque may displace the work piece or cause it to drop off.

1) Body mounting from the bottom / tapped type

Screw material	SUS
Screw dimensions	M3 x 0.5
Recommended tightening torque [N·m]	0.48 to 0.63
L1 (Maximum screw-in depth) [mm]	4.6
L2 (Plate thickness) [mm]	2.1

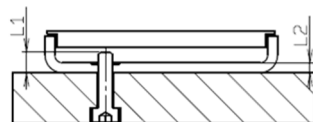

2) Body mounting from above / through hole type

Screw material	SUS
Screw dimensions	M2.5 x 0.45
Recommended tightening torque [N·m]	0.27 to 0.36
L3 (Maximum screw-in depth) [mm]	2.5
L4 (Plate thickness) [mm]	2.1

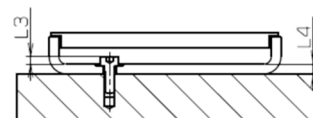

4 Installation (continued)

3) Work piece mounting / top mounting type

Screw material	SUS
Screw dimensions	M3 x 0.5
Recommended tightening torque [N·m]	0.48 to 0.63
L5 (Maximum screw-in depth) [mm]	2.5

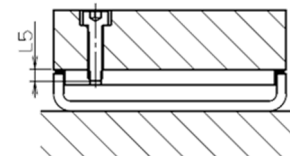

- When connecting the cables, avoid applying any stress to the connector from the cable side.** If an external force or vibration is applied to the connector, damage may result. Do not bend the cable for approximately 20 mm from the connector and fix this part of the cable with a cable fixture.
- Locating the rail to the mounting surface and locating the work piece onto the table using the dowel pin holes on the rail and table.**

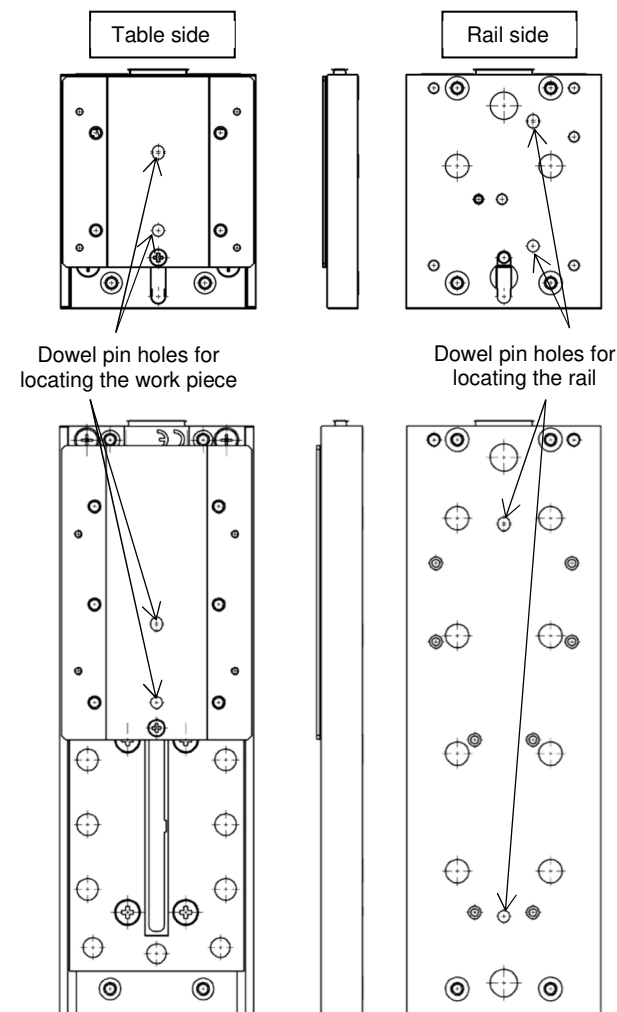

4.3.2 Controller

Warning

- Install the controller and its peripheral devices on fireproof material.** Direct installation on or near flammable material may cause fire.
- Do not install these products in a place subject to vibration and impact.
- Do not mount the controller and its peripheral devices on the same base together with a large-sized electromagnetic contactor or circuit breaker (fuse) that generate vibration. Mount them on different base plates, or keep the controller and its peripheral devices away from such sources of vibration.
- Install the controller and its peripheral devices on a flat surface.** If the mounting surface is not flat or uneven, excessive force may be applied to the housing and other parts resulting in malfunction.

4 Installation (continued)

- Make the size of the control panel and the installation so that the surrounding temperature of the controller is 40°C or less.
- Mount the controller vertically on the wall with 30 mm or more free space on the top and bottom of the controller as shown below.
- Leave 60 mm or more free space between the front of the controller and the control cabinet door (lid) for inserting and removing connectors.
- Leave enough space around the controllers so that the operating temperature of the controller stays within the specified range.

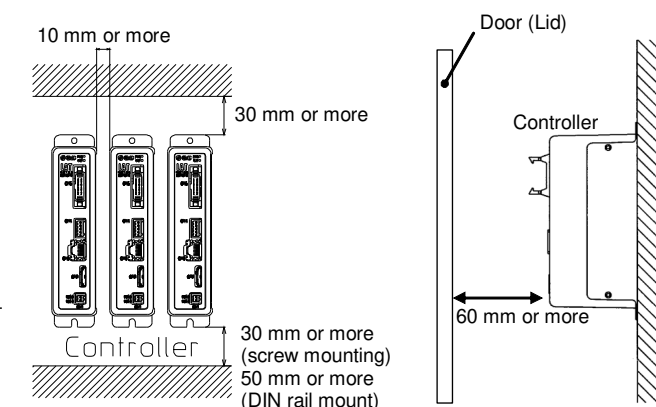

4.4 Wiring

Warning

- Switch the power supply off before wiring or plugging and unplugging of connectors. Mount a protective cover over the terminals after the wires have been connected.**
- Do not route the digital I/O signal and power cables together.** Malfunctions stemming from noise may occur if the digital I/O signal and power cables are routed together.

- Confirm proper wiring before switching the power on.** Incorrect wiring will lead to malfunction or may damage the controller or its peripheral devices. Confirm that there is no mis-wiring before turning the power on.
- Leave enough space for the routing of the cables** If the cables are forced into unreasonable positions, it may damage the cables and connectors, which may lead to misconnection or short-circuit and result in malfunction. Avoid bending the cables in sharp angles close to the connectors or where they enter the product. Fix the cable as close as possible to the connectors so that mechanical stress cannot be applied to the connectors.

4.5 Grounding

Warning

- Always ground the Card Motor.**
- Make sure the product is grounded to ensure the noise tolerance of the controller.** Otherwise it may cause malfunction, damage, electric shock or fire. Do not share the earth with devices or equipment that generate a strong electromagnetic noise.
- Use a dedicated grounding.** Use a D-class grounding. (Ground resistance less than 100 Ω).
- The grounding point should be as close as possible to the actuator, and the ground wires as short as possible.
- In the unlikely event that malfunction may be caused by the ground, it may be disconnected.

4 Installation (continued)

4.6 Connecting

4.6.1 Power Supply Connector: CN1

The power supply plug is an accessory (supplied with the controller). Use an AWG20 (0.5 mm²) cable for connecting the power supply plug to a 24 VDC power supply.

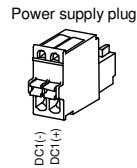

Terminal	Function	Description
DC1(-)	Power supply (-)	Terminal for the negative (-) power supply to the controller.
DC1(+)	Power supply (+)	Terminal for the positive (+) power supply to the controller.

4.6.2 Counter Connector: CN4

The counter plug is an accessory (supplied with the controller). Use the counter cable for connecting the counter to the counter plug.

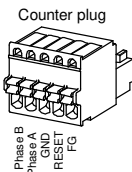

Terminal	Details	Wire colour
Phase B	Connect the phase B wire of the counter cable	White
Phase A	Connect the phase A wire of the counter cable	Red
GND	Connect the GND wire of the counter cable	Light gray
RESET	Connect the Reset wire of the counter cable	Yellow
FG	Connect the FG wire of the counter cable	Green

4.6.3 Parallel I/O connector: CN5

Use the I/O cable to connect a PLC, etc., to the CN5 parallel I/O connector. The wiring is specific to the type of parallel I/O (NPN or PNP). Please refer to the wiring diagrams below for correct wiring of NPN and PNP type controllers.

NPN output circuit

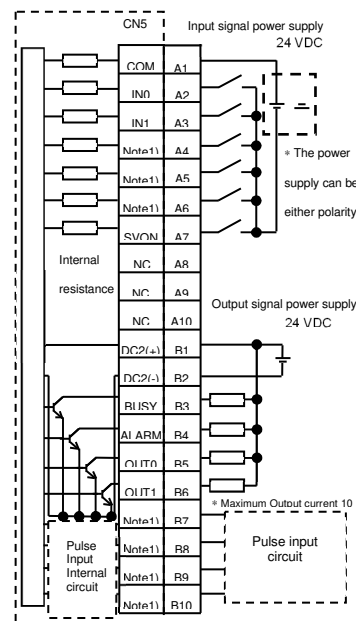

PNP output circuit

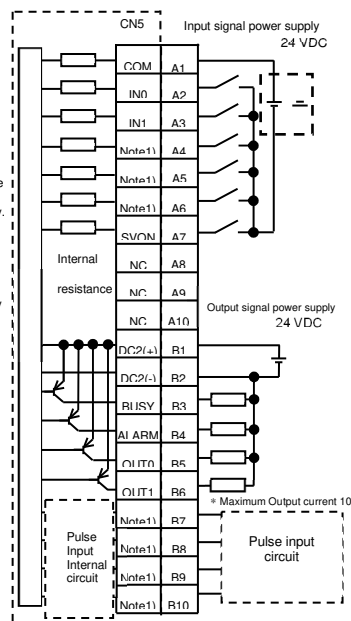

Note1)

Terminal number	Function	
	Step data input type	Pulse input type
A4	IN2	SETUP
A5	IN3	CLR
A6	DRIVE	TL
B7	NC	PP+
B8	NC	PP-
B9	NC	NP+
B10	NC	NP-

Note2) When the step data input method is used, do not connect wires to the terminals B7 to B10. Internal circuits are included which are used as pulse input signal terminals.

4 Installation (continued)

Input signal details

Name	Details
COM	Connect a 24VDC power supply for the input signals. (Polarity is reversible).
IN0 to IN3	Selection of step data number specified by a Bit No. (combinations of IN0 to IN3)
DRIVE	Command to drive the motor.
SVON	Command to turn the servo motor ON.
SETUP	Command to move to the origin position.
CLR	Command to reset the pulse signal.
TL	Command to change the pushing operation.
PP+ to NP-	These are the pulse input signals for operation command.
NC	Not connected.

Output signal details

Name	Details
DC2(+)	Connect the 24V power supply terminal for the output signals.
DC2(-)	Connect the 0V power supply terminal for the output signals.
BUSY	ON when the actuator is moving.
ALARM	OFF when an alarm has been generated. ^{Note1)}
OUT0 to OUT1	OUT0:Default output for the INP(in position) signal. ^{Note2)} OUT1:Currently not used.
NC	Not connected.

Note1) Output is ON when power is supplied to the controller, and OFF when an alarm is generated.
Note2) INP signal (OUT0) is turned ON when the actuator comes close to the target position.

Pulse input circuit example

i. Open collector input for 1-pulse mode (Pulse and Direction)

Power supply for pulse input signal (24 V or 5 VDC)

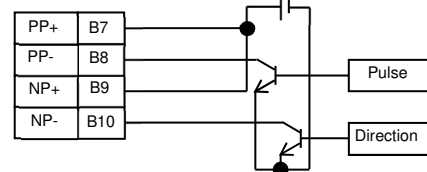

ii. Open collector input for 2-pulse mode (CW and CCW or Quadrature)

Power supply for pulse input signal (24 V or 5 VDC)

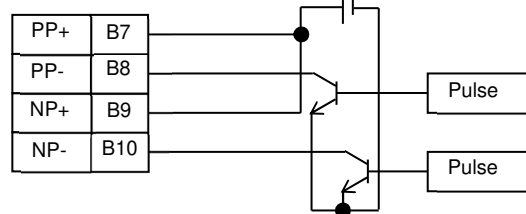

iii. Differential input of 1-pulse mode (Pulse and Direction)

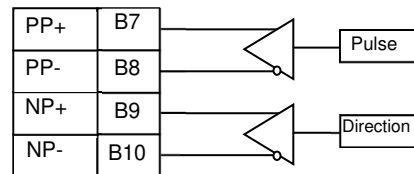

vi. Differential input of 2-pulse mode (CW and CCW or Quadrature)

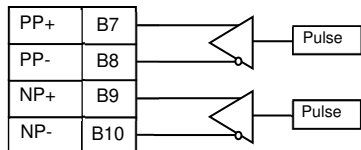

4.8 I/O cable

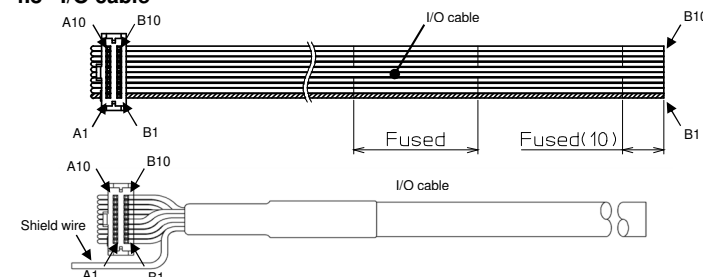

4 Installation (continued)

Parallel I/O Plug Terminal List

Terminal number	Function	
	STEP data input type	Pulse input type
A1	COM	
A2	IN0	
A3	IN1	
A4	IN2	SETUP
A5	IN3	CLR
A6	DRIVE	TL
A7	SVON	
A8	NC	
A9	NC	
A10	NC	

Terminal number	Function	
	STEP data input type	Pulse input type
B1	DC2(+)	
B2	DC2(-)	
B3	BUSY	
B4	ALARM	
B5	OUT0	
B6	OUT1	
B7	NC	PP+
B8	NC	PP-
B9	NC	NP+
B10	NC	NP-

4.9 Power Supply

Warning

- Use a power supply with low noise between lines and between power and ground. In cases where noise is high, use an isolation transformer.
- The power supplies for the controller and for the parallel I/O should be separate, and both power supplies must not be of "inrush-current limited" type. If the power supply is of "inrush-current limited" type, a voltage drop may occur during the acceleration or deceleration of the actuator.
- Take appropriate measures to prevent surges from lightning. Ground the surge absorber for lightning separately from the grounding of the controller and its peripheral devices.
- Use a UL certified product listed below as the direct current power supply.

1) Limited voltage current circuit in accordance with UL508.

A circuit to which power is supplied by the secondary coil of an insulated transformer that meets the following conditions:

- Maximum voltage (No load): 30 Vrms (42.4 V peak) or less
- Maximum current: 8 A or less (including short circuit)

Limited by circuit protector (such as fuse) with the following ratings.

Voltage without load (V peak)	Maximum current rating (A)
0 to 20 [V]	5.0
Over 20 [V] up to 30 [V]	100 Peak voltage

2) Circuit (class 2) with maximum 30 Vrms (42.4 V peak) or less, which uses class 2 power supply unit in accordance with UL1310 or class 2 transformer in accordance with UL1585 as the power supply.

5 Settings

5.1 Setting and operation

In order to move the Card Motor to a specific position, it is necessary to set the operation patterns in the LATC4 controller using a PC with the controller setting software installed, or using the teaching box. The sequence of the step data set in the controller is programmed and controlled using a PLC connected to the controller. Refer to the LATC4 series controller operation manual for details of the step data setting procedure, step data selection using a PLC and operation instructions.

5.2 Controller LED's

If the [ALM] LED on the front of the controller turns red or flashes, an alarm has been generated. Switch the SVON signal OFF and ON again for at least 2ms to reset and cancel the alarm after the cause of the alarm has been cleared.

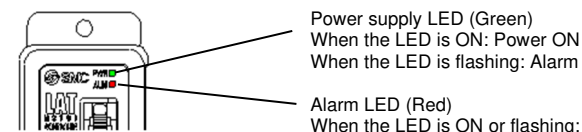

Refer to the LAT3 operation manual for a list of alarm patterns and causes.

6 How to Order

- Refer to the catalogue or operation manual on the SMC website (URL: <https://www.smcworld.com>) for the How to Order information.

7 Outline Dimensions

- Refer to the catalogue or operation manual on the SMC website (URL: <https://www.smcworld.com>) for the Outline Dimensions.

8 Maintenance

8.1 General Maintenance

Caution

- Failing to follow proper maintenance procedures could cause the product to malfunction and lead to equipment damage.
- If handled improperly, machinery and equipment can be dangerous. Maintenance of electromechanical systems should be performed only by qualified personnel.
- Before performing maintenance, turn off the power supply and be sure there is no accumulated voltage.
- After installation and maintenance, perform an appropriate functional inspection and test to make sure the equipment is installed correctly.
- Do not make any modification to the products.
- Do not disassemble the products, unless required by installation or maintenance instructions.

8.2 Card Motor Maintenance

Warning

Before performing installation, wiring and maintenance, check for accumulated voltage using a tester at least 5 minutes after the power supply has been switched off.

Caution

- Perform regular maintenance and inspections. Confirm that there is no twisting of wires, play in the table or large sliding friction. This may result in malfunction.
- Conduct an appropriate functional inspection and test after completed maintenance. Stop operation if a device or equipment does not work correctly. Safety cannot be assured in the event of unexpected malfunction. Conduct a test of the emergency stop to confirm the safety of the equipment.
- Do not disassemble, modify or repair the products.
- When the equipment is serviced, first confirm that measures are in place to prevent dropping of driven objects and loss of equipment, etc., and then cut the power supply from the system. Confirm safety before restarting the equipment.

9 Limitations of Use

9.1 Limited warranty and disclaimer/compliance requirements

Refer to Handling Precautions for SMC Products.

10 Product disposal

This product should not be disposed of as municipal waste. Check your local regulations and guidelines to dispose of this product correctly, in order to reduce the impact on human health and the environment.

11 Contacts

Refer to www.smcworld.com or www.smc.eu for your local distributor / importer.

SMC Corporation

URL: <http://www.smcworld.com> (Global) <http://www.smc.eu> (Europe)
 *SMC Corporation, 4-14-1, Sotokanda, Chiyoda-ku, Tokyo 101-0021, Japan
 Specifications are subject to change without prior notice from the manufacturer.
 © 2021 SMC Corporation All Rights Reserved.
 Template DKP50047-F-085M