

## Instruction Manual Ionizer - Fan type IZF10R series

The intended use of this product is to neutralize charged objects.

### 1 Safety Instructions

These safety instructions are intended to prevent hazardous situations and/or equipment damage. These instructions indicate the level of potential hazard with the labels of "Caution," "Warning" or "Danger."

They are all important notes for safety and must be followed in addition to International Standards (ISO/IEC)<sup>1)</sup>, and other safety regulations.

<sup>1)</sup> ISO 4414: Pneumatic fluid power - General rules relating to systems.

ISO 4413: Hydraulic fluid power - General rules relating to systems.

IEC 60204-1: Safety of machinery - Electrical equipment of machines. (Part 1: General requirements)

ISO 10218-1: Robots and robotic devices - Safety requirements for industrial robots - Part 1: Robots.

Refer to product catalogue, Operation Manual and Handling Precautions for SMC Products for additional information.

Keep this manual in a safe place for future reference.

	<b>Caution</b>	Indicates a hazard with a low level of risk, which if not avoided, could result in minor or moderate injury.
	<b>Warning</b>	Indicates a hazard with a medium level of risk, which if not avoided, could result in death or serious injury.
	<b>Danger</b>	Indicates a hazard with a high level of risk, which if not avoided, will result in death or serious injury.

### Warning

- Always ensure compliance with relevant safety laws and standards.
- All work must be carried out in a safe manner by a qualified person in compliance with applicable national regulations.
- Use within the specified voltage and temperature limits.  
Voltage outside of the specification may cause malfunction, damage, electric shock and/or fire.
- This product does not have an explosion-proof construction.  
Do not use this product in areas where dust explosion might be triggered or where flammable or explosive gas is present.

### 2 Specifications

#### 2.1 Ionizer Specifications

Model	IZF10R	IZF10R-P
Air Flow	0.80 m <sup>3</sup> /min max.	
Ion generation method	Corona discharge	
Applied voltage method	DC	
Discharge output	±5 kV	
Offset voltage (Ion balance)	Within ±13 V	
Power supply voltage	24 VDC ±10%	
Current consumption	270 mA max.	
Switch Output	Type	NPN open collector / PNP open collector
	Load current	150 mA max.
	Residual voltage	1 V max. (at 150 mA)
	Max. load voltage	26.4 VDC / -
Ambient temperature	0 to 50°C (no freezing)	
Storage temperature	-10 to 60°C	
Ambient humidity	35 to 80%RH (no condensation)	
Material	Case: ABS, stainless steel Emitter: Tungsten	
Weight	260 g (340 g with bracket)	

### 3 Installation

#### 3.1 Installation

#### Warning

- Do not install the product unless the safety instructions have been read and understood.
- Install only where there is adequate space for maintenance and wiring. When installing the electrical connector, ensure sufficient room is left for easy insertion and removal of the electrical cable and emitter. Do not install with sharp bends in the cable. Give consideration to the minimum bend radius, ensure the cable entries are straight, and do not apply stress to the electrical connectors. If the connectors or fittings are subject to mechanical stress, malfunctions such as broken wires or fire may occur.
- Install only on a flat surface.

A curved or uneven mounting surface may cause excessive force to be applied to the frame or case. This force, as well as a heavy impact (e.g. from dropping the ionizer) may result in damage and failure.

- Do not use in areas subject to electrical noise. It may cause malfunction, deterioration or damage to internal components. Take measures to prevent noise at source and avoid power and signal lines from coming into close contact.

- Tighten with the specified torque. Refer to the mounting details for the correct tightening torque. If the tightening torque is exceeded the mounting screws and brackets may become loose.

- Do not touch the emitters with fingers or a metal tool. If the emitters are touched with fingers, injury or damage may result or if the emitters are touched with metal tools damage may result. This may interfere with the specified function and performance, but may also cause operational failure or an accident.

- Be sure to install or adjust the product with the power supply turned off.

#### Caution

- Be sure to check the effect of static charge removal after installation.

The effectiveness of static charge removal varies depending on the installation and operating conditions.

#### 3.2 Environment

#### Warning

- Do not use in an environment where corrosive gases, chemicals, salt water or steam are present.
- Do not use in an explosive atmosphere.
- Do not expose to direct sunlight. Use a suitable protective cover.
- Do not install in a location subject to vibration or impact. Check the product specifications.
- Do not mount in a location exposed to radiant heat.
- Use within the ambient temperature range.

The operating fluid and ambient temperature range for the Ionizer is 0 to 50°C.

In areas where sudden temperature changes occur, even when these changes are within the specified temperature range, condensation may form. The Ionizer should not be used in such conditions.

- Do not use this product in an enclosed space.

The product utilizes the corona discharge phenomenon. Since this process generates a small amount of ozone and NOx, only use the ionizer in open, well-ventilated areas.

- Environments to avoid

Do not use or store under the following conditions, as these may cause equipment failure:

- Ambient temperatures outside the range 0 to 50°C.
- Ambient humidity outside the range 35 to 85% RH.
- Areas where rapid temperature changes may cause condensation.
- Areas where corrosive gas, flammable gas or other volatile flammable substances are stored.
- Areas where the product may be exposed to conductive powder, such as, iron powder or dust, oil mist, salt, organic solvent, machining chips, particles or cutting oil.
- Directly in the path of air conditioners.

### 3 Installation (continued)

- In enclosed, poorly ventilated areas.
- Exposed to the direct sunlight and/or radiant heat.
- Areas where strong electromagnetic noise is generated (strong electric or magnetic fields, large surges).
- Areas where RF noise is generated.
- Areas prone to lightning strikes.
- Areas where the product is directly exposed to vibration and/or impact.
- Subject to weight or mechanical stresses that could cause deformation of the product.
- The Ionizer is not protected against lightning strikes. Protection against electrical surges due to lightning should be incorporated into the equipment.

#### 3.3 Installation and wiring

It is recommended to investigate environments where static electricity is generated and processes and parts where static electricity disturbance occur in advance, and thoroughly confirm the conditions in order to remove static electricity effectively before installation.

The effect of the ionizer varies depending on the surrounding installation conditions and operating conditions.

Confirm the effect of static electricity elimination after installation.

#### 3.4 Installation Precautions

Do not connect and disconnect connectors while the power is supplied. The product may be damaged and cause malfunction.

Do not attach tape or sealant on the product body. If the tape or sealant contains conductive adhesive or reflective paint, it is possible that due to the dielectric effect, a charge could build up causing an electro-static discharge or electrical leakage.

When installing the ionizer, ensure the air intake port side of the fan is at least 20mm away from any walls or obstructions. If there is an obstruction of the air intake port, the efficiency will be reduced due to ventilation resistance. Install the ionizer so that the cartridge case can be removed for maintenance and replacement of the emitters. When the emitters are cleaned or replaced, remove the two screws mounted on the cartridge case.

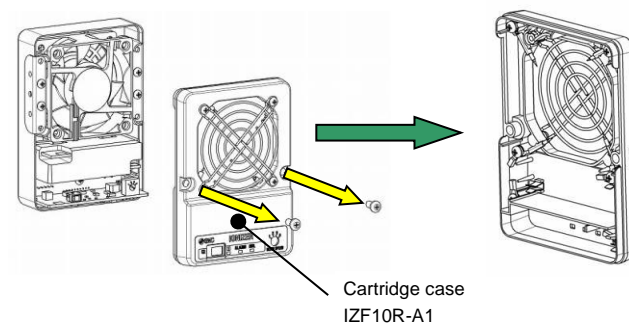

Do not touch the emitters with fingers or a metal tool. It may cause injury or malfunction.

If the emitters are touched with fingers, injury or damage may result, or if the emitters are touched with a metal tool, damage may result. This may interfere with the specified function and performance, but may also cause operational failure or an accident.

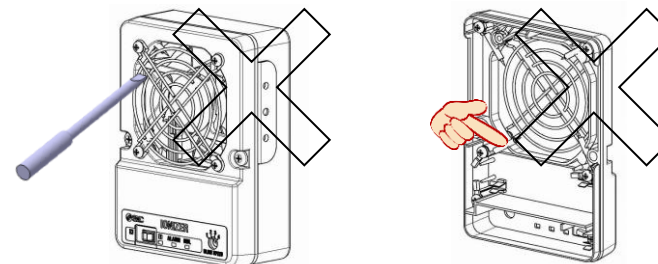

#### Caution High Voltage

This product contains a high voltage generation circuit. When performing maintenance inspection, be sure to confirm that the power supply to the ionizer is turned off. Never disassemble or modify the product, as this can cause loss of product functionality, and there is also a risk of electric shock and earth leakage.

### 3 Installation (continued)

#### 3.5 Mounting

1) Installation with bracket

When installing the ionizer with a bracket, secure it with M5 screws (not supplied) using the holes in the bottom of the bracket.

Refer to the Outline Dimensions in the operation manual for details.

The angle adjustment range of the bracket is 50 degrees in direction A and 90 degrees in direction B as shown.

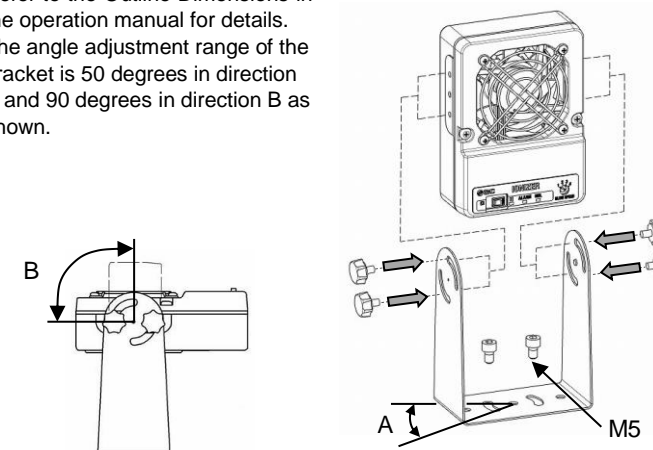

2) Installation without bracket

If a bracket is not used, install the product using the M4 screw holes on the sides of the body (screws are not supplied).

Refer to the Outline Dimensions in the operation manual for details.

M4 screw recommended tightening torque: 1.3 to 1.5 N·m.

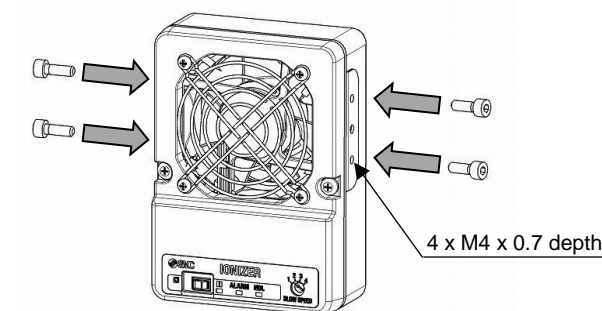

### 4 Wiring

#### 4.1 Wiring

#### Warning

- Check the capacity of the power supply is sufficient and the voltage is within the specified range before wiring.
- Always use a UL listed power supply specified by NEC (National Electric Code) with class 2 output or a limited power source in accordance with UL 60950.
- To maintain product performance, and to prevent electrical shock, connect a protective earth in accordance with instructions in this manual. Ensure that the resistance between the lead wire and Ground is less than 100Ω.
- Be sure to turn off the power supply when wiring (including the removal and mounting of the connector).
- When turning on the power supply, check the wiring and ambient conditions for safety.
- Do not remove or mount the connector wired to the power supply with the power supply ON. Otherwise, the product can malfunction.
- Be sure to check for correct wiring before operating the product. Incorrect wiring may lead to damage and malfunction of the product.

#### 4.2 Wiring diagram

Wire cables according to the circuit and wiring chart.

Be sure to connect the ground terminal (F.G.) with 100 Ω or less resistance to Ground.

The Ground terminal (F.G.) is used as a reference for the static electricity elimination. If the Ground terminal is not connected, it will not be able to gain an appropriate offset voltage.

## 4 Wiring (continued)

### NPN output

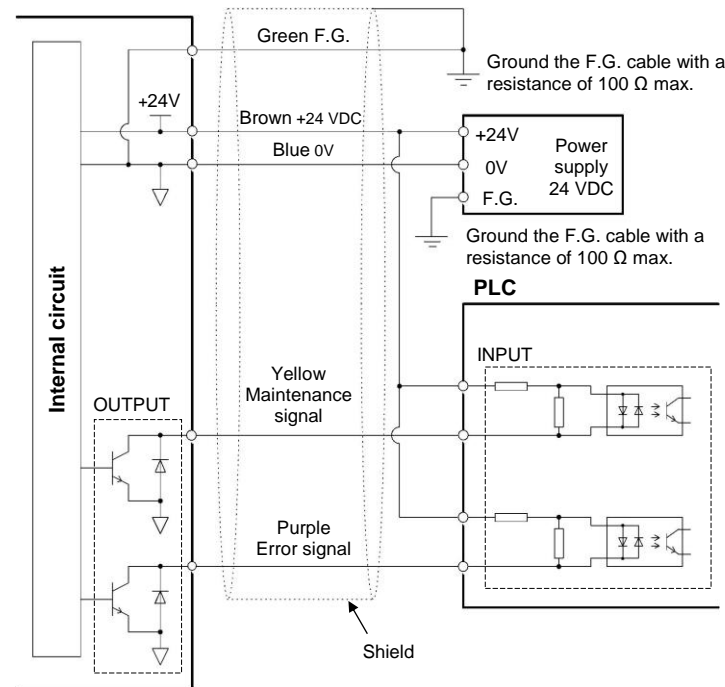

### PNP output

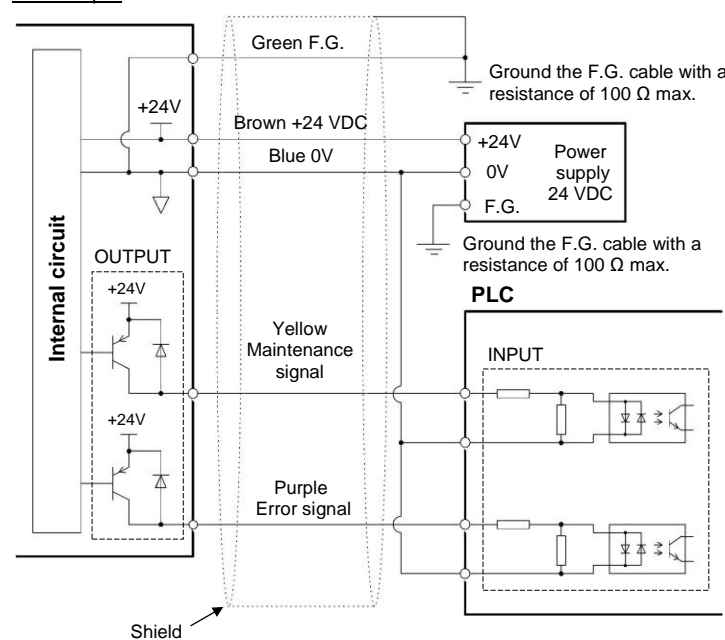

### 4.3 Power Supply cable wiring

The power supply cable bending radius should be greater than the minimum bending radius specified (10 mm) to avoid stress from being applied to the power supply connector. *Note) This is the minimum bend radius at 20°C.*

- Cut unused wires and insulate to prevent possible short circuits.

Pin No.	Wire colour	Signal name	Signal direction	Description
1	Brown	+24 VDC	IN	Power supply connection to operate the ionizer.
2	Blue	0 V	IN	
3	Green	F.G.	-	Ground connection (resistance 100Ω or less) for use as a potential reference for the ionizer.
4	Yellow	Maintenance signal	OUT (Contact A)	The maintenance signal turns ON when the emitter is contaminated or worn.
5	Purple	Error signal	OUT (Contact B)	The error signal turns OFF when a high voltage alarm or output signal over current is generated. (The signal is ON green when there is no problem.)

The connector is designed to accept 26 AWG wire.

## 4 Wiring (continued)

### 4.4 Wiring of the AC adapter

The green wire on the AC power cable must be connected to the ground terminal, F.G. The F.G. cable is the standard electric potential for static electricity neutralization. If the F.G. cable is not grounded properly, the optimal offset voltage (ion balance) cannot be obtained, which may damage the product or connected power supply.

#### IZF10-CG2

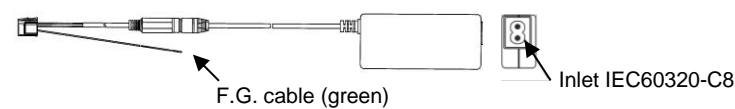

Note) The AC cable is not included in IZF10-CG2. Please prepare an AC cable that conforms to the standards for each country. The external output signal cannot be used when the AC adapter is used.

## 5 Functions

### 5.1 Summary of product parts

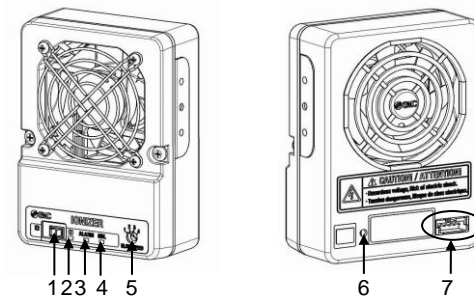

No	Name	Description
1	Power supply switch	Switch to turn the ionizer ON and OFF.
2	Power supply indicator	The LED is ON green when power is supplied to the ionizer, and the LED is ON orange during an incorrect high voltage alarm, or output signal over current alarm.
3	ALARM Error indicator	The LED is ON red when an incorrect voltage alarm is generated for 100 ms or more.
4	NDL Maintenance indicator	The LED is ON green when the emitter is contaminated or worn.
5	BLOW SPEED Air flow adjustment	Rotary switch for adjustment of the fan motor air flow. Refer to operation manual for details.
6	Balance adjustment	Trimmer for offset voltage (ion balance) adjustment. Refer operation manual for details.
7	Connector	Connect the power supply cable or AC adapter.

### 5.2 Alarm function

If abnormal functioning occurs during operation of the ionizer, the user is alerted by the external output signal or LED operation.

Alarm	Output	LED ON	Operation after Alarm	Description	Action to Reset Alarm
Incorrect high voltage	Error signal OFF (Contact B)	Power supply (Orange) Error (Red)	Stop	Incorrect high voltage discharge for more than 100 ms.	Supply power again
Excess output current	Error signal OFF (Contact B)	Power supply (Orange)	Continue	Excess current present at the output.	Reset automatically
Maintenance warning	Maintenance signal ON (Contact A)	Maintenance (Green)	Continue	Static electricity neutralization function reduced due to dirt, wear or damage to the emitters.	Supply power again

Refer to the operation manual or catalogue on the SMC website (URL: <https://www.smcworld.com>) for further details about the "Alarm function".

## 6 Settings

### 6.1 Adjustment of offset voltage (ion balance)

- Although the offset voltage (ion balance) has been factory adjusted, re-adjustment may be required depending on the installation environment.
- The offset voltage can be adjusted using the balance adjustment trimmer. When adjusting the offset voltage (ion balance), use a measuring instrument such as a charge plate monitor.
- Rotating the balance adjustment trimmer in a clockwise direction will increase the positive ions and rotating it in a counter-clockwise direction will increase the negative ions.
- The angle adjustment range of the balance adjustment trimmer is 270 degrees. If the adjustment trimmer is rotated beyond the angle adjustment range, it may damage the trimmer.

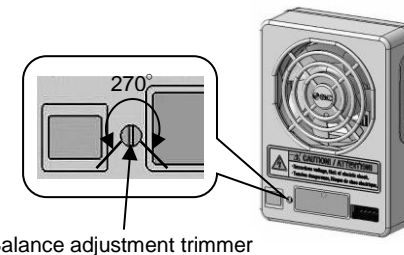

### 6.2 Air flow adjustment

- The air flow can be adjusted using the air flow adjustment rotary switch (BLOW SPEED). Adjust the air flow adjustment switch with a small flat blade screwdriver.
- The adjustment range of the air flow adjustment switch is 108 degrees. If the adjustment switch is rotated beyond the adjustment range, this may damage the switch. If the air flow adjustment switch is placed between the markers, the fan motor may stop.
- Details of the air flow adjustment switch markers and the air flow rate are shown in the table below.

Scale	Airflow [m <sup>3</sup> /min]
1	0.19
2	0.46
3	0.66
4	0.80

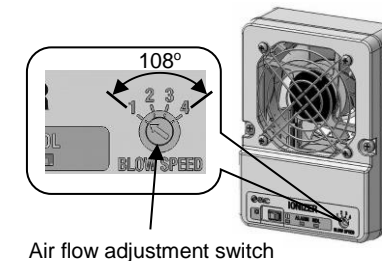

## 7 How to Order

Refer to the operation manual or catalogue on the SMC website (URL: <https://www.smcworld.com>) for "How to Order" information

## 8 Outline Dimensions (mm)

Refer to the operation manual or catalogue on the SMC website (URL: <https://www.smcworld.com>) for "Outline dimensions".

## 9 Maintenance

### 9.1 General Maintenance

#### Caution

- Not following proper maintenance procedures could cause the product to malfunction and lead to equipment damage.
- Before performing maintenance, turn OFF the power supply.
- After installation and maintenance, apply power to the equipment and perform appropriate functional tests to make sure the equipment is installed correctly.
- Do not make any modification to the product.
- Do not disassemble the product, unless required by installation or maintenance instructions.

## 9 Maintenance (continued)

### 9.2 Specific Recommendations

#### Warning

- **Perform maintenance regularly and clean the emitters.** It is recommended to perform maintenance every week or when the maintenance warning signal turns ON. Periodically inspect the electrostatic sensor to check that it is operating under suitable conditions. If the product is used for an extended period for example with dust present on the emitters, the product performance will be reduced. If the emitter becomes worn and the product performance is not restored after cleaning, replace the cartridge case.

### 9.2.1 Maintenance Warning Function and Cleaning

This product incorporates a maintenance warning function which constantly monitors the emitters and warns of a reduction of the performance in the static electricity neutralization. Clean the emitters with cleaning kit [IZS30-M2] or use a cotton bud soaked in alcohol. If a cleaning kit is not available, saturate a cotton swab with alcohol to clean the emitters. The industrial alcohol to be used should be reagent ethanol class 1 (99.5 vol% or greater). Before cleaning the emitters, make sure that the power supply is OFF and confirm that the fan motor has stopped. Never perform cleaning or replace the emitters when the fan motor is rotating. If the emitter becomes worn and the product performance is not restored after cleaning, replace the cartridge case.

### 9.2.2 Replacement of Cartridge case

- 1) Be sure to disconnect the power supply before installation and cleaning. The fan motor rotation will not stop immediately due to inertial force even when the power is OFF. Confirm that it has stopped before moving to the next step.
- 2) Remove the two screws to remove the cartridge case.

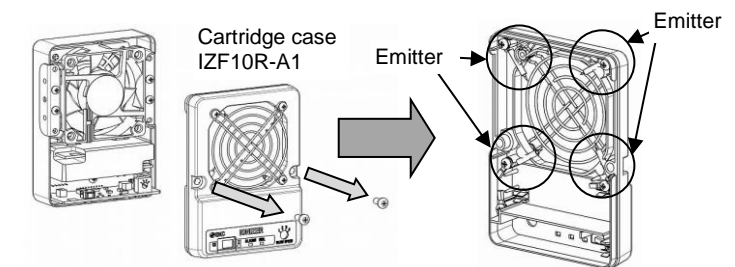

- 3) Four emitters are mounted in the cartridge case enclosure, and the end of each of the emitters should be cleaned. Make sure that all four emitters are cleaned.
- 4) Put the cartridge case back in its original position by following the removal procedure in reverse (tightening torque: 0.7 to 0.8 N·m). Take care not to get the wires caught in the enclosure when remounting.

## 10 Limitations of Use

### 10.1 Limited warranty and disclaimer/compliance requirements

Refer to Handling Precautions for SMC Products.

## 11 Product Disposal

This product shall not be disposed of as municipal waste. Check your local regulations and guidelines to dispose this product correctly, in order to reduce the impact on human health and the environment.

## 12 Contacts

Refer to [www.smcworld.com](https://www.smcworld.com) or [www.smc.eu](https://www.smc.eu) for your local distributor / importer.

# SMC Corporation

URL : <https://www.smcworld.com> (Global) <https://www.smc.eu> (Europe)  
 SMC Corporation, 4-14-1, Sotokanda, Chiyoda-ku, Tokyo 101-0021, Japan  
 Specifications are subject to change without prior notice from the manufacturer.  
 © 2021 SMC Corporation All Rights Reserved.  
 Template DKP50047-F-085M