

Type 3 Integrated input-output type

Fieldbus System (For Input/Output)

EX250 Series

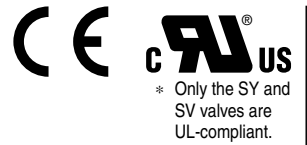

Compatible Protocols

DeviceNet™ PROFIBUS® CC-Link ASi[®] INTERAC[®]
 CANopen EtherNet/IP™

Made to Order → Modbus CC-Link IE Field™

- ★ Enclosure IP67
- ★ Maximum 32 inputs/32 outputs
- ★ Sensors with M8/M12 connectors can be connected.

Manifold Solenoid Valves

SY3000/5000/7000

VQC1000/2000/4000/5000

S0700

SV1000/2000/3000

Type 1	EX260
Type 1	EX123/124/126
Type 2	EX500
Type 3	EX600
Type 3	EX245
Type 3	EX250
Type 1	EX120/121/122
Type 1	EX140
Type 1	EX180
Type 2	EX510
Type 2	M8/M12
Type 2	ATEX

CONTENTS

Type 3 Integrated input-output type

Fieldbus System (For Input/Output) EX250 Series

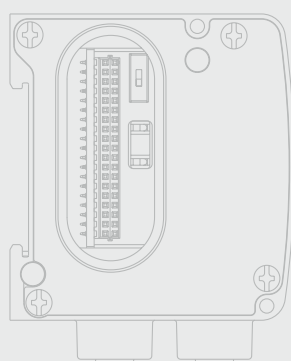
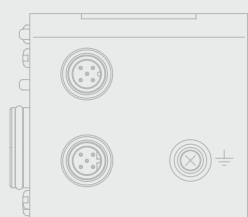
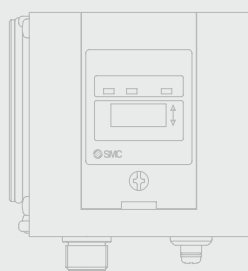

Parts Structure	p. 148
SI Unit	
How to Order	p. 148
Specifications	p. 149
Dimensions/Parts Description	p. 150
LED Indicator	p. 152

Input Block	
How to Order	p. 153
Specifications	p. 153
Dimensions/Parts Description	p. 154
LED Indicator	p. 155
Internal Circuit	p. 155

Accessories	
Example of Connections	p. 156
① Replacement Fuse	p. 157
② End Plate (Input side)	p. 157
③ Output Block	p. 158
④ Power Block	p. 158
⑤ End Plate (Output side)	p. 161
⑥ Communication Cable	p. 162
⑦ Field-wireable Communication Connector	p. 164
⑧ Power Supply Cable (For SI unit/For power block)	p. 164
⑧ Power Supply Cable (For SI unit)	p. 165
⑨ Cable for Output Entry	p. 165
⑩ Seal Cap (10 pcs.)	p. 165
⑪ Power Supply Cable (For connecting the SI unit to the power block)	p. 166
⑫ AS-Interface Power Supply Cable	p. 166

Made to Order	
① DeviceNet™, 7/8 inch connector, Occupied points: 48 inputs/32 outputs	p. 167
Communication Cable	p. 167
Power Supply Cable	p. 168

Specific Product Precautions	p. 170
------------------------------------	--------

Fieldbus System For Input/Output

EX250 Series



* Only the SY and SV valves are UL-compliant.

Parts Structure

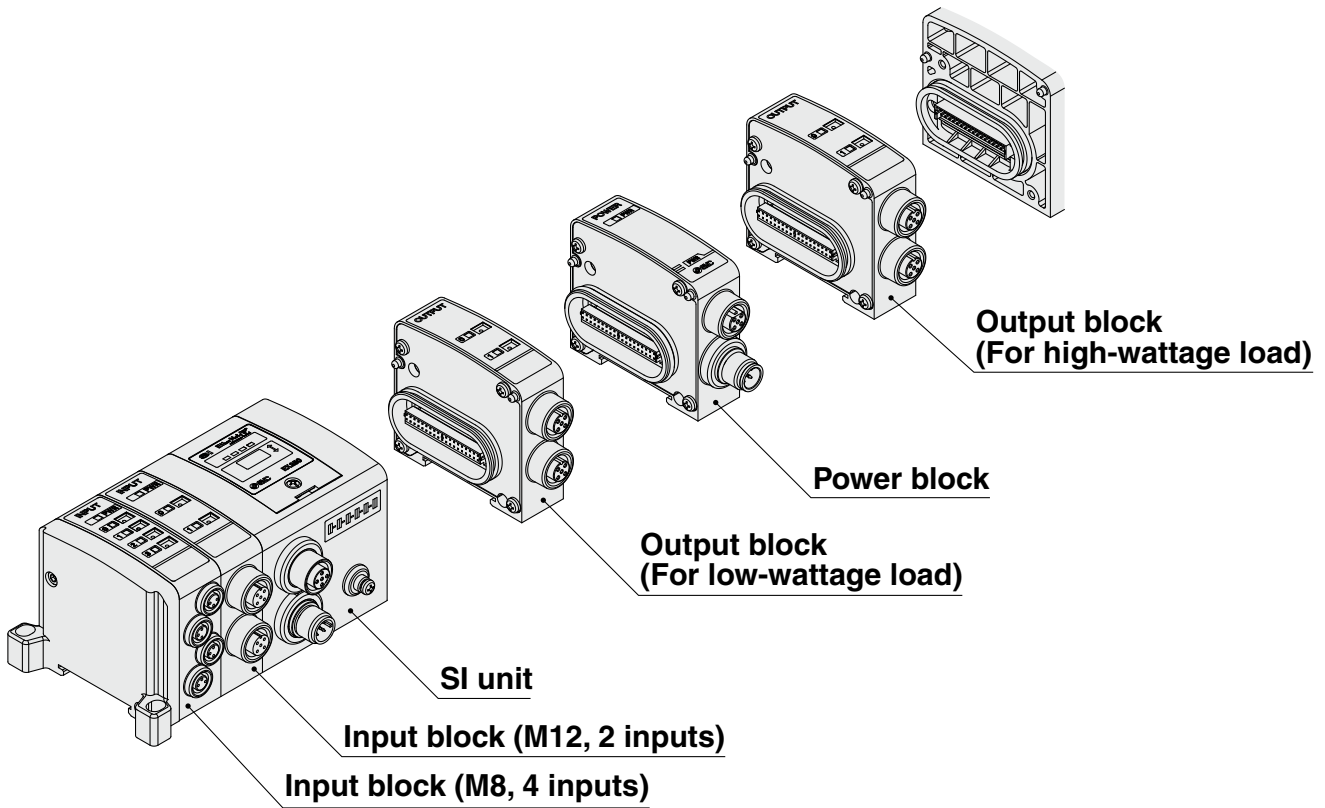

Type 1	EX260
	EX123/124/126
Type 2	EX500
	EX600
Type 3	EX245
	EX250
	EX120/121/122
Type 1	EX140
	EX180
Type 2	EX510
	M8/M12
	ATEX

How to Order

EX250 - S DN1 -

• Made to Order → p. 167
DeviceNet™ 7/8 inch connector

• Protocol

DN1*1	DeviceNet™
DN1-X102*1	DeviceNet™
PR1	PROFIBUS DP
MJ2	CC-Link
AS3	AS-Interface (8in/8out 31 Slave Mode, 2 power supply systems)
AS5	AS-Interface (4in/4out 31 Slave Mode, 2 power supply systems)
AS7	AS-Interface (8in/8out 31 Slave Mode, 1 power supply system)
AS9	AS-Interface (4in/4out 31 Slave Mode, 1 power supply system)
CA1A	CANopen
EN1	EtherNet/IP™

*1 DN1's occupied points are 32 inputs and 32 outputs, while DN1-X102 has 48 inputs and 32 outputs.

SI Unit

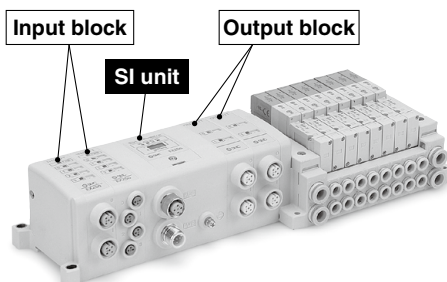
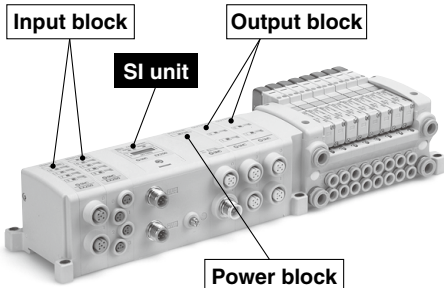

EX250 Series

Specifications

Model		EX250-SDN1	EX250-SDN1-X102 ^{*1}	EX250-SPR1	EX250-SMJ2	EX250-SCA1A	EX250-SEN1	EX250-SAS3/5	EX250-SAS7/9
Communication	Applicable system	DeviceNet™		PROFIBUS DP	CC-Link	CANopen	EtherNet/IP™	AS-Interface	
	Protocol Version ^{*2}	Release 2.0		DP-V0	Ver. 1.10	CIA DS-301 V4.02 CIA DS-401	Release 1.0	Ver. 2.11 (Standard Address Mode)	
	Communication speed	125 k/250 k/500 kbps		9.6 k/19.2 k/ 45.45 k/93.75 k/ 187.5 k/500 k/ 1.5 M/3 M/6 M/ 12 Mbps	156 k/625 k/ 2.5 M/5 M/ 10 Mbps	10 k/20 k/50 k/ 125 k/250 k/ 500 k/800 k/ 1 Mbps	10 M/100 Mbps	167 kbps	
	Configuration file ^{*3}	EDS file		GSD file	CSP+ file	EDS file	EDS file	—	—
	I/O occupation area (Inputs/Outputs)	32/32	48/32	32/32	64/64 (2 stations, remote device station)	32/32	48/32	SAS3: 8/8 (2 slave units) SAS5: 4/4	SAS7: 8/8 (2 slave units) SAS9: 4/4
	Applicable function	QuickConnect™		—	—	—	—	—	—
	Terminating resistor	Not provided						Not provided (Not required)	
Power supply voltage	For control	11 to 25 VDC (Supplied by DeviceNet™ circuit)		24 VDC ±20%		18 V to 30 VDC (Supplied by CANopen circuit)	24 VDC ±20%	26.5 to 31.6 VDC (Supplied by AS-i circuit)	*4 26.5 to 31.6 VDC (Supplied by AS-i circuit)
	For sensors	24 VDC ±20%				24 VDC±20%			
	For valve	24 VDC +10%/−5%							
Internal current consumption (Unit)		100 mA or less						SAS3: 100 mA or less SAS5: 65 mA or less	SAS7: 100 mA or less SAS9: 65 mA or less
Input	Number of inputs	32 inputs (Based on input block connection)						SAS3: 8 inputs SAS5: 4 inputs	SAS7: 8 inputs SAS9: 4 inputs
	Supply voltage	24 VDC							
	Supply current	1.0 A or less						SAS3: 240 mA or less SAS5: 120 mA or less	*5
Output	Output type	Source/PNP (Negative common)			Sink/NPN (Positive common)	Source/PNP (Negative common)			
	Number of outputs	32 outputs						SAS3: 8 outputs SAS5: 4 outputs	SAS7: 8 outputs SAS9: 4 outputs
	Load	Solenoid valve with surge voltage suppressor 24 VDC, 1.5 W or less (SMC) Output block Power block							
	Supply voltage	24 VDC							
	Supply current	2.0 A or less						SAS3: 500 mA or less SAS5: 250 mA or less	*5
	Fail safe	HOLD/CLEAR (Switch setting)		CLEAR	HOLD/CLEAR (Switch setting)				
Environmental resistance	Enclosure	IP67							
	Operating temperature range	5 to +45°C				−10 to +50°C	5 to +45°C		
	Operating humidity range	35 to 85%RH (No condensation)							
	Withstand voltage	500 VAC for 1 minute between whole external terminal and FG							
	Insulation resistance	10 MΩ or more (500 VDC) between whole external terminal and FG							
Standards		CE marking, UL (CSA)							
Weight		250 g							
Accessory ^{*6}		Tie-rod 2 pcs.							

*1 This is a specification to transmit the diagnostic information of voltage drop of the valve power supply and input block fuse blowout as an input data to the master. The EX250-SDN1 becomes I/O connection time out when the diagnostic information is detected, but not EX250-SDN1-X102. Since this is a special product, a manifold part number is not specified. Please consult SMC for the manifold integrated type.

*2 Please note that the version is subject to change.

*3 The setting file can be downloaded from SMC website, <http://www.smcworld.com>

*4 Since the EX250-SAS7/9 is compatible with the 1 power supply system, the power supply for units is divided into two: the power supply for sensors and for valves.

*5 Since the EX250-SAS7/9 is compatible with the 1 power supply system, the power supply must be divided in accordance with the values below. (Refer to page 170 for details.)

EX250-SAS7 ... Max. 240 mA, EX250-SAS9 ... Max. 120 mA

*6 When the SI unit is mounted to the manifold when shipped, accessories are shipped together with it.

*7 For detailed specifications other than the above, refer to the operation manual that can be downloaded from SMC website, <http://www.smcworld.com>

Dimensions/Parts Description

EX250-SDN1 (DeviceNet™)

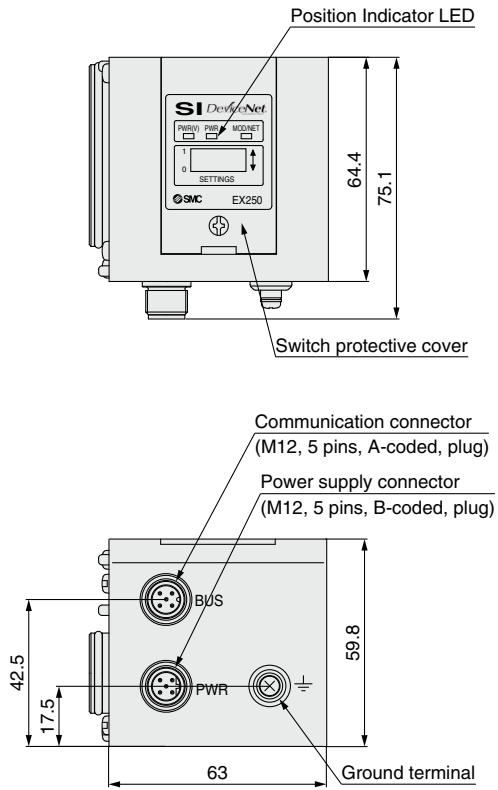

EX250-SPR1 (PROFIBUS DP)

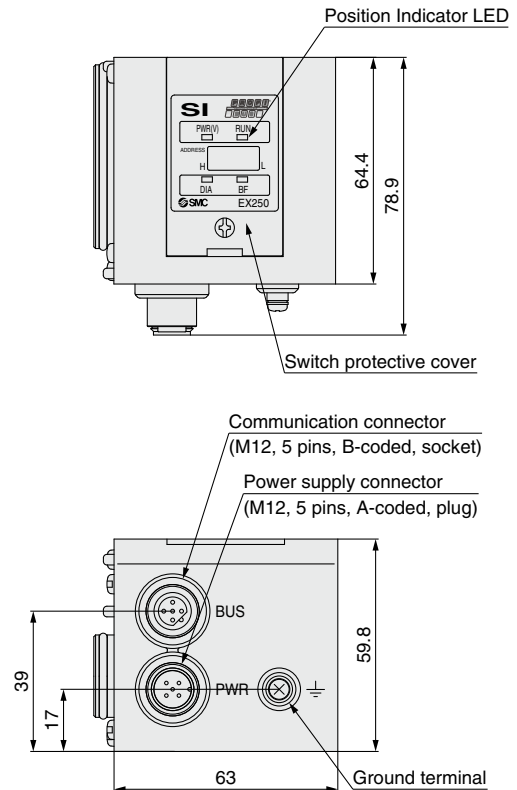

EX250-SMJ2 (CC-Link)

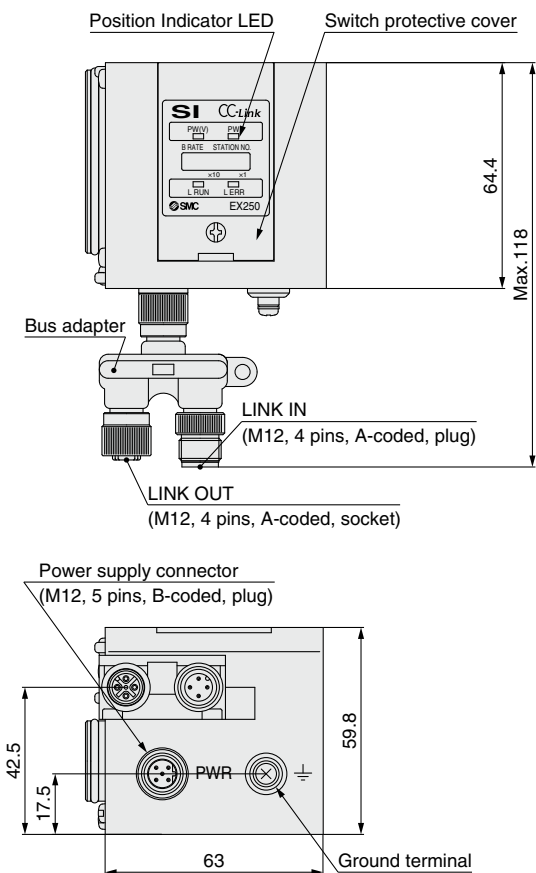

Type 1	EX260
Type 2	EX123/124/126
Type 3	EX500
	EX600
	EX245
	EX250
Type 1	EX120/121/122
	EX140
	EX180
Type 2	EX510
	M8/M12
	ATEX

EX250 Series

Dimensions/Parts Description

EX250-SCA1A (CANopen)

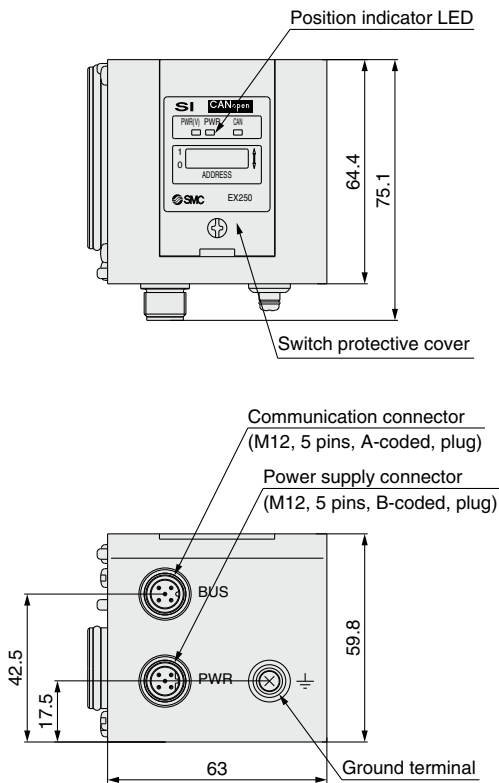

EX250-SEN1 (EtherNet/IP™)

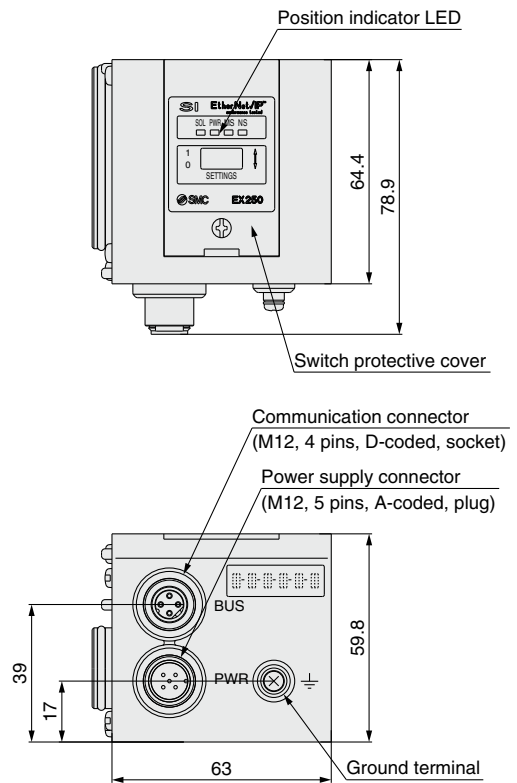

EX250-SAS7/9 (AS-Interface 1 power supply system)

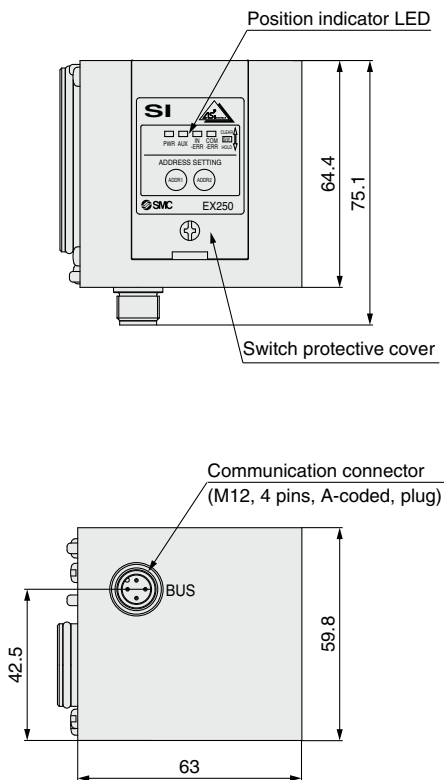

EX250-SAS3/5 (AS-Interface 2 power supply systems)

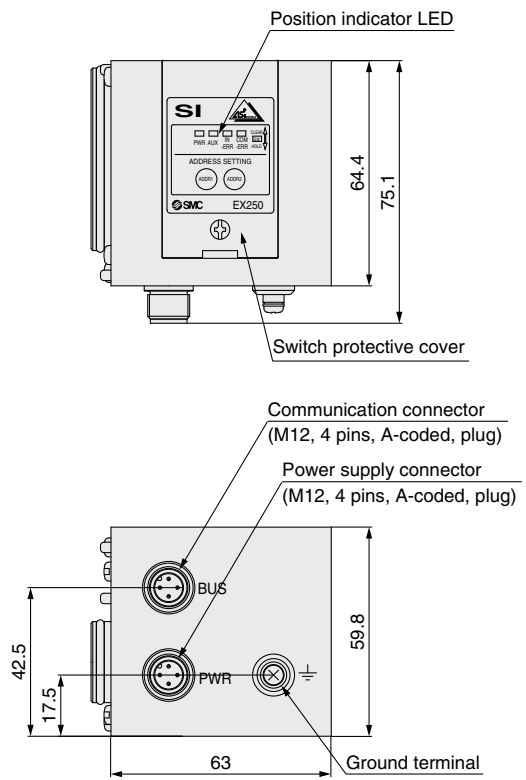

LED Indicator

EX250-SDN1 (DeviceNet™)

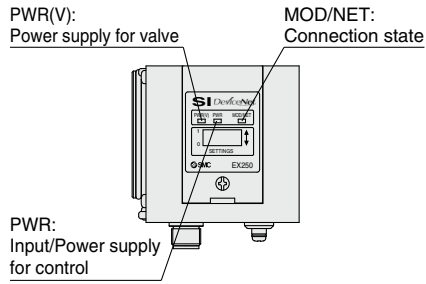

EX250-SPR1 (PROFIBUS DP)

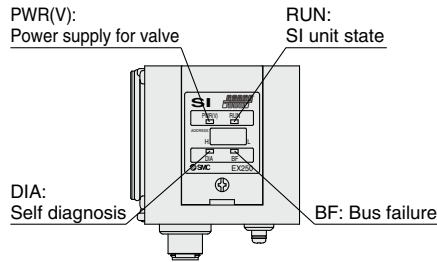

EX250-SMJ2 (CC-Link)

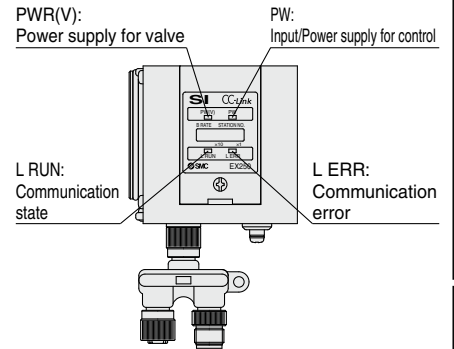

EX250-SCA1A (CANopen)

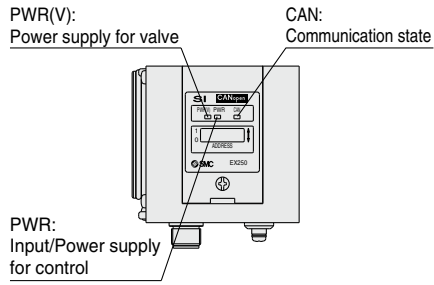

EX250-SEN1 (EtherNet/IP™)

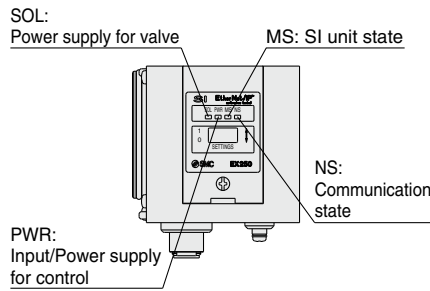

EX250-SAS7/9 (AS-Interface 1 power supply system)

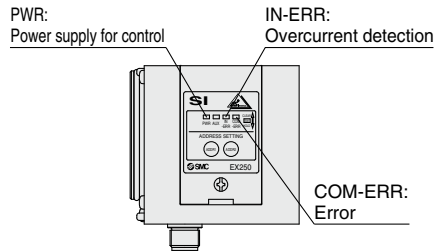

EX250-SAS3/5 (AS-Interface 2 power supply systems)

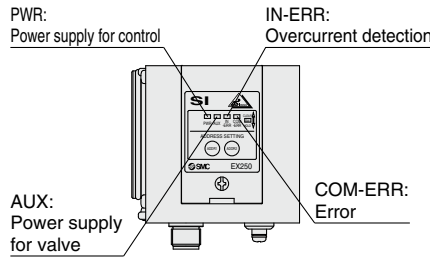

Type 1	EX260
	EX123/124/126
Type 2	EX500
	EX600
Type 3	EX245
	EX250
Type 1	EX120/121/122
	EX140
	EX180
Type 2	EX510
	M8/M12
	ATEX

EX250 Series

How to Order

Input Block

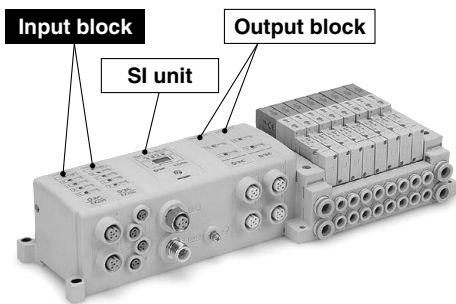
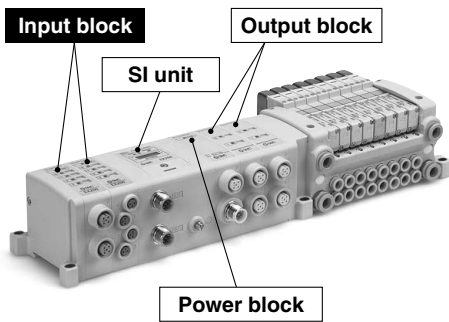

EX250-IE 1

Block type

1	M12 connector, 2 inputs
2	M12 connector, 4 inputs
3	M8 connector, 4 inputs

For accessory, refer to pages 156 to 166.

Specifications

Model		EX250-IE1	EX250-IE2	EX250-IE3
Input	Input type	PNP/NPN sensor input (switched using a switch)		
	Number of inputs	2 inputs	4 inputs	
	Input device supply voltage	24 VDC		
	Input device supply current	Max. 30 mA/Point*1		
	Rated input current	Approx. 8 mA		
Environmental resistance	Enclosure	IP67		
	Operating temperature range	-10 to +50°C		
	Operating humidity range	35 to 85%RH (No condensation)		
	Withstand voltage	500 VAC for 1 minute between whole external terminal and FG		
Insulation resistance	10 MΩ or more (500 VDC) between whole external terminal and FG			
Standards	CE marking, UL (CSA)			
Weight	90 g			
Accessory*2	Tie-rod 2 pcs.			

*1 When the maximum inputs to the SI unit is reached by adding an input block, pay attention not to exceed the supply current for the SI unit input.

*2 When the SI unit is integrated into manifold, its tie-rod is also incorporated at the time of shipment.

* For detailed specifications other than the above, refer to the operation manual that can be downloaded from SMC website, <http://www.smcworld.com>

Dimensions/Parts Description

EX250-IE1, EX250-IE2

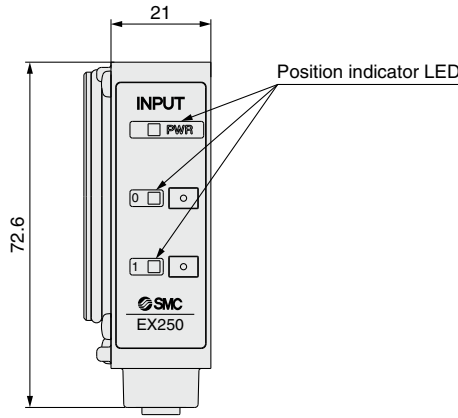
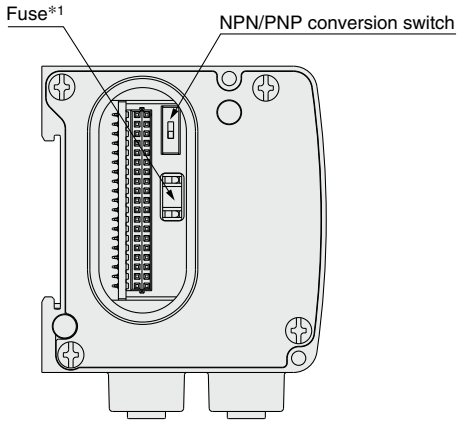

EX250-IE1

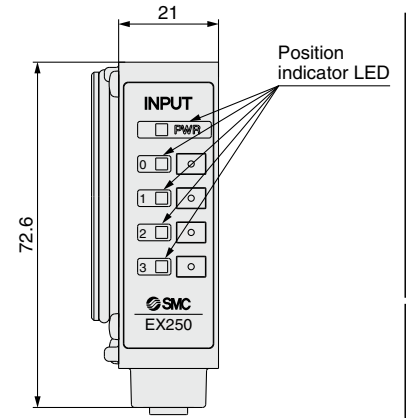

EX250-IE2

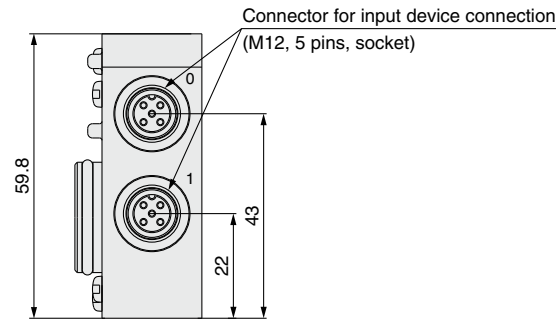
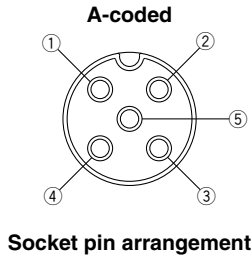

EX250-IE3

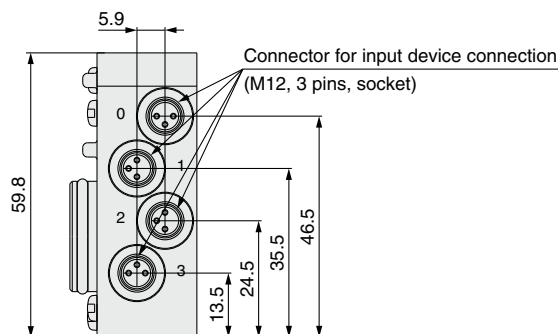
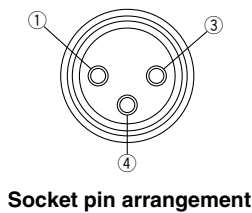
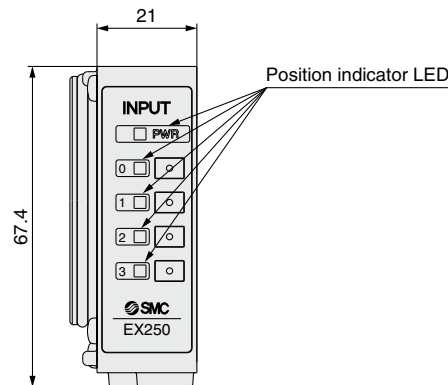
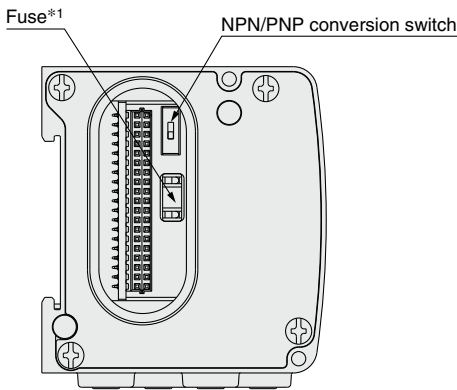

*1 Fuse for overcurrent protection
If addressing the possible cause of a problem, even when the fuse is blown, it can be reinstated by replacing with a fuse as shown in options, page 157

Type 1	EX260
Type 1	EX123/124/126
Type 2	EX500
Type 2	EX600
Type 2	EX245
Type 2	EX250
Type 3	EX120/121/122
Type 3	EX140
Type 3	EX180
Type 3	EX510
Type 3	M8/M12
Type 3	ATEX

EX250 Series

LED Indicator

EX250-IE1

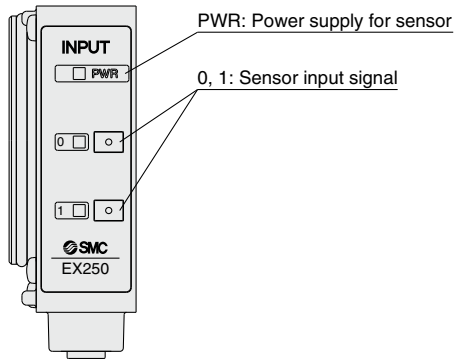

EX250-IE2

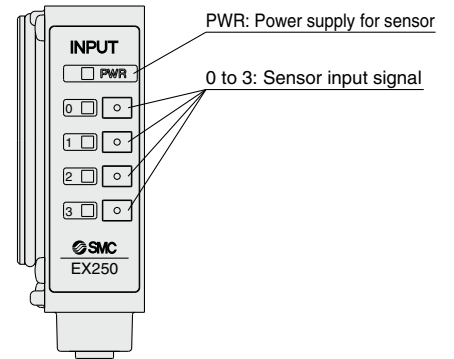

EX250-IE3

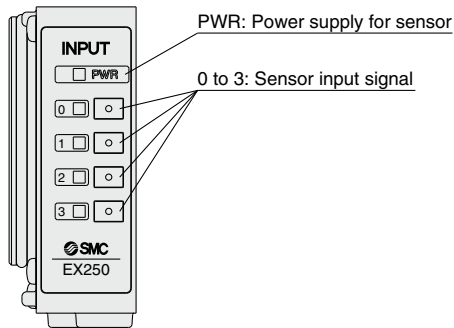

Internal Circuit

EX250-IE1

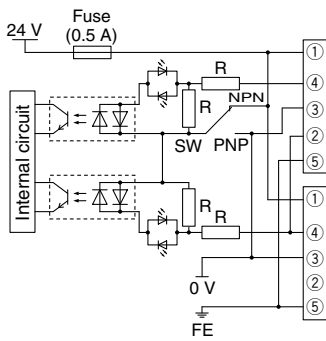

EX250-IE2

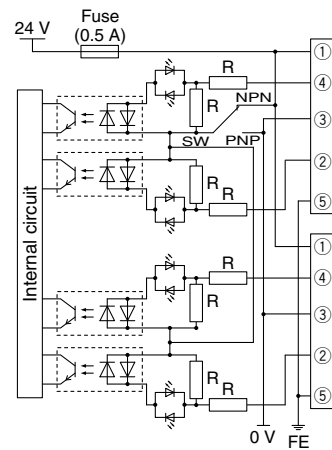

EX250-IE3

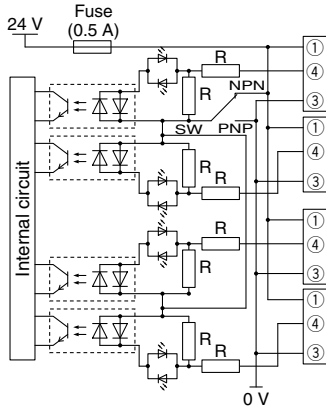

EX250 Series Accessories

Example of Connections

Connection example of an SI unit compatible with DeviceNet™, CANopen, CC-Link

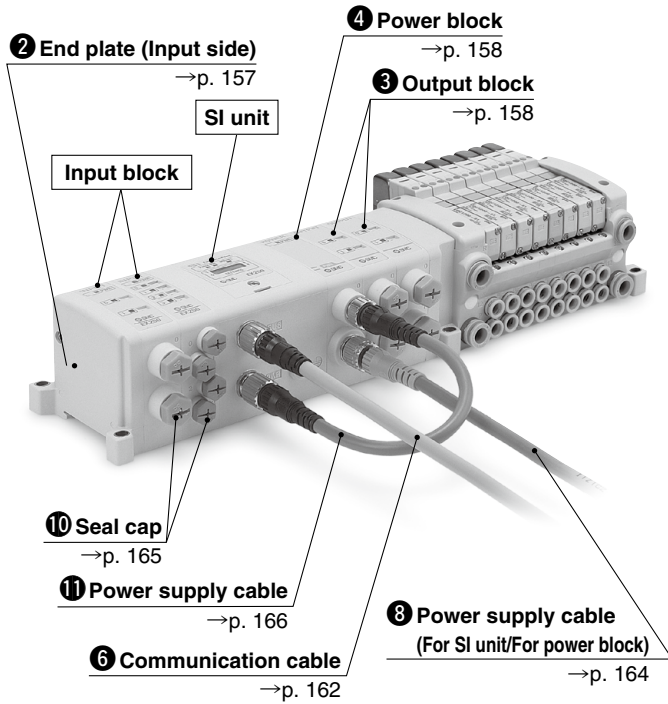

* The SI unit pictured above is compatible with DeviceNet™.

Connection example of an SI unit compatible with EtherNet/IP™, PROFIBUS DP

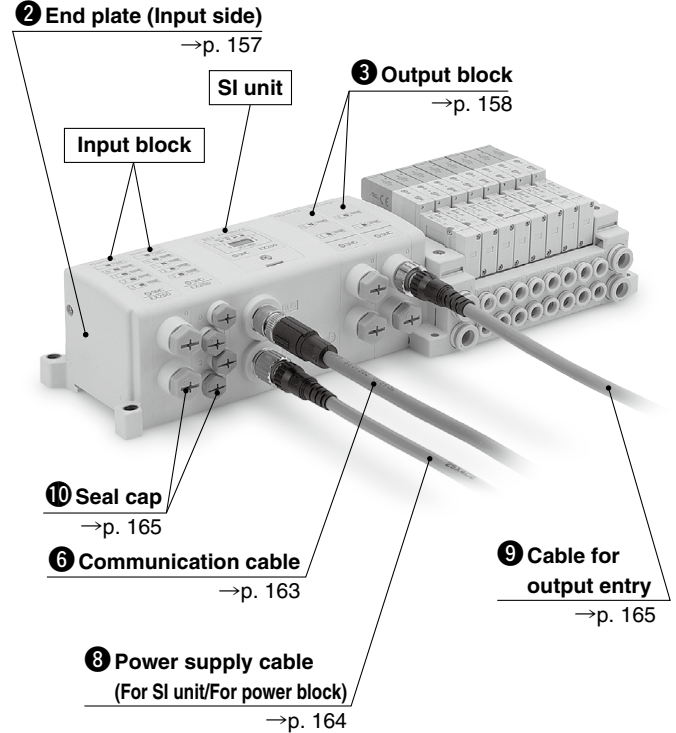

* The SI unit pictured above is compatible with PROFIBUS DP.

Connection example of an SI unit compatible with AS-Interface

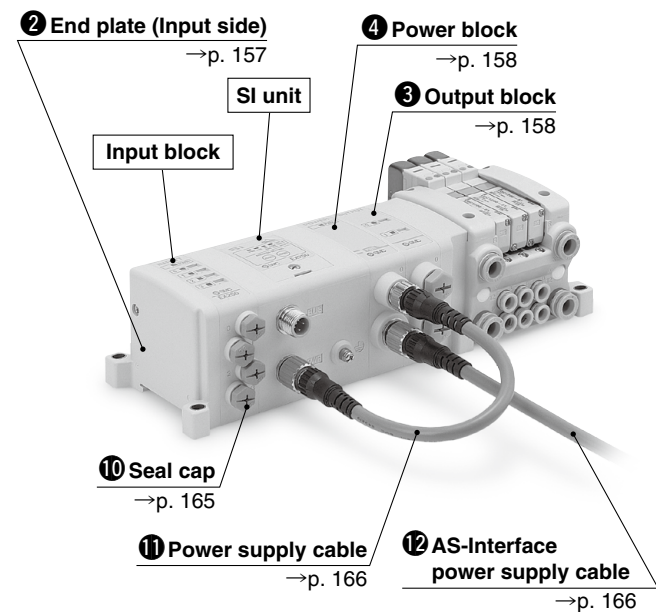

Type 1	EX260
	EX123/124/126
Type 2	EX500
	EX600
Type 3	EX245
	EX250
Type 1	EX120/121/122
	EX140
	EX180
Type 2	EX510
	M8/M12
	ATEX

EX250 Series

① Replacement Fuse

Replacement fuse required when the fuse for the input block (EX250-IE□) overcurrent protection is blown.

EX9-FU05

Model	EX9-FU05
Applicable model	EX250-IE□
Rated current	0.5 A
Rated insulation capacity	48 VAC/DC 50 A
Fuse resistance value	0.36 Ω

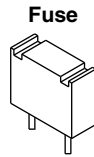

② End Plate (Input side)

EX250-EA 1

● Mounting specification

1	Direct mounting
2	DIN rail mounting

Accessory
Hexagon socket head cap screw (M3 x 10): 2 pcs.

<Example of use>

End plate (Input side)



EX250-EA1

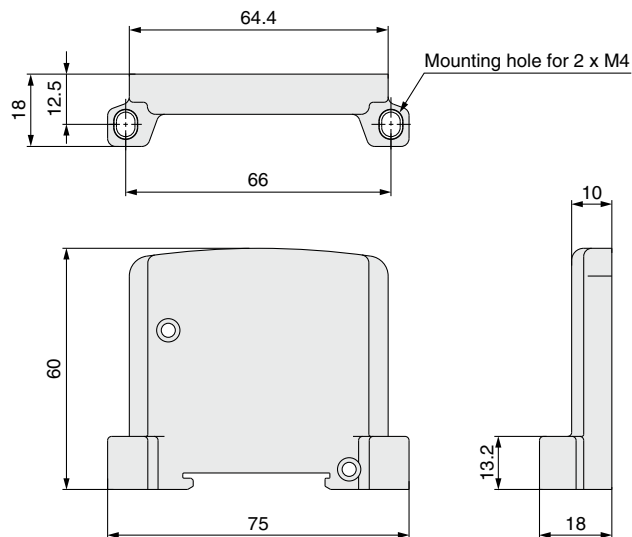

EX250-EA2

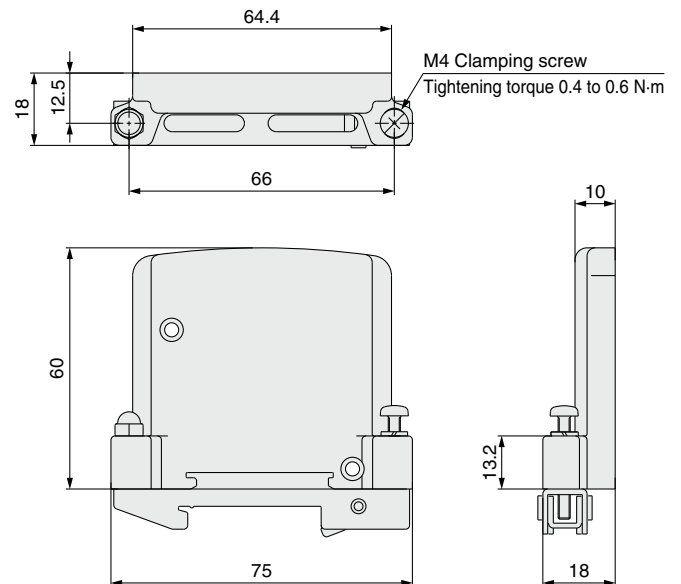

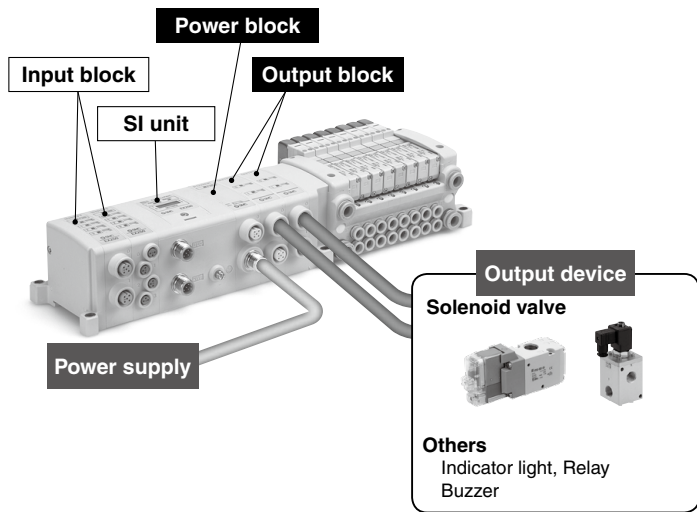

- Able to retrofit to the valve manifold, using the unused points
- 2-output (M12 connector)
- Positive/Negative common available as standard
- Able to drive by 0.5 A per point

You are requested to connect it to an SI unit and a valve manifold. For detailed specifications, refer to the operation manual that can be downloaded from SMC website, <http://www.smcworld.com>

3 Output Block

EX9-OE T 1

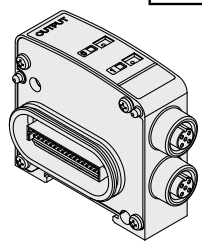

• Output specification

1	Source/PNP (Negative common)
2	Sink/NPN (Positive common)

• Power supply type

T	Internal power supply method (for low-wattage load)
P	Integrated power supply method (for high-wattage load)*1

*1 Required to connect with a power block

SI Unit/Part Nos.

SI unit part no.	Output	Applicable model
EX250-SDN1 EX250-SPR1 EX250-SAS□ EX250-SCA1A EX250-SEN1	Source/PNP (Negative common)	EX9-OET1 EX9-OEP1
EX250-SMJ2	Sink/NPN (Positive common)	EX9-OET2 EX9-OEP2

Option/Part Nos.

Description	Part no.	Applicable model		Note
		OET□	OEP□	
Seal cap	EX9-AWTS	○	○	Refer to page 165. Order separately: 10 pcs. included
Cable for output entry	EX9-AC□-7	○	○	Refer to page 165. Order separately.
Power block	EX9-PE1		○	Refer to page 159. Order separately.

4 Power Block

EX9-PE1

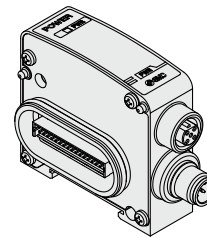

Option/Part Nos.

Description	Part no.	Note
Seal cap	EX9-AWTS	Refer to page 165. Order separately: 10 pcs. included
Power supply cable (For SI unit/For power block)	EX9-AC□-1	Refer to page 164. Order separately.
Power supply cable (For connecting the SI unit to the power block)	EX9-AC002-2 EX9-AC002-3 EX9-AC002-4	Refer to page 166. Order separately.
AS-Interface power supply cable	EX9-AC□-5	Refer to page 166. Order separately.

Type 1
EX260
EX123/124/126

Type 2
EX500

Type 3
EX600

EX245

EX250

Type 1
EX120/121/122

EX140

EX180

Type 2
EX510

M8/M12

ATEX

EX250 Series

③ Output Block/④ Power Block

Output Block Specifications

Model		EX9-OET1	EX9-OET2	EX9-OEP1	EX9-OEP2
Output connector		M12 connector (5 pins)			
Internal current consumption		40 mA or less			
Output	Output type	Source/PNP (Negative common)	Sink/NPN (Positive common)	Source/PNP (Negative common)	Sink/NPN (Positive common)
	Number of outputs	2 outputs			
	Power supply method	Internal power supply method		Integrated power supply method (Power block: supplied from EX9-PE1)	
	Output device supply voltage	24 VDC			
	Output device supply current	Max. 62 mA/Point (1.5 W/Point)		Max. 0.5 A/Point (12 W/Point)	
Environmental resistance	Enclosure	IP67			
	Operating temperature range	-10 to +50°C			
	Operating humidity range	35 to 85%RH (No condensation)			
	Withstand voltage	1500 VAC for 1 minute between whole external terminal and FG			
	Insulation resistance	10 MΩ or more (500 VDC) between whole external terminal and FG			
Standards		CE marking, UL (CSA)			
Weight		120 g			
Accessory	Tie-rod	2 pcs.			

Power Block Specifications

Model		EX9-PE1
Connection block		Output block (EX9-OEP□)
Connection block stations		Output block: Max. 9 stations (excluding input blocks)*1
Power supply for output and internal control	Power supply voltage	22.8 to 26.4 VDC
	Internal power consumption	20 mA or less
Supply current		Max. 3.1 A (When using with 3.0 to 3.1 A, the ambient temperature should not exceed 40°C, and do not bundle the cable.)
Environmental resistance	Enclosure	IP67
	Operating temperature range	-10 to +50°C
	Operating humidity range	35 to 85%RH (No condensation)
	Withstand voltage	1500 VAC for 1 minute between whole external terminal and FG
	Insulation resistance	10 MΩ or more (500 VDC) between whole external terminal and FG
Standards		CE marking, UL (CSA)
Weight		120 g
Accessory	Tie-rod	2 pcs.
	Seal cap (for M12 connector socket)	1 pc. (EX9-AWTS)

*1 The total number of connectable input/output/power block to the EX250 series SI unit (except for AS-Interface compliant) is 10 stations at the maximum.

* For detailed specifications other than the above, refer to the operation manual that can be downloaded from SMC website, <http://www.smcworld.com>

Output Block Dimensions/Parts Description

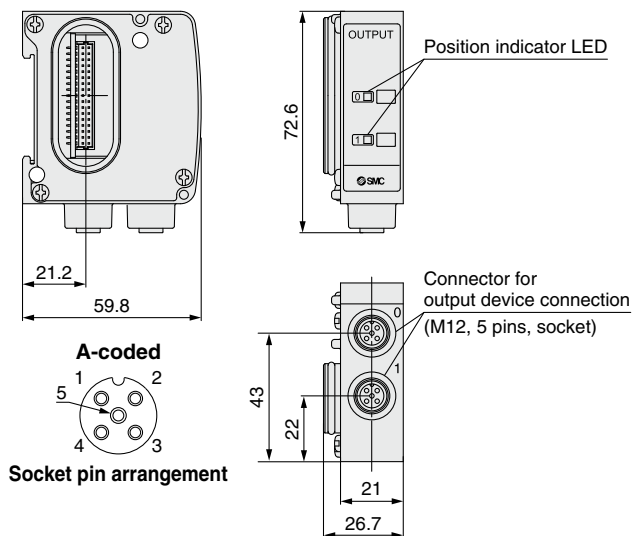

Power Block Dimensions/Parts Description

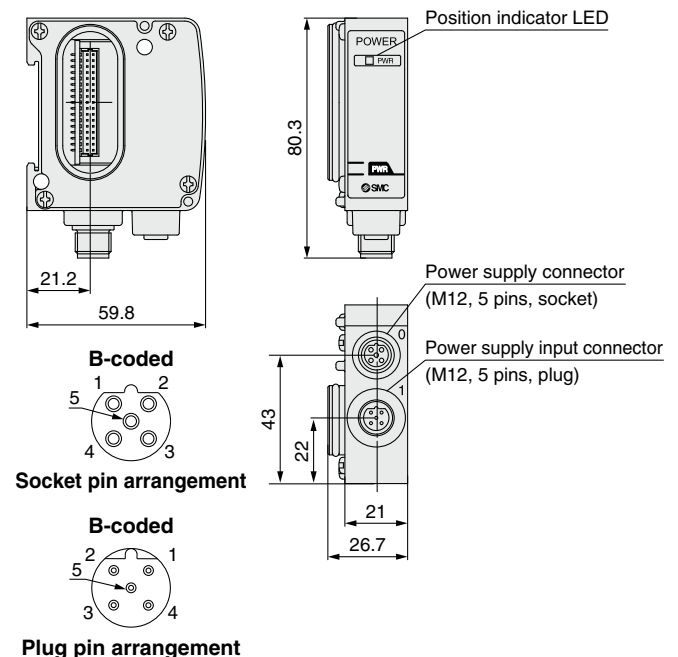

③ Output Block/④ Power Block

Circuit Diagram

EX9-OET1

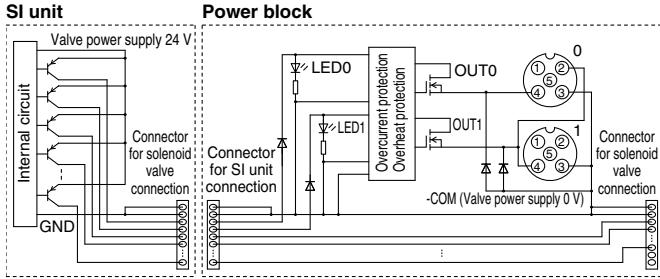

EX9-OET2

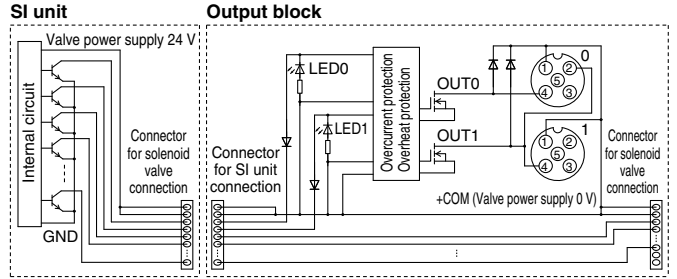

EX9-OEP1

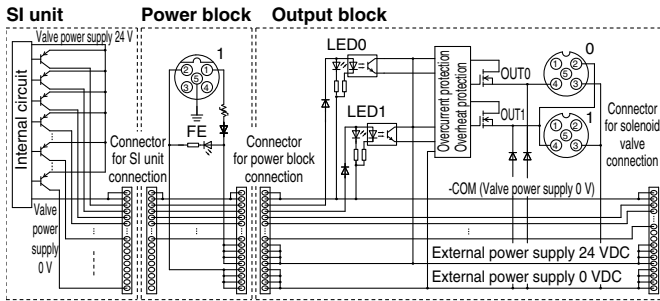

EX9-OEP2

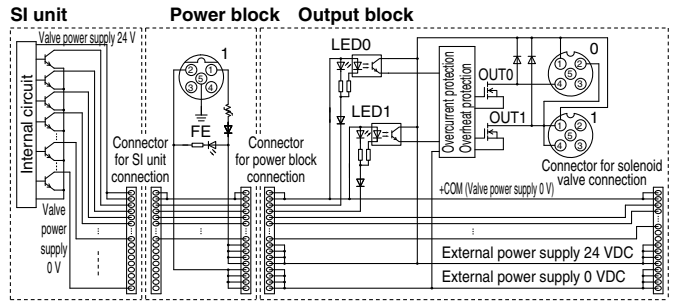

EX9-PE1

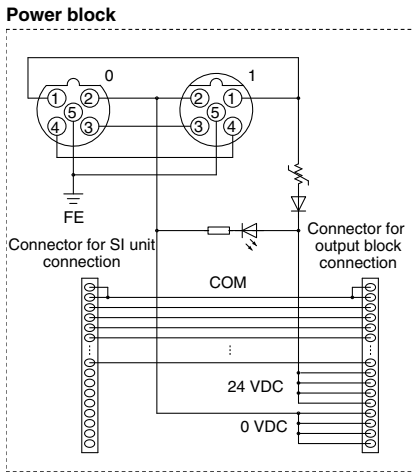

* When the valve which supplies power to the SI unit is turned OFF, the output of the output block (EX9-OE□) remains OFF.

Type 1	EX260
	EX123/124/126
Type 2	EX500
	EX600
Type 3	EX245
	EX250
Type 1	EX120/121/122
	EX140
	EX180
Type 2	EX510
	M8/M12
	ATEX

EX250 Series

⑤ End Plate (Output side)

Use the end plate when a valve manifold is not connected.

EX9-EA 03

● **Mounting specification**

03	Direct mounting
04	DIN rail mounting

<Example of use>

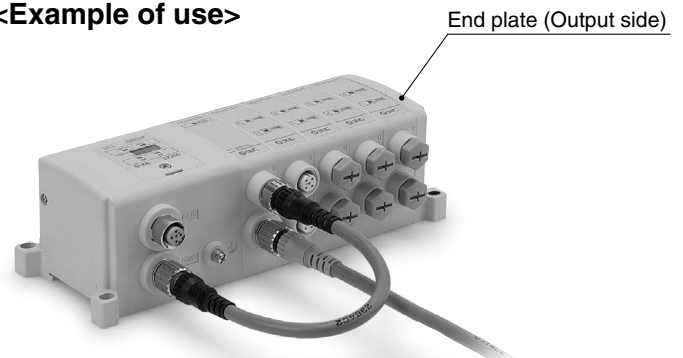

EX9-EA03

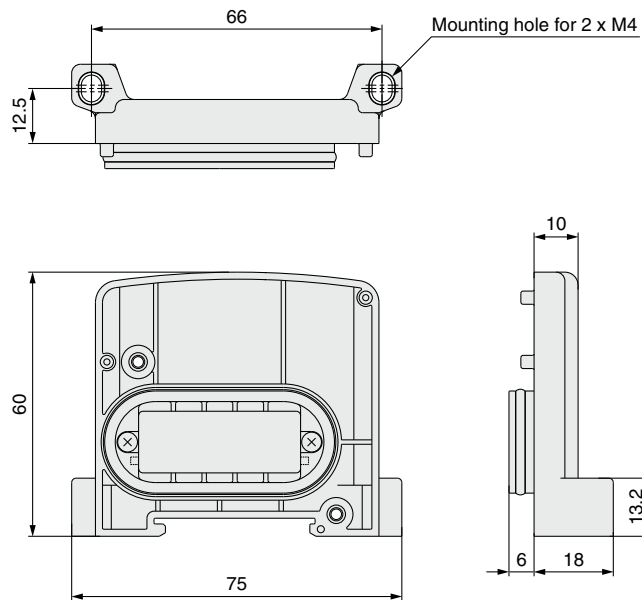

EX9-EA04

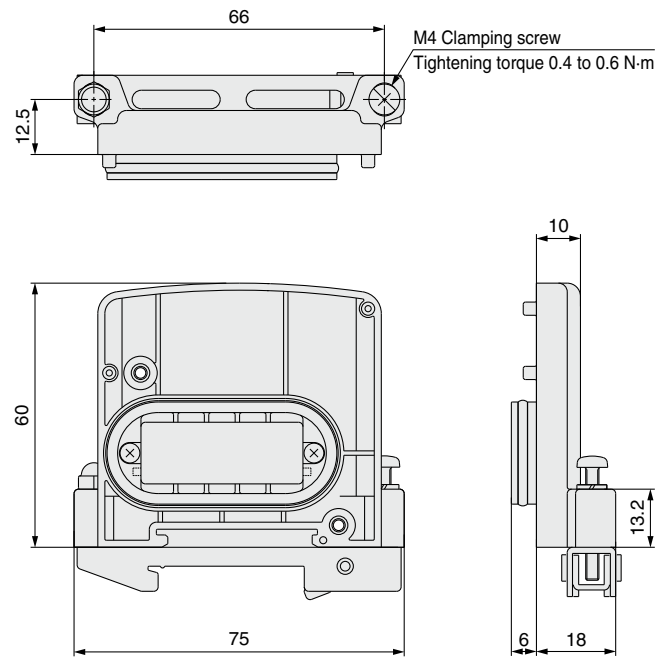

6 Communication Cable

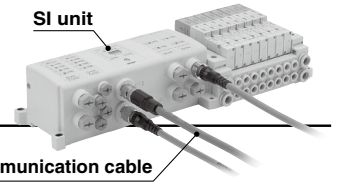

For CC-Link

PCA-1567720
(Socket)

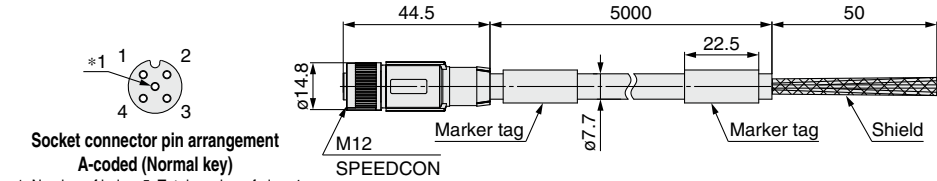

Socket connector pin arrangement
A-coded (Normal key)

*1 Number of holes: 5, Total number of pins: 4

PCA-1567717
(Plug)

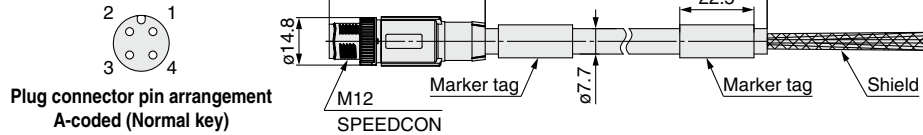

Plug connector pin arrangement
A-coded (Normal key)



Made to Order

Cable length	10000 mm	p. 167
--------------	----------	--------

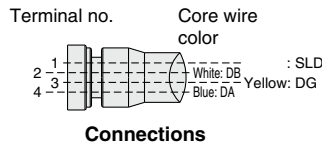

Connections

Item		Specifications
Cable O.D.		ø7.7 mm
Conductor nominal cross section	Data pair	0.5 mm ² /AWG20
	Drain	0.34 mm ² /AWG20
Wire O.D. (Including insulator)		2.55 mm
Min. bending radius (Fixed)		77 mm

EX9-AC 005 MJ-SSPS (With connector on both sides (Socket/Plug))

Cable length (L)

005	500 mm
010	1000 mm
020	2000 mm
030	3000 mm
050	5000 mm
100	10000 mm

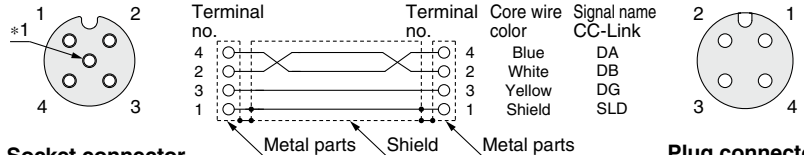
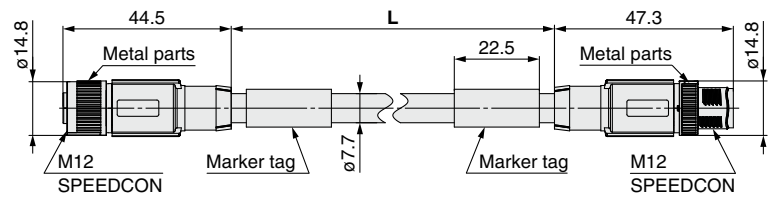

Socket connector pin arrangement
A-coded (Normal key)

*1 Number of holes: 5,
Total number of pins: 4

Connections

Plug connector pin arrangement
A-coded (Normal key)

Item		Specifications
Cable O.D.		ø7.7 mm
Conductor nominal cross section	Data pair	0.5 mm ² /AWG20
	Drain	0.34 mm ² /AWG22
Wire O.D. (Including insulator)		2.55 mm
Min. bending radius (Fixed)		77 mm

Type 1	EX260
	EX123/124/126
Type 2	EX500
	EX600
Type 3	EX245
	EX250
Type 1	EX140
	EX120/121/122
Type 2	EX510
	M8/M12
	ATEX

EX250 Series

⑥ Communication Cable

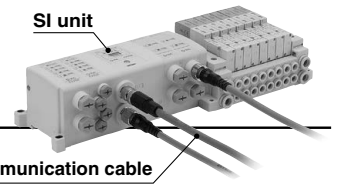

For DeviceNet™ For CANopen

EX500-AC **050** -DN

• Cable length (L)

010	1000 mm
050	5000 mm

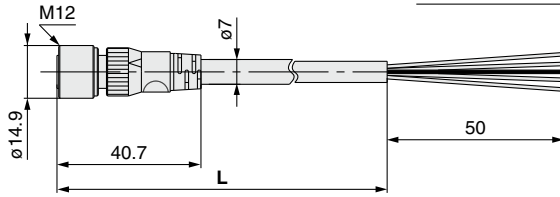

A-coded

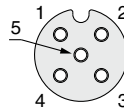

Socket connector pin arrangement

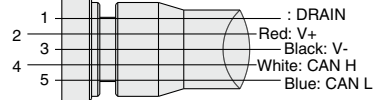

Connections

Item	Specifications
Cable O.D.	ø7 mm
Conductor nominal cross section	Power pair 0.3 mm ² /AWG22
	Data pair 0.2 mm ² /AWG24
Wire O.D. (Including insulator)	Power pair 1.5 mm
	Data pair 1.9 mm
Min. bending radius (Fixed)	60 mm

PCA-1557633
(Socket)

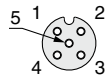

Socket connector pin arrangement
A-coded (Normal key)

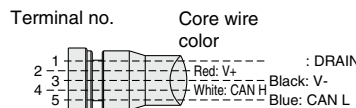
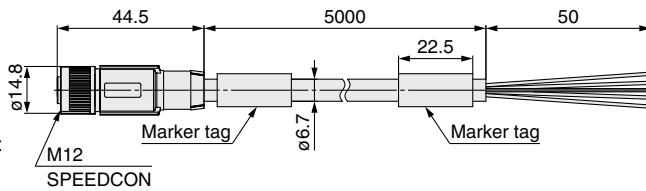

Connections

Item	Specifications
Cable O.D.	ø6.7 mm
Conductor nominal cross section	Power pair 0.34 mm ² /AWG22
	Data pair 0.25 mm ² /AWG24
Wire O.D. (Including insulator)	Power pair 1.4 mm
	Data pair 2.05 mm
Min. bending radius (Fixed)	67 mm



Made to Order

Cable length	10000 mm	p. 167
--------------	----------	--------

EX9-AC **005** DN-SSPS (With connector on both sides (Socket/Plug))

• Cable length (L)

005	500 mm
010	1000 mm
020	2000 mm
030	3000 mm
050	5000 mm
100	10000 mm

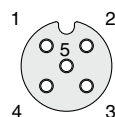
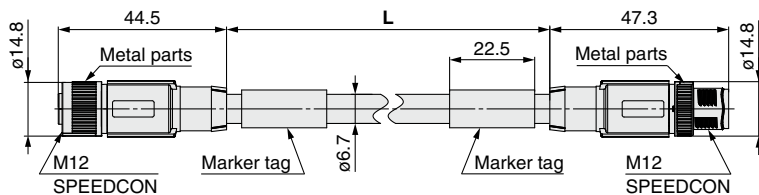

Socket connector pin arrangement
A-coded (Normal key)

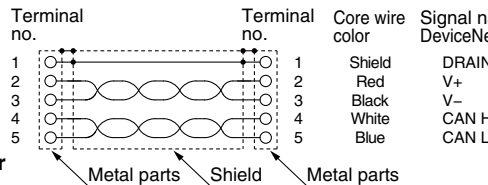

Connections

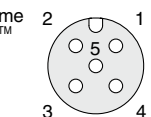

Plug connector pin arrangement
A-coded (Normal key)

Item	Specifications
Cable O.D.	ø6.7 mm
Conductor nominal cross section	Power pair 0.34 mm ² /AWG22
	Data pair 0.25 mm ² /AWG24
Wire O.D. (Including insulator)	Power pair 1.4 mm
	Data pair 2.05 mm
Min. bending radius (Fixed)	67 mm

EX250 Series

⑥ Communication Cable

For PROFIBUS DP

PCA-1557691
(Plug)

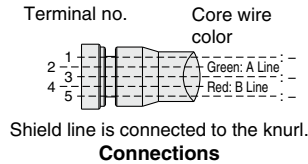
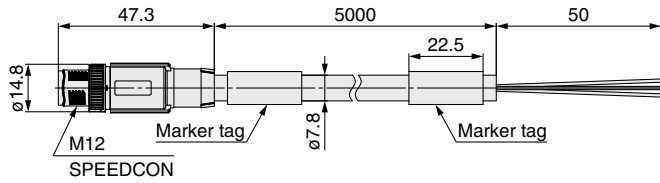
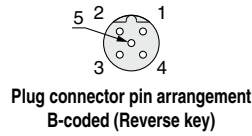

Item	Specifications
Cable O.D.	ø7.8 mm
Conductor nominal cross section	0.34 mm ² /AWG22
Wire O.D. (Including insulator)	2.55 mm
Min. bending radius (Fixed)	78 mm

For EtherNet/IP™

EX9-AC 020 EN-PSRJ (Plug/RJ-45 connector)

● Cable length (L)

010	1000 mm
020	2000 mm
030	3000 mm
050	5000 mm
100	10000 mm



Plug connector
pin arrangement
D-coded

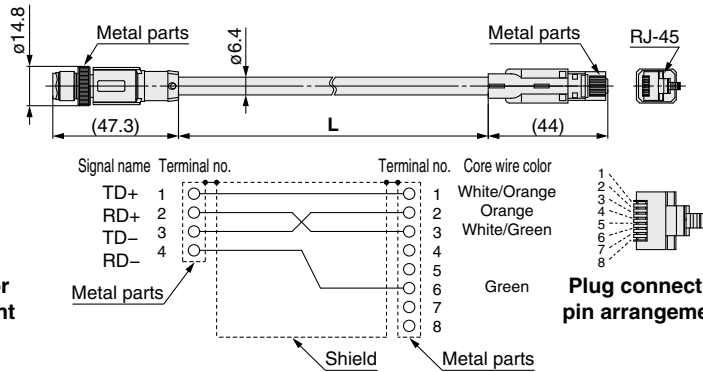

Connections (Straight cable)

Item	Specifications
Cable O.D.	ø6.4 mm
Conductor nominal cross section	0.14 mm ² /AWG26
Wire O.D. (Including insulator)	0.98 mm
Min. bending radius (Fixed)	26 mm

EX9-AC 005 EN-PSPS (With connector on both sides (Plug/Plug))

● Cable length (L)

005	500 mm
010	1000 mm
020	2000 mm
030	3000 mm
050	5000 mm
100	10000 mm

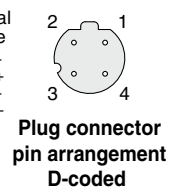
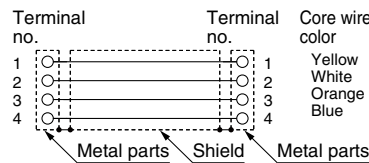
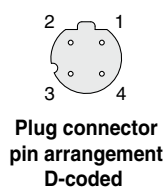
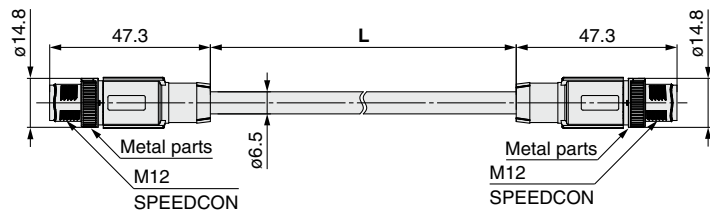

Connections (Straight cable)

Item	Specifications
Cable O.D.	ø6.5 mm
Conductor nominal cross section	0.34 mm ² /AWG22
Wire O.D. (Including insulator)	1.55 mm
Min. bending radius (Fixed)	19.5 mm

7 Field-wireable Communication Connector

Plug

For CC-Link
PCA-1557617

For DeviceNet™
For CANopen
PCA-1557659

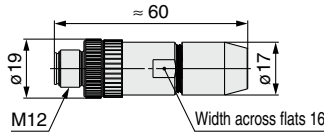

For PROFIBUS DP
PCA-1557701

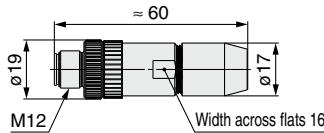

Applicable Cable

Item	Specifications
Cable O.D.	4.0 to 8.0 mm
Wire gauge (Stranded wire cross section)	0.14 to 0.5 mm ² AWG26 to 20

Socket

For CC-Link
PCA-1557620

For DeviceNet™
For CANopen
PCA-1557662

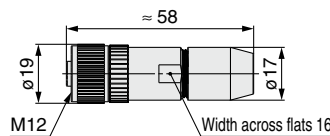

For PROFIBUS DP
PCA-1557714

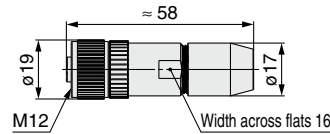

Applicable Cable

Item	Specifications
Cable O.D.	4.0 to 8.0 mm
Wire gauge (Stranded wire cross section)	0.14 to 0.5 mm ² AWG26 to 20

8 Power Supply Cable (For SI unit/For power block)

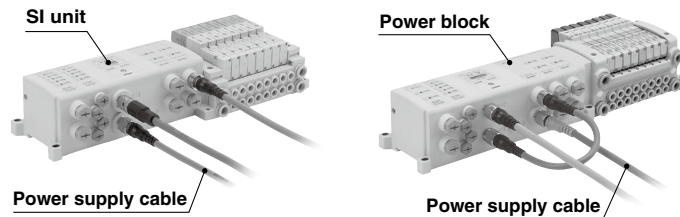

For DeviceNet™ For CC-Link For CANopen For Power block

Straight connector type

EX9-AC 050 -1

• Cable length (L)

010	1000 mm
030	3000 mm
050	5000 mm

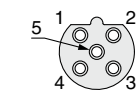

Socket connector
pin arrangement
B-coded

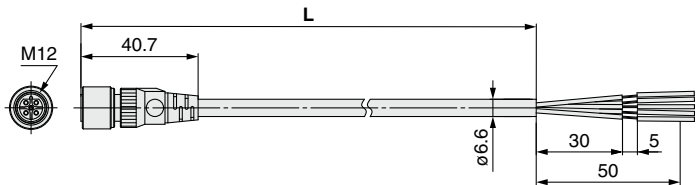

Item	Specifications
Cable O.D.	ø6.6 mm
Conductor nominal cross section	AWG22
Wire O.D. (Including insulator)	1.65 mm
Min. bending radius (Fixed)	40 mm



Made to Order

Cable length	10000 mm	p. 168
--------------	----------	--------

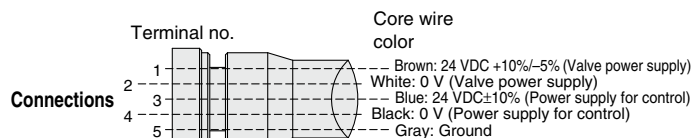

Type 1
EX260
EX123/124/126
EX500
EX600
EX600
EX245
EX250
EX120/121/122
EX140
EX180
EX510
M8/M12
ATEX

EX250 Series

⑧ Power Supply Cable (For SI unit)

For PROFIBUS DP For EtherNet/IP™

EX500-AP **050** -S

Cable length (L)

010	1000 mm
050	5000 mm

Connector specification

S	Straight
---	----------

Straight connector type

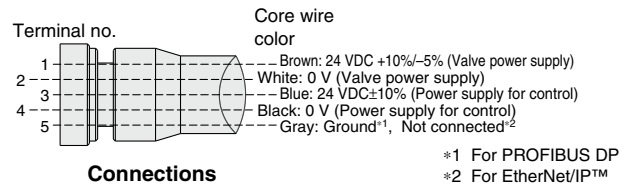
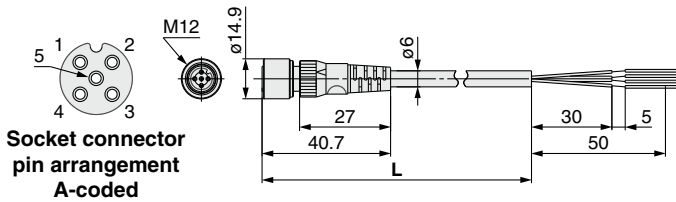

Made to Order

Cable length	10000 mm	p. 169
--------------	----------	--------

Item	Specifications
Cable O.D.	ø6 mm
Conductor nominal cross section	0.3 mm ² /AWG22
Wire O.D. (Including insulator)	1.5 mm
Min. bending radius (Fixed)	40 mm

⑨ Cable for Output Entry

Connects the output block to the output device

EX9-AC **030** -7

Cable length (L)

010	1000 mm
030	3000 mm

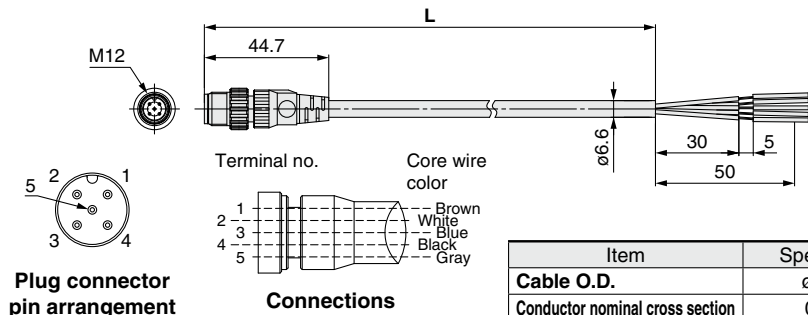
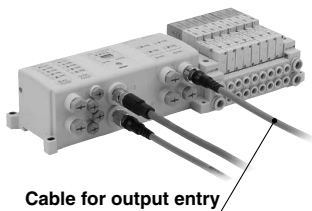

Item	Specifications
Cable O.D.	ø6.6 mm
Conductor nominal cross section	0.3 mm ²
Wire O.D. (Including insulator)	1.65 mm
Min. bending radius (Fixed)	40 mm

⑩ Seal Cap (10 pcs.)

Use this on ports that are not being used for an M8 or M12 connector (socket). Use of this seal cap maintains the integrity of the enclosure. (Seal caps are packed together with each unit.)

* Tighten the seal caps with the prescribed tightening torque. (For M8: 0.05 N·m, For M12: 0.1 N·m)

EX9-AW **ES**

Connector type

ES	M8 connector (For socket), 10 pcs.
TS	M12 connector (For socket), 10 pcs.

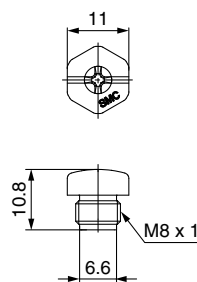
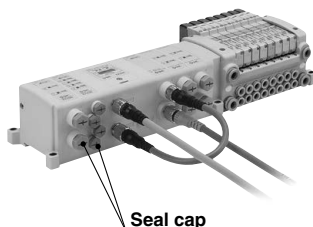

For M8 connector socket

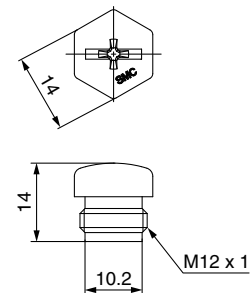

For M12 connector socket

① Power Supply Cable (For connecting the SI unit to the power block)

Connects between the power supply connector for the power block and the SI unit power supply connector, bridging the external power supply, which is supplied with the power block, to the SI unit.

EX9-AC002-2

SI unit type

2	EX250-SDN1 EX250-SMJ2 EX250-SCA1A	Compliant
3	EX250-SPR1 EX250-SEN1	Compliant
4	EX250-SAS3/5	Compliant

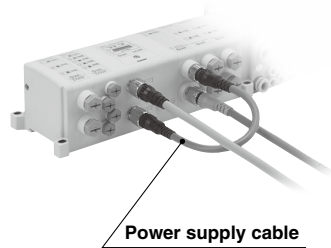

EX9-AC002-2

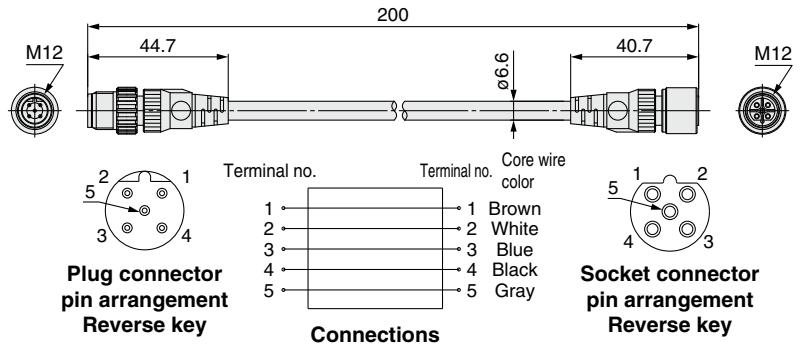

EX9-AC002-3

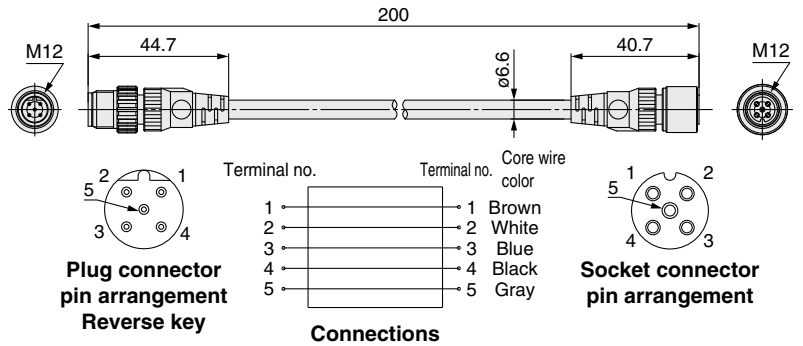

EX9-AC002-4

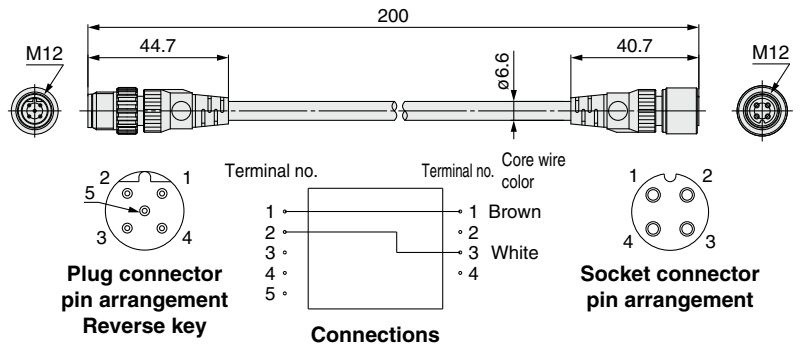

Item	Specifications
Cable O.D.	$\phi 6.6$ mm
Conductor nominal cross section	0.3 mm ²
Wire O.D. (Including insulator)	1.65 mm
Min. bending radius (Fixed)	40 mm

② AS-Interface Power Supply Cable

Cable connecting between AS-Interface power supply line (for external devices) branch connector (M12) and the power block's power supply input connector.

EX9-AC 010 -5

Cable length (L)

010	1000 mm
030	3000 mm
050	5000 mm

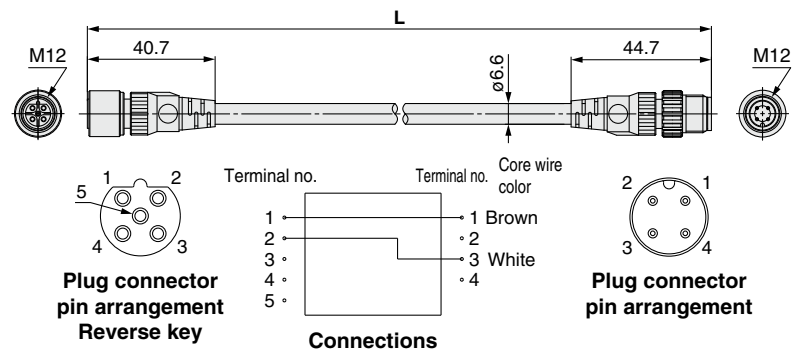
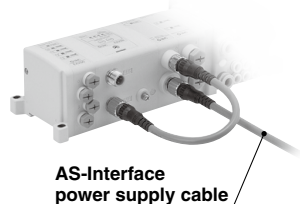

Item	Specifications
Cable O.D.	$\phi 6.6$ mm
Conductor nominal cross section	0.3 mm ²
Wire O.D. (Including insulator)	1.65 mm
Min. bending radius (Fixed)	40 mm

Type 1	EX260
Type 1	EX123/124/126
Type 2	EX500
Type 2	EX600
Type 2	EX600
Type 3	EX245
Type 3	EX250
Type 1	EX120/121/122
Type 1	EX140
Type 1	EX180
Type 2	EX510
Type 2	M8/M12
Type 2	ATEX

EX250 Series Made to Order

Please contact SMC for detailed specifications and lead times.

SI Unit

Prepare the SI unit, each type of block, and the manifold valve (without SI unit) separately, and combine them before use.

- ① **DeviceNet™, 7/8 inch connector,**
32 inputs/32 outputs
(Occupied points: 48 inputs (32 inputs + diagnostic 16 inputs)/32 outputs)

EX250-SDN1-X122

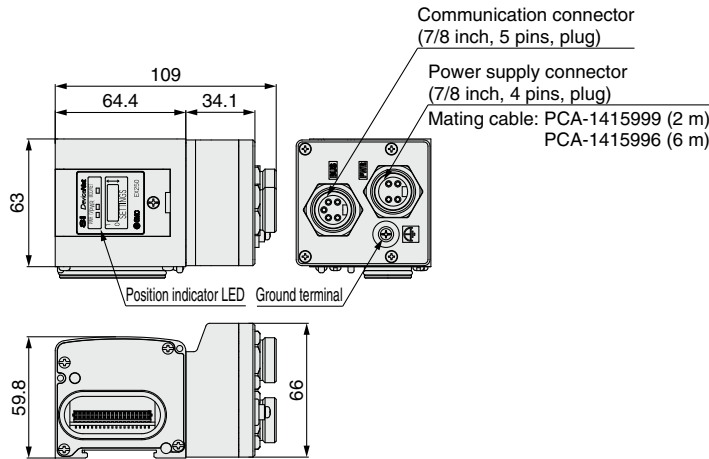

Power supply connector

1	24 VDC +10%/-5% (For valve)
2	Unused
3	FE
4	0 VDC (For valve)

Communication connector

1	DRAIN
2	V+
3	V-
4	CAN H
5	CAN L

* When connecting to a VQC4000 series model, use a VVQC4000-3A-3□, etc., D side end plate. The VVQC4000-3A-2□ D side end plate used by the standard EX250-SDN1 model cannot be used as it will come into contact with the EX250-SDN1-X122.

Communication Cable

- ① **With connector on one side (Socket)**
Cable length: 10000 mm

For CC-Link **For DeviceNet™**
EX9-AC100 MJ -X12

Applicable
protocol

MJ	CC-Link
DN	DeviceNet™

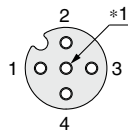

Socket connector
pin arrangement
A-coded (Normal key)

For CC-Link

Dimensions

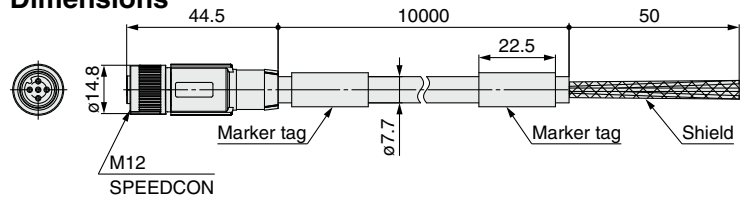

Connections

Terminal no.	Core wire color: Signal name (CC-Link)
1	Shield: SLD
2	White: DB
3	Yellow: DG
4	Blue: DA

*1 Number of holes: 5, Total number of pins: 4

Item		Specifications
Cable O.D.		ø7.7 mm
Conductor nominal cross section	Data pair	0.5 mm ² /AWG20
	Drain	0.34 mm ² /AWG22
Wire O.D. (Including insulator)		2.55 mm
Min. bending radius (Fixed)		77 mm

For DeviceNet™

Dimensions

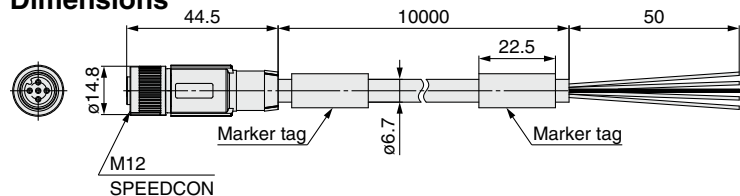

Connections

Terminal no.	Core wire color: Signal name (DeviceNet™)
1	Shield: DRAIN
2	Red: V+
3	Black: V-
4	White: CAN H
5	Blue: CAN L

Item		Specifications
Cable O.D.		ø6.7 mm
Conductor nominal cross section	Power pair	0.34 mm ² /AWG22
	Data pair	0.25 mm ² /AWG24
Wire O.D. (Including insulator)	Power pair	1.4 mm
	Data pair	2.05 mm
Min. bending radius (Fixed)		67 mm

Power Supply Cable

① **With connector on one side (Socket)**

Cable length: 10000 mm

For CC-Link

EX9-AC100-1-X16

Dimensions

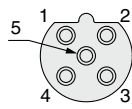
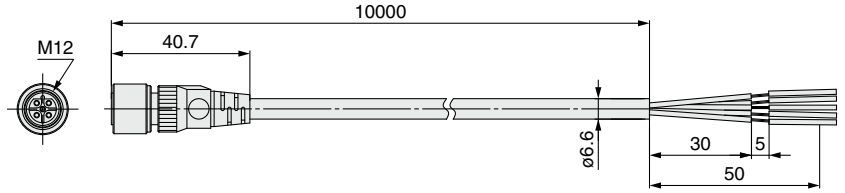

Socket connector
pin arrangement
B-coded (Reverse key)

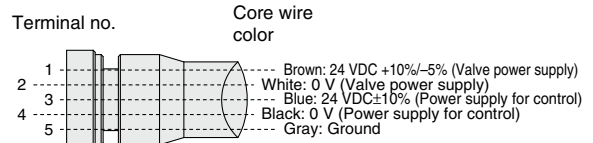

Connections

Item	Specifications
Cable O.D.	ø6 mm
Conductor nominal cross section	0.3 mm ² /AWG22
Wire O.D. (Including insulator)	1.65 mm
Min. bending radius (Fixed)	40 mm

Type 1	EX260
Type 1	EX123/124/126
Type 2	EX500
Type 3	EX600
Type 3	EX245
Type 3	EX250
Type 1	EX120/121/122
Type 1	EX140
Type 1	EX180
Type 2	EX510
	M8/M12
	ATEX

EX250 Series

Power Supply Cable

② With connector on one side (Socket)

Cable length: 10000 mm

For PROFIBUS DP

For EtherNet/IP™

Straight connector type

EX500-AP100-S-X1

Connector specification

S Straight

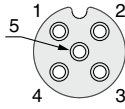
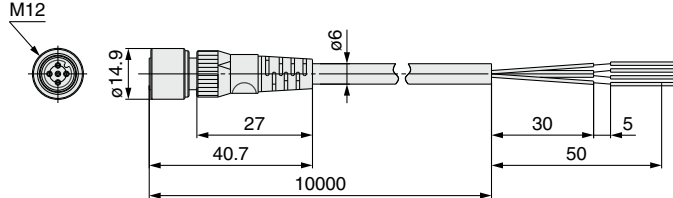

Socket connector pin arrangement
A-coded

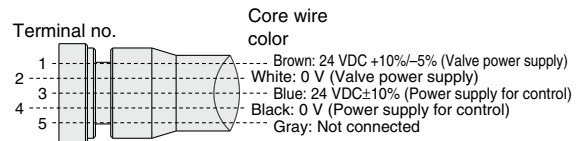

Connections (PROFIBUS DP, EtherNet/IP™)

Item	Specifications
Cable O.D.	ø6 mm
Conductor nominal cross section	0.3 mm ² /AWG22
Wire O.D. (Including insulator)	1.5 mm
Min. bending radius (Fixed)	40 mm



EX250 Series Specific Product Precautions

Be sure to read this before handling the products. Refer to page 277 for safety instructions. For fieldbus system precautions, refer to pages 278 to 280 and the "Operation Manual" on the SMC website: <http://www.smcworld.com>

When one AS-Interface power supply system is used

⚠ Caution

	EX250-SAS7	EX250-SAS9	
Power supply voltage	Supplied from AS-Interface circuit, 26.5 to 31.6 VDC*1		
Internal current consumption	Max. 100 mA	Max. 65 mA	
Input/output specification	Number of inputs	8	
	Number of outputs	8	
	Supply voltage	24 VDC	
	Supply current*2	Max. 240 mA	Max. 120 mA

- *1 For communication power supply, use a power supply dedicated to AS-Interface. For details, please refer to operation manuals provided by the respective manufacturers.
- *2 The AS-Interface circuit provides current to the internal parts of the SI unit and all connected equipment. Since there is a limit on the possible supply current to all connected equipment, select the equipment connected to the input/output device to stay within the possible supply current.

Example) When EX250-SAS9 is used

$$\begin{aligned} &\text{Valve: VQC1100NY} - 5 \text{ (low-wattage type of 0.5 W) } \times 4 \text{ pcs.} \\ &0.5 \text{ [W]} \div 24 \text{ [V]} \times 4 \text{ [pcs.]} \\ &= 84 \text{ [mA]} \text{ (4 outputs simultaneously ON)} \end{aligned}$$

The maximum possible supply current of EX250-SAS9 is 120 mA. Therefore, the possible supply current to the sensor is $120 \text{ [mA]} - 84 \text{ [mA]} = 36 \text{ [mA]}$

Use of low-wattage type valves by minimizing the maximum number of simultaneous outputs, and low current consumption sensors (2-wire sensor, etc.) is recommended.

Maximum number of AS-Interface compatible input blocks

SI unit specifications		Input block type		Input block maximum stations
EX250-SAS3	AS-Interface 8in/8out 31 Slave Mode, 2 power supply systems	1	M12/2 inputs	4 stations
		2	M12/4 inputs	2 stations
		3	M8/4 inputs	2 stations
EX250-SAS5	AS-Interface 4in/4out 31 Slave Mode, 2 power supply systems	1	M12/2 inputs	2 stations
		2	M12/4 inputs	1 station
		3	M8/4 inputs	1 station
EX250-SAS7	AS-Interface 8in/8out 31 Slave Mode, 1 power supply system	1	M12/2 inputs	4 stations
		2	M12/4 inputs	2 stations
		3	M8/4 inputs	2 stations
EX250-SAS9	AS-Interface 4in/4out 31 Slave Mode, 1 power supply system	1	M12/2 inputs	2 stations
		2	M12/4 inputs	1 station
		3	M8/4 inputs	1 station

Operating Environment

⚠ Caution

1. Select the proper type of enclosure according to the environment of operation.

IP65 is achieved when the following conditions are met.

- 1) Provide appropriate wiring between all units using electrical wiring cables, communication connectors and cables with M12 connectors.
- 2) Suitable mounting of each unit and valve manifold.
- 3) Be sure to mount a seal cap on any unused connectors. If using in an environment that is exposed to water splashes, please take measures such as using a cover.

■ Trademark

Modbus® is a registered trademark of Schneider Electric, licensed to the Modbus Organization, Inc.
 DeviceNet™ is a trademark of ODVA.
 EtherNet/IP™ is a trademark of ODVA.
 QuickConnect™ is a trademark of ODVA.

Type 1	EX260
Type 1	EX123/124/126
Type 2	EX500
Type 2	EX600
Type 3	EX245
Type 3	EX250
Type 1	EX120/121/122
Type 1	EX140
Type 1	EX180
Type 2	EX510
Type 2	M8/M12
Type 2	ATEX