

# Low-Speed Rotary Actuator

## CRQ2X/MSQX Series

CRQ2 Size: 10, 15, 20, 30, 40 MSQX Size: 10, 20, 30, 50

Possible to transfer a workpiece at low-speed.

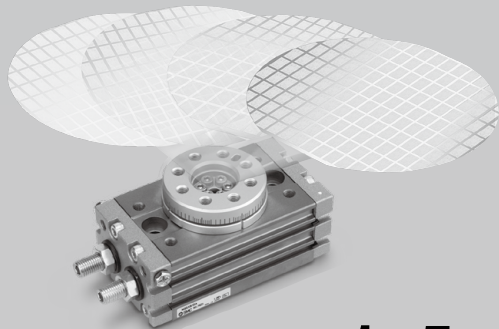

- Rotation time adjustment range: **1 to 5** (s/90°)

Model	Size	Rotation time adjustment range (s/90°)					
		1	2	3	4	5	
Low-speed	CRQ2X	10, 15, 20, 30, 40	1 to 5 (0.7 to 5 for CRQ2X□10,15)				
	MSQX	10, 20, 30, 50	—				
Standard	CRQ2	10, 15, 20, 30, 40	0.2 to 1	1 (0.2 to 0.7 for CRQ2□10,15)			
	MSQ	10, 20, 30, 50	—				

- Realized a stable motion at 5 s/90°.

Smooth motion without stick-slip phenomenon

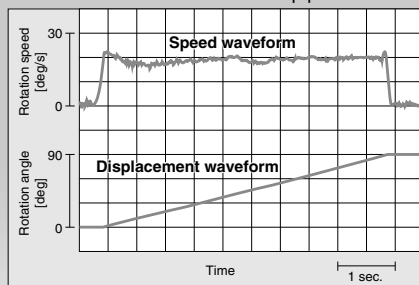

Measurement conditions / Fluid: Air

Mounting orientation: Vertical without load  
 Operating pressure: 0.5 MPa  
 Pneumatic circuit: Meter-out circuit  
 Ambient temperature: Room temperature

- Dimensions compatible with the CRQ2, MSQ series

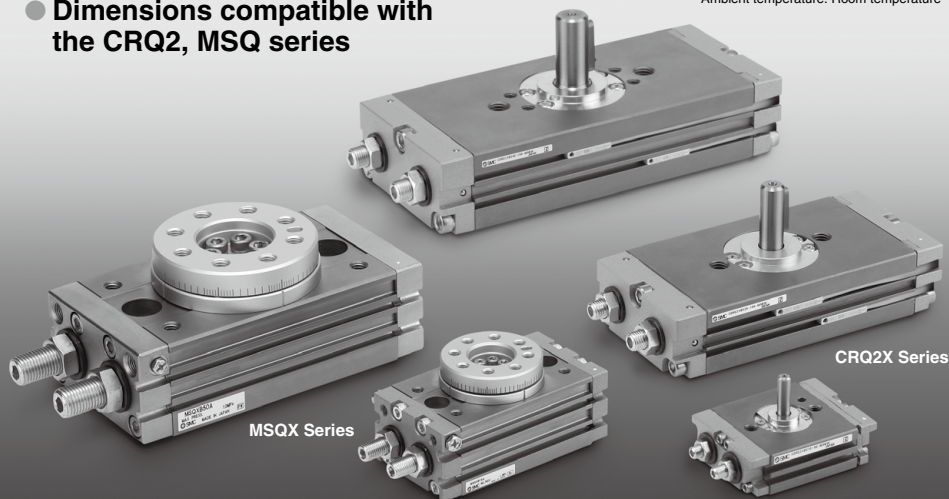

# CRQ2X/MSQX Series

## Model Selection

\* The selection procedure of the rotary for low-speed is the same as for an ordinary rotary. If the rotation time exceeds 2s per 90°, however, the necessary torque and the kinetic energy are calculated with rotation time of 2s per 90°.

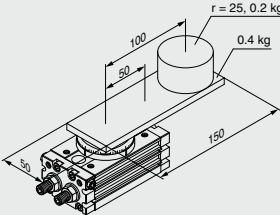
Selection Procedure	Remarks	Selection Example
<p><b>0</b> Operating conditions</p> <p>Operating conditions are as follows:</p> <ul style="list-style-type: none"> <li>• Provisionally selected model</li> <li>• Operating pressure: MPa</li> <li>• Mounting position</li> <li>• Load type           <ul style="list-style-type: none"> <li>Static load: N·m</li> <li>Resistance load: N·m</li> <li>Inertial load: N·m</li> </ul> </li> <li>• Load dimension: m</li> <li>• Load mass: kg</li> <li>• Rotation time: s</li> <li>• Rotation angle: rad</li> </ul>	<ul style="list-style-type: none"> <li>• See P. 380 for load type.</li> <li>• The unit of the rotation angle is Radians.  <math>180^\circ = \pi \text{ rad}</math>  <math>90^\circ = \pi/2 \text{ rad}</math></li> </ul>	 <p>Provisionally selected model: MSQXB10A        Operating pressure: 0.3 MPa        Mounting position: Vertical, Type of load: Inertial load        Rotation time: t = 6s    Rotation angle: <math>\theta = \pi \text{ rad}</math> (180°)</p>
<p><b>1</b> Calculation of moment of inertia</p> <p>Calculate the moment of inertia of the load.        ⇒ P. 379</p>	<ul style="list-style-type: none"> <li>• If the moment of inertia of the load is made up of multiple components, calculate the moment of inertia of each component and add them together.</li> </ul>	<p>Load 1 moment of inertia: <math>I_1</math>  <math>I_1 = 0.4 \times \frac{0.15^2 + 0.05^2}{12} + 0.4 \times 0.05^2 = 0.001833</math></p> <p>Load 2 moment of inertia: <math>I_2</math>  <math>I_2 = 0.2 \times \frac{0.025^2}{2} + 0.2 \times 0.1^2 = 0.002063</math></p> <p>Total moment of inertia: <math>I</math>  <math>I = I_1 + I_2 = 0.003896 \text{ [kg} \cdot \text{m}^2\text{]}</math></p>
<p><b>2</b> Calculation of necessary torque</p> <p>Calculate necessary torque corresponding to the load type, and ensure it is within effective torque range.</p> <ul style="list-style-type: none"> <li>• Static load (Ts) Necessary torque <math>T = T_s</math></li> <li>• Resistance load (Tf) Necessary torque <math>T = T_f \times (3 \text{ to } 5)</math></li> <li>• Inertial load (Ta) Necessary torque <math>T = T_a \times 10</math>            ⇒ P. 380</li> </ul>	<ul style="list-style-type: none"> <li>• When calculating the inertial load, if the rotation time exceeds 2s per 90°, inertial load is calculated with rotation time of 2s per 90°.</li> <li>• Even for resistance load, when the load is rotated, necessary torque calculated from inertial load shall be added.</li> </ul> <p>Necessary torque <math>T = T_f \times (3 \text{ to } 5) + T_a \times 10</math></p>	<p>Inertial load: <math>T_a</math>  <math>T_a = I \cdot \omega</math>  <math>\omega = \frac{2\theta}{t^2} \text{ [rad/s}^2\text{]}</math></p> <p>Necessary torque: <math>T</math>  <math>T = T_a \times 10</math>  <math>= 0.003896 \times \frac{2 \times \pi}{4^2} \times 10 = 0.015 \text{ [N} \cdot \text{m]}</math>        (t is calculated with 2s per 90°.)  <math>0.015 \text{ N} \cdot \text{m} &lt; \text{Effective torque OK}</math></p>
<p><b>3</b> Checking rotation time</p> <p>Confirm that it is within the adjustable range of rotation time.        ⇒ P. 381</p>	<ul style="list-style-type: none"> <li>• Converted to the time per 90° for comparison. (For comparison, <math>6\text{s}/180^\circ</math> is converted to <math>3\text{s}/90^\circ</math>.)</li> </ul>	<p><math>1.0 \leq t \leq 5</math></p> <p><math>t = 3\text{s}/90^\circ \text{ OK}</math></p>
<p><b>4</b> Calculation of kinetic energy</p> <p>Confirm that the load's kinetic energy is within the allowable value.</p> <p>Can be confirmed by the graph of the moment of inertia and the rotation time.        ⇒ P. 381</p>	<ul style="list-style-type: none"> <li>• If the rotation time exceeds 2s per 90°, kinetic energy is calculated with rotation time of 2s per 90°.</li> <li>• If the allowable value is exceeded, an external cushioning mechanism such as an absorber needs to be installed.</li> </ul>	<p><math>E = \frac{1}{2} \cdot I \cdot \omega^2</math>  <math>\omega = \frac{2 \cdot \theta}{t}</math></p> <p>Kinetic energy  <math>\frac{1}{2} \times 0.003896 \times \left(\frac{2 \times \pi}{4}\right)^2 = 0.0048 \text{ [J]}</math>        (t is calculated with 2s per 90°.)  <math>0.0048 \text{ [J]} &lt; \text{Allowable energy OK}</math></p>
<p><b>5</b> Checking allowable load</p> <p>Check if the load applied to the product is within the allowable range.        ⇒ P. 382</p>	<ul style="list-style-type: none"> <li>• If the allowable value is exceeded, an external bearing needs to be installed.</li> </ul>	<p><math>M = 0.4 \times 9.8 \times 0.05 + 0.2 \times 9.8 \times 0.1</math>  <math>= 0.392 \text{ [N} \cdot \text{m]}</math></p> <p><math>0.392 \text{ [N} \cdot \text{m]} &lt; \text{Allowable moment load OK}</math></p>
<p><b>6</b> Calculation of air consumption and necessary air quantity</p>		

Calculate air consumption and necessary air quantity as required. ⇒ P. 383

**Equation Table of Moment of Inertia (Calculation of moment of inertia I)** I: Moment of inertia (kg·m<sup>2</sup>) m: Load mass (kg)

**1. Thin shaft**

Position of rotational axis:  
Perpendicular to the shaft through the center of gravity

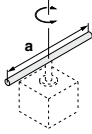

$$I = m \cdot \frac{a^2}{12}$$

**2. Thin rectangular plate**

Position of rotational axis:  
Parallel to side b through the center of gravity

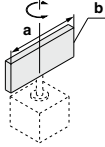

$$I = m \cdot \frac{a^2}{12}$$

**3. Thin rectangular plate (Including rectangular parallelepiped)**

Position of rotational axis:  
Perpendicular to the plate through the center of gravity

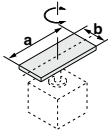

$$I = m \cdot \frac{a^2 + b^2}{12}$$

**4. Round plate (Including column)**

Position of rotational axis:  
Passing through the center axis

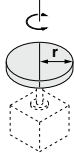

$$I = m \cdot \frac{r^2}{2}$$

**5. Solid sphere**

Position of rotational axis:  
Passing through the diameter

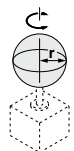

$$I = m \cdot \frac{2r^2}{5}$$

**6. Thin round plate**

Position of rotational axis:  
Passing through the diameter

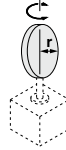

$$I = m \cdot \frac{r^2}{4}$$

**7. Cylindrical**

Position of rotational axis:  
Passing through the diameter and the center of gravity

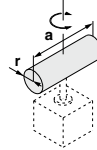

$$I = m \cdot \frac{3r^2 + a^2}{12}$$

**8. When rotational axis and the center of the load are not concentric.**

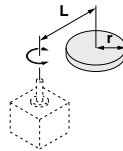

$$I = K + m \cdot L^2$$

**K:** The moment of inertia around the center of gravity of the load

In case of 4. Round plate  $K = m \cdot \frac{r^2}{2}$

**9. Gear transmission**

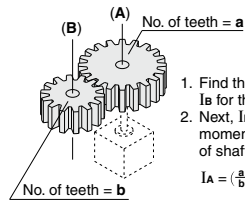

1. Find the moment of inertia  $I_B$  for the rotation of shaft (B).
2. Next,  $I_B$  is entered to find  $I_A$  the moment of inertia for the rotation of shaft (A) as

$$I_A = \left(\frac{a}{b}\right)^2 \cdot I_B$$

# CRQ2X/MSQX Series

## Load Type

Calculation method of necessary torque depends on the load type. Refer to the table below.

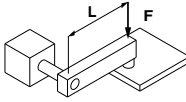
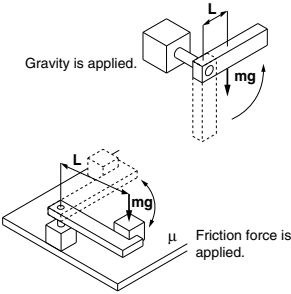
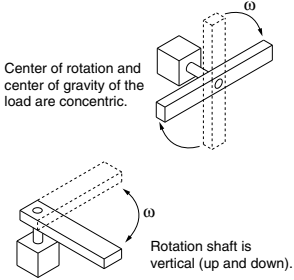
Load type		
Static load: $T_s$	Resistance load: $T_f$	Inertial load: $T_a$
<p>Only pressing force is necessary. (e.g. for clamping)</p> 	<p>Weight or friction force is applied to rotating direction.</p> 	<p>Rotate the load with inertia.</p> 
<p><math>T_s = F \cdot L</math></p> <p><math>T_s</math> : Static load (N·m)  <math>F</math> : Clamping force (N)  <math>L</math> : Distance from the rotation center to the clamping position (m)</p>	<p>Gravity is applied in rotating direction.</p> <p><math>T_f = m \cdot g \cdot L</math></p> <p>Friction force is applied in rotating direction.</p> <p><math>T_f = \mu \cdot m \cdot g \cdot L</math></p> <p><math>T_f</math> : Resistance load (N·m)  <math>m</math> : Load mass (kg)  <math>g</math> : Gravitational acceleration 9.8 (m/s<sup>2</sup>)  <math>L</math> : Distance from the rotation center to the point of application of the weight or friction force (m)  <math>\mu</math> : Friction coefficient</p>	<p><math>T_a = I \cdot \omega = I \cdot \frac{2\theta}{t^2}</math></p> <p><math>T_a</math> : Inertial load (N·m)  <math>I</math> : Moment of inertia (kg·m<sup>2</sup>)  <math>\omega</math> : Angular acceleration (rad/s<sup>2</sup>)  <math>\theta</math> : Rotation angle (rad)  <math>t</math> : Rotation time (s)</p> <p>For low speed rotary, if the rotation time exceeds 2s per 90°, inertial load is calculated with rotation time of 2s per 90°.</p>
Necessary torque: $T = T_s$	Necessary torque: $T = T_f \times (3 \text{ to } 5)$ <sup>Note)</sup>	Necessary torque: $T = T_a \times 10$ <sup>Note)</sup>
<p>• Resistance load: Gravity or friction force is applied to rotating direction.            Ex. 1) Rotation shaft is horizontal (lateral), and the rotation center and the center of gravity of the load are not concentric.            Ex. 2) Load moves by sliding on the floor            * The total of resistance load and inertial load is the necessary torque. <math>T = T_f \times (3 \text{ to } 5) + T_a \times 10</math></p> <p>• Not resistance load: Neither weight or friction force is applied in rotating direction.            Ex. 1) Rotation shaft is vertical (up and down).            Ex. 2) Rotation shaft is horizontal (lateral), and rotation center and the center of gravity of the load are not concentric.            * Necessary torque is inertial load only. <math>T = T_a \times 10</math></p> <p style="text-align: right;">Note) To adjust the speed, margin is necessary for <math>T_f</math> and <math>T_a</math>.</p>		

## Effective Torque

Unit: N·m

Model	Size	Operating pressure (MPa)										
		0.1	0.15	0.2	0.3	0.4	0.5	0.6	0.7	0.8	0.9	1.0
CRQ2X	10	—	0.09	0.12	0.18	0.24	0.30	0.36	0.42	—	—	—
	15	—	0.22	0.30	0.45	0.60	0.75	0.90	1.04	—	—	—
	20	0.37	0.55	0.73	1.10	1.47	1.84	2.20	2.57	2.93	3.29	3.66
	30	0.62	0.94	1.25	1.87	2.49	3.11	3.74	4.37	4.99	5.60	6.24
	40	1.06	1.59	2.11	3.18	4.24	5.30	6.36	7.43	8.48	9.54	10.6
MSQX	10	0.18	—	0.36	0.53	0.71	0.89	1.07	1.25	1.42	1.60	1.78
	20	0.37	—	0.73	1.10	1.47	1.84	2.20	2.57	2.93	3.29	3.66
	30	0.55	—	1.09	1.64	2.18	2.73	3.19	3.82	4.37	4.91	5.45
	50	0.93	—	1.85	2.78	3.71	4.64	5.57	6.50	7.43	8.35	9.28

**CRQ2X**

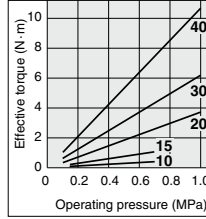

**MSQX**

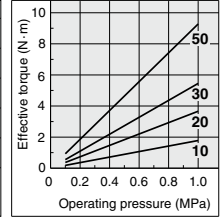

Note 1) Values of operating torque in the above table are representative values, and not guaranteed. Make use of the values as a reference when ordering.  
 Note 2) Except for cases when an external stopper is used, the holding torque at the operation end is half of the table value.

## Kinetic Energy/Rotating Time

In a rotational movement, the kinetic energy of a load may damage the internal parts, even if the required torque for a load is small. Consider the moment of inertia and rotation time before selecting a model.  
 (For model selection, refer to the moment of inertia and rotation time graph as shown on the below table.)

### Allowable kinetic energy and rotation time adjustment range

Set the rotation time, within stable operational guidelines, using the adjustment range specification table as detailed below. When operating at low-speeds which exceed the rotation time adjustment range, use caution as it may result in sticking or malfunction.

Model	Size	Allowable kinetic energy (J)	Stable operational rotation time adjustment range (s/90°)
CRQ2X	10	0.00025	0.7 to 5
	15	0.00039	
	20	0.025	
	30	0.048	
	40	0.081	
MSQX	10	0.007	1 to 5
	20	0.025	
	30	0.048	
	50	0.081	

## Model Selection

Select a model based on the moment of inertia and rotation time as shown graph below.

**CRQ2X**

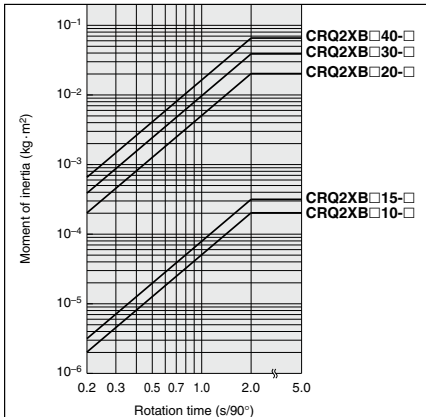

**MSQX**

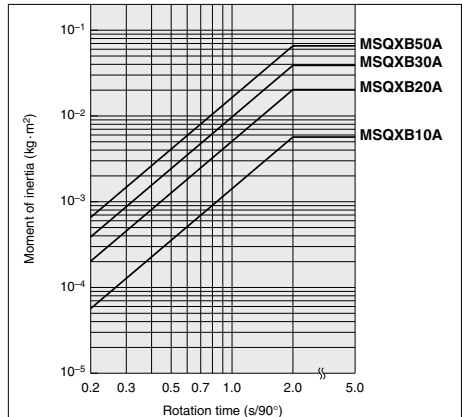

\* If the rotation time exceeds 2 s per 90°, kinetic energy is calculated with rotation time of 2 s per 90°.

# CRQ2X/MSQX Series

## Allowable Load

### CRQ2X

A load up to the allowable radial/thrust load can be applied provided that a dynamic load is not generated. However, applications which apply a load directly to the shaft should be avoided whenever possible. In order to further improve the operating conditions, a method such as that shown in the drawing on the right side is recommended so that a direct load is not applied to the shaft.

Size			
	Allowable radial load (N)	Allowable thrust load (N)	
		(a)	(b)
10	14.7	7.8	15.7
15	19.6	9.8	19.6
20	49	29.4	49
30	78	49	98
40	98	59	108

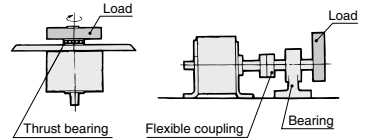

### MSQX

Do not allow the load and moment applied to the table to exceed the allowable values shown in the table below. (Operation beyond the allowable values can cause adverse effects on service life, such as play in the table and loss of accuracy.)

Size				
	Allowable radial load (N)	Allowable thrust load (N)		Allowable moment (N·m)
		(a)	(b)	
10	78	74	78	2.4
20	147	137	137	4.0
30	196	197	363	5.3
50	314	296	451	9.7

# Rotary Actuator Technical Data

## Air Consumption

Air consumption is the volume of air which is expended by the rotary actuator's reciprocal operation inside the actuator and in the piping between the actuator and the switching valve, etc. This is necessary for selection of a compressor and for calculation of its running cost.

\* The air consumption (Q<sub>CR</sub>) required for one reciprocation of the rotary actuator alone is shown in the table below, and can be used to simplify the calculation.

### Formulas

$$Q_{CR} = 2V \times \left( \frac{P + 0.1}{0.1} \right) \times 10^{-3}$$

$$Q_{CP} = 2 \times a \times L \times \left( \frac{P}{0.1} \right) \times 10^{-6}$$

$$Q_C = Q_{CR} + Q_{CP}$$

- Q<sub>CR</sub> = Air consumption of rotary actuator [L (ANR)]  
 Q<sub>CP</sub> = Air consumption of tubing or piping [L (ANR)]  
 V = Internal volume of rotary actuator [cm<sup>3</sup>]  
 P = Operating pressure [MPa]  
 L = Length of piping [mm]  
 a = Internal cross section of piping [mm<sup>2</sup>]  
 Q<sub>C</sub> = Air consumption required for one reciprocation of rotary actuator [L (ANR)]

When selecting a compressor, it is necessary to choose one which has sufficient reserve for the total air consumption of pneumatic actuators downstream. This is affected by factors such as leakage in piping, consumption by drain valves and pilot valves, etc., and reduction of air volume due to drops in temperature.

### Formulas

$$Q_{C2} = Q_C \times n \times \text{Number of actuators} \times \text{Reserve factor}$$

- Q<sub>C2</sub> = Compressor discharge flow rate [L/min (ANR)]  
 n = Actuator reciprocations per minute

Reserve factor: 1.5 or greater

### Internal Cross Section of Tubing and Steel Piping

Nominal size	O.D. (mm)	I.D. (mm)	Internal cross section a (mm <sup>2</sup> )
T□0425	4	2.5	4.9
T□0604	6	4	12.6
TU0805	8	5	19.6
T□0806	8	6	28.3
1/8B	—	6.5	33.2
T□1075	10	7.5	44.2
TU1208	12	8	50.3
T□1209	12	9	63.6
1/4B	—	9.2	66.5
TS1612	16	12	113
3/8B	—	12.7	127
T□1613	16	13	133
1/2B	—	16.1	204
3/4B	—	21.6	366
1B	—	27.6	598

### Air Consumption

Air consumption: Q<sub>CR</sub> L (ANR)

Model	Size	Rotation angle (°)	Internal volume V (cm <sup>3</sup> )	Operating pressure (MPa)										
				0.1	0.15	0.2	0.3	0.4	0.5	0.6	0.7	0.8	0.9	1.0
CRQ2X	10	90	1.2	—	0.006	0.007	0.009	0.012	0.014	0.016	0.018	—	—	—
		180	2.2	—	0.011	0.013	0.018	0.022	0.026	0.031	0.035	—	—	—
	15	90	2.9	—	0.015	0.017	0.023	0.029	0.035	0.041	0.046	—	—	—
		180	5.5	—	0.028	0.033	0.044	0.055	0.066	0.077	0.088	—	—	—
	20	90	7.1	0.028	0.036	0.043	0.057	0.071	0.085	0.099	0.114	0.128	0.142	0.156
		180	13.5	0.054	0.068	0.081	0.108	0.135	0.162	0.189	0.216	0.243	0.270	0.297
	30	90	12.1	0.048	0.060	0.073	0.097	0.121	0.145	0.169	0.193	0.218	0.242	0.266
		180	23.0	0.092	0.115	0.138	0.184	0.230	0.276	0.322	0.368	0.413	0.459	0.505
40	90	20.6	0.082	0.103	0.123	0.164	0.206	0.247	0.288	0.329	0.370	0.411	0.452	
	180	39.1	0.156	0.195	0.234	0.313	0.391	0.469	0.547	0.625	0.703	0.781	0.859	
MSQX	190	10	6.6	0.026	0.033	0.040	0.053	0.066	0.079	0.092	0.106	0.119	0.132	0.145
		20	13.5	0.054	0.068	0.081	0.108	0.135	0.162	0.189	0.216	0.243	0.270	0.297
		30	20.1	0.080	0.101	0.121	0.161	0.201	0.241	0.281	0.322	0.362	0.402	0.442
		50	34.1	0.136	0.171	0.205	0.273	0.341	0.409	0.477	0.546	0.614	0.682	0.750

# Low-Speed Compact Rotary Actuator Rack & Pinion Type

## CRQ2X Series

Size: 10, 15, 20, 30, 40

### How to Order

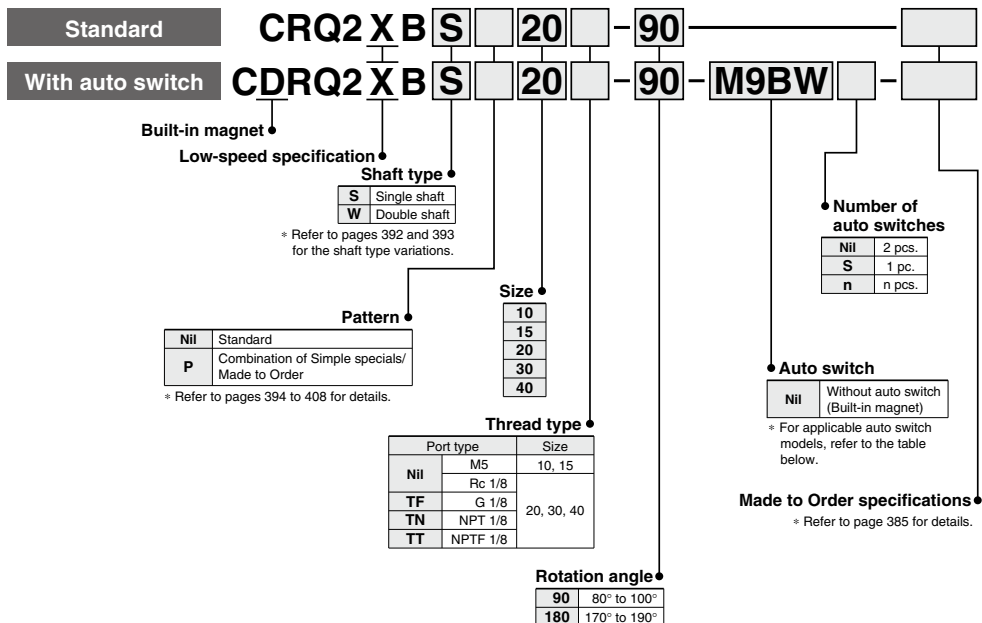

### Applicable Auto Switches

Refer to pages 929 to 983 for detailed auto switch specification.

Type	Special function	Electrical entry	Indicator light	Wiring (Output)	Load voltage		Auto switch model		Lead wire length (m) *			Pre-wired connector	Applicable load		
					DC	AC	Perpendicular	In-line	0.5 (Nil)	1 (M)	3 (L)		5 (Z)	IC circuit	Relay, PLC
Solid state auto switch	—	Grommet	Yes	3-wire (NPN)	24 V	—	M9NV	M9N	●	●	●	○	—	—	
				3-wire (PNP)			M9PV	M9P	●	●	●	○			
				2-wire			M9BV	M9B	●	●	●	○			
				3-wire (NPN)			M9NVW	M9NW	●	●	●	○			
	Diagnostic indication (2-color indicator)			3-wire (PNP)	M9PWW	M9PW	●	●	●	○	○	○	IC circuit	Relay, PLC	
				2-wire	M9BWW	M9BW	●	●	●	○	○	○	—		
				3-wire (NPN)	M9NAV <sup>*1</sup>	M9NA <sup>*1</sup>	○	○	●	○	○	○	IC circuit		
				3-wire (PNP)	M9PAV <sup>*1</sup>	M9PA <sup>*1</sup>	○	○	●	○	○	○	IC circuit		
Water resistant (2-color indicator)	2-wire	M9BAV <sup>*1</sup>	M9BA <sup>*1</sup>	○	○	●	○	○	○	—					
	3-wire (NPN)	—	5 V	—	A96V	A96	●	●	—	—	—	—	IC circuit	—	
	3-wire (PNP)				A93V <sup>*2</sup>	A93	●	●	●	—	—	—	—		
	2-wire				A90V	A90	●	—	—	—	—	—	—		IC circuit
2-wire	—				—	—	—	—	—	—	—	—	—		

\*1 Although it is possible to mount water resistant type auto switches, note that the rotary actuator itself is not of water resistant construction.  
\*2 1 m type lead wire is only applicable to D-A93.

\* Lead wire length symbols: 0.5 m ..... Nil  
1 m ..... M  
3 m ..... L  
5 m ..... Z  
(Example) M9NW  
(Example) M9NWM  
(Example) M9NWL  
(Example) M9NWZ

\* Auto switches marked with a "○" are produced upon receipt of orders.

\* Refer to pages 970 and 971 for the details of solid state auto switch with pre-wired connector.

\* Auto switches are shipped together, (but not assembled).



## Specifications

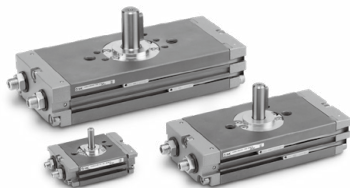

Size	10	15	20	30	40
<b>Fluid</b>	Air (Non-lube)				
<b>Max. operating pressure</b>	0.7 MPa		1 MPa		
<b>Min. operating pressure</b>	0.15 MPa		0.1 MPa		
<b>Ambient and fluid temperature</b>	0° to 60°C (No freezing)				
<b>Cushion</b>	Not attached				
<b>Angle adjustment range</b>	Rotation end $\pm 5^\circ$				
<b>Rotation angle</b>	80° to 100°, 170° to 190°				
<b>Port size</b>	M5 x 0.8		Rc 1/8, G 1/8, NPT 1/8, NPTF 1/8		
<b>Output (N·m)*</b>	0.30	0.75	1.8	3.1	5.3

\* Output under the operating pressure at 0.5 MPa. Refer to page 381 for further information.

## Symbol



**Made to Order**  
(Refer to pages 394 to 408 for details.)

Symbol	Specifications/Content	Applicable shaft type
—	Shaft type variation	X, Y, Z, T, J, K
<b>XA1 to XA24</b>	Shaft pattern sequencing I	S, W
<b>XA31 to XA59</b>	Shaft pattern sequencing II	X, Y, Z, T, J, K
<b>XC7</b>	Reversed shaft	S, W, X, T, J
<b>XC8 to XC11</b>	Change of rotating range	S, W, Y X*, Z*, T*, J*, K*
<b>XC12 to XC15</b>	Change of angle adjustable range (0° to 100°)*	
<b>XC16, XC17</b>	Change of angle adjustable range (90° to 190°)*	
<b>XC18, XC19</b>	Change of rotating range	
<b>XC20, XC21</b>	Change of angle adjustable range (90° to 190°)*	
<b>X6</b>	Shaft and parallel key made of stainless steel	

\* Among the symbols XC8 to XC21, only XC12 and XC16 are compatible with shaft types X, Z, T, J and K.

## Allowable Kinetic Energy and Rotation Time Adjustment Range

Size	Allowable kinetic energy (J)	Stable operational rotation time adjustment range (s/90°)
<b>10</b>	0.00025	0.7 to 5
<b>15</b>	0.00039	
<b>20</b>	0.025	
<b>30</b>	0.048	1 to 5
<b>40</b>	0.081	

(Note) If operated where the kinetic energy exceeds the allowable value, this may cause damage to the internal parts and result in product failure. Please pay special attention to the kinetic energy levels when designing, adjusting and during operation to avoid exceeding the allowable limit.

## Weight

Size	Standard weight*(g)	
	90°	180°
<b>10</b>	120	150
<b>15</b>	220	270
<b>20</b>	600	700
<b>30</b>	900	1100
<b>40</b>	1400	1600

\* Not including the weight of auto switch.

## Moisture Control Tube IDK Series



When operating an actuator with a small diameter and a short stroke at a high frequency, the dew condensation (water droplet) may occur inside the piping depending on the conditions.

Simply connecting the moisture control tube to the actuator will prevent dew condensation from occurring. For details, refer to [the Web Catalog](#).

# CRQ2X Series

## Rotation Range

When pressurized from the port indicated by the arrow, the shaft will rotate in a clockwise direction.

**Rotation angle: 90°**

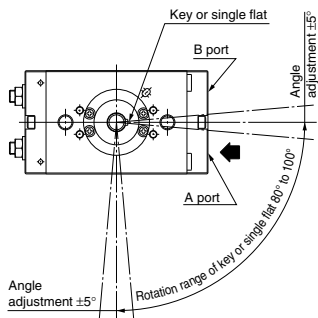

**Rotation angle: 180°**

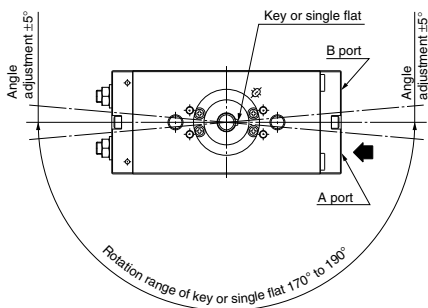

## Construction

Standard  
Size 10/15

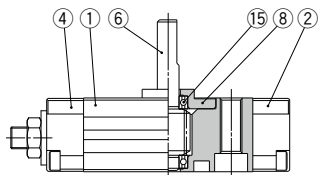
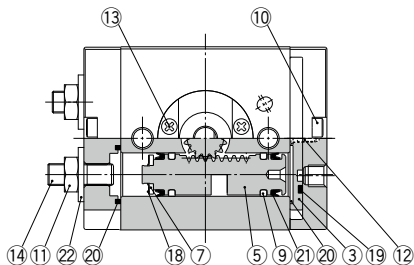

Standard  
Size 20/30/40

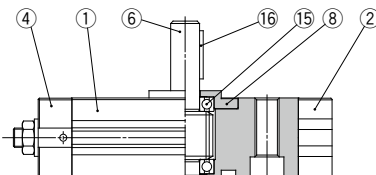
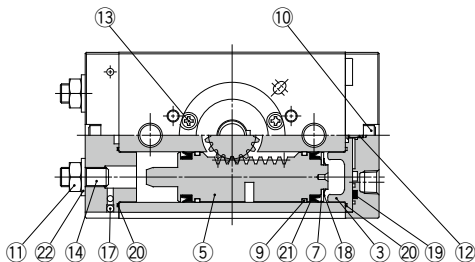

### Component Parts

No.	Description	Material
1	Body	Aluminum alloy
2	Cover	Aluminum alloy
3	Plate	Aluminum alloy
4	End cover	Aluminum alloy
5	Piston	Stainless steel
6	Shaft	Size: 10, 15 Stainless steel
		Size: 20, 30, 40 Chrome molybdenum steel
7	Seal retainer	Aluminum alloy
8	Bearing retainer	Aluminum alloy
9	Wear ring	Resin
10	Hexagon socket head cap screw	Stainless steel
11	Size: 10, 15 Hexagon nut	Steel wire
	Size: 20, 30, 40 Small hexagon nut	

### Component Parts

No.	Description	Material
12	Cross recessed screw No. 0	Steel wire
13	Size: 10, 15 Cross recessed screw No. 0	Steel wire
	Size: 20, 30, 40 Cross recessed screw	
14	Hexagon socket head set screw	Chrome molybdenum steel
15	Bearing	Bearing steel
16	Size: 20, 30, 40 only Parallel key	Carbon steel
17	Size: 20, 30, 40 only Steel ball	Stainless steel
18	Type CS retaining ring	Stainless steel
19	Seal	NBR
20	Gasket	NBR
21	Piston seal	NBR
22	Seal washer	NBR
23	With auto switch only Magnet	—

### Replacement Parts

Description	Part no.					Note
	10	15	20	30	40	
Seal kit	P473010-23	P473020-23	P473030-23	P473040-23	P473050-23	A set of above numbers ⑨, ⑰, ⑳, ㉑ and ㉒

### Parts included in Seal Kit

No.	Description	Qty.	Note
9	Wear ring	4	
19	Seal	1	
20	Gasket for cover	2	Size: 10, 15
	Gasket for end cover	1	
	Gasket	4	Size: 20, 30, 40
21	Piston seal	4	
22	Seal washer	2	

\* A set includes all parts above.

A grease pack (10 g) is included. When only a grease pack is needed, order with the following part number.

Replacement parts/Grease pack part no: P523010-21 (10 g)

# CRQ2X Series

## Construction

With auto switch  
Size 10/15

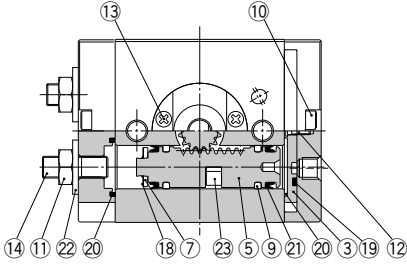

With auto switch  
Size 20/30/40

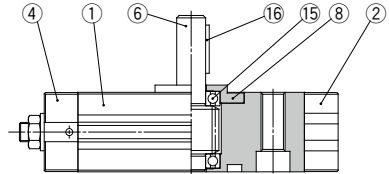
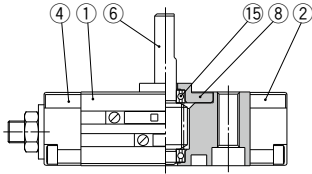
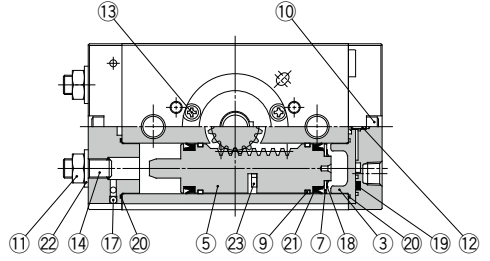



# CRQ2X Series

## Dimensions

### Size 20/30/40

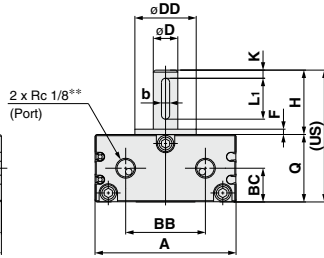
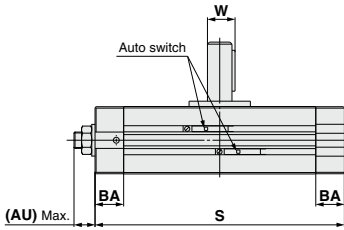
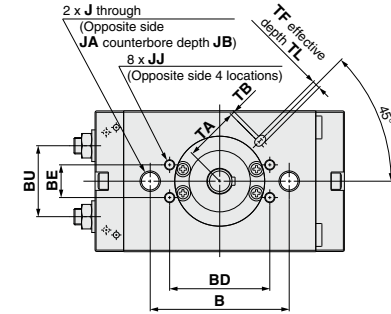

### With double shaft

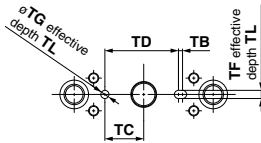
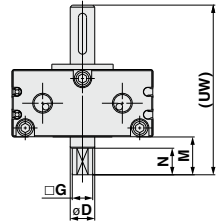

Size	Rotation angle	A	AU*	B	BA	BB	BC	BD	BE	BU	D (g6)	DD (h9)	F	H	J	JA	JB	JJ	K
20	90°, 180°	63	(11)	50	14	34	14.5	—	—	30.4	10	25	2.5	30	M8 x 1.25	11	6.5	—	3
30	90°, 180°	69	(11)	68	14	39	16.5	49	16	34.7	12	30	3	32	M10 x 1.5	14	8.5	M5 x 0.8 depth 6	4
40	90°, 180°	78	(13)	76	16	47	18.5	55	16	40.4	15	32	3	36	M10 x 1.5	14	8.6	M6 x 1 depth 7	5

Size	Rotation angle	Q	S	W	Key dimensions		US	TA	TB	TC	TD	TF (H9)	TG (H9)	TL	UW	G	M	N	L
					b	L1													
20	90°	29	104.4	11.5	4 <sup>0</sup> <sub>-0.03</sub>	20	59	24.5	1	13.5	27	4	4	2.5	74	8 <sup>0</sup> <sub>-0.1</sub>	15	11	9.6 <sup>0</sup> <sub>-0.1</sub>
	180°																		
30	90°	33	122	13.5	4 <sup>0</sup> <sub>-0.03</sub>	20	65	27	2	19	36	4	4	2.5	83	10 <sup>0</sup> <sub>-0.1</sub>	18	13	11.4 <sup>0</sup> <sub>-0.1</sub>
	180°																		
40	90°	37	139.3	17	5 <sup>0</sup> <sub>-0.03</sub>	25	73	32.5	2	20	39.5	5	5	3.5	93	10 <sup>0</sup> <sub>-0.1</sub>	20	15	14 <sup>0</sup> <sub>-0.1</sub>
	180°																		

\* The AU dimension is not the dimension at the time of shipment, since its dimension is for adjustment parts.

S: Upper 90°, Lower 180°

\*\* In addition to Rc 1/8, G 1/8, NPT 1/8 and NPTF 1/8 are also available.

### Unit Used as Flange Mount

The L dimensions of this unit are shown in the below table. When hexagon socket head cap bolt of the JIS standard is used, the head of the bolt will recess into the groove of actuator.

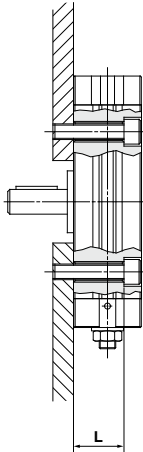

Size	L	Screw
10	13	M4
15	16	M4
20	22.5	M6
30	24.5	M8
40	28.5	M8

### Auto Switch Proper Mounting Position (at Rotation End Detection)

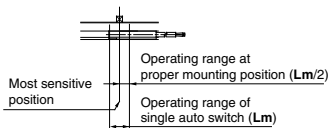
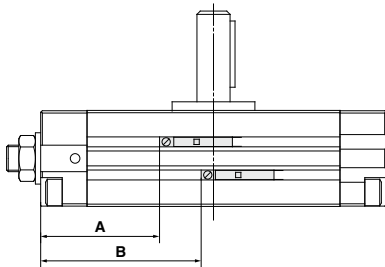

Size	Rotation angle	Solid state switch				Reed switch			
		A	B	Operating angle (θ m)	Hysteresis angle	A	B	Operating angle (θ m)	Hysteresis angle
10	90°	19	25.5	61°	5°	15	21.5	63°	12°
	180°	22	35			18	31		
15	90°	22.5	31	47°	4°	18.5	27	52°	9°
	180°	26.5	43.5			22.5	39.5		
20	90°	40	52.5	40°	4°	36	48.5	41°	9°
	180°	46	71.5			42	67.5		
30	90°	47	63	29°	2°	43	59	32°	7°
	180°	55	86			51	82		
40	90°	54	73	24°	2°	50	69	24°	5°
	180°	63.5	101.5			59.5	97.5		

Operating angle θm: Value of the operating range of single auto switch (Lm) as represented by rotation angle for shaft

Hysteresis angle: Value of the auto switch hysteresis as represented by angle

(Note) Since the above values are only provided as a guideline, they are not guaranteed.

In the actual setting, adjust them after confirming the auto switch operating condition.

# CRQ2X Series

## 1 Shaft Type Variation, Four Chamfers (Size 20/30/40) (Dimension parts different from the standard conform to the general tolerance.) Shaft Type: X, Z

CRQ2XB  
CDRQ2XB

Shaft type — Size — Rotating angle

Refer to "How to Order" on page 384 for further information.

X	Single shaft with four chamfers
Z	Double shaft with four chamfers

### Specifications

Fluid	Air (Non-lube)
Applicable shaft type	Single w/ four chamfers (X), Double w/ four chamfers (Z)
Applicable size	20, 30, 40
Max. operating pressure	1.0 MPa
Min. operating pressure	0.1 MPa
Cushion	Not attached
Rotation	80° to 100°, 170° to 190°
Port size	Rc 1/8, G 1/8, NPT 1/8, NPTF 1/8
Auto switch	Mountable

### Dimensions

Shaft type	X				Z			
Form								
Size	D (g6)	G	H	N	UX	UZ	M	
20	10	8 <sup>+0</sup> <sub>-0.1</sub>	21	11	50	65	15	
30	12	10 <sup>+0</sup> <sub>-0.1</sub>	24	13	57	75	18	
40	15	11 <sup>+0</sup> <sub>-0.1</sub>	27	15	64	84	20	

## 2 Shaft Type Variation, Double Shaft With Key (Size 20/30/40) (Dimension parts different from the standard conform to the general tolerance.) Shaft Type: Y

CRQ2XB  
CDRQ2XB

Y — Size — Rotating angle

Refer to "How to Order" on page 384 for further information.

Shaft type	Y	Double shaft with key
------------	---	-----------------------

### Dimensions

Y					
Size	D (g6)	W	H	UY	
20	10	11.5	30	89	
30	12	13.5	32	97	
40	15	17	36	109	

### Specifications

Fluid	Air (Non-lube)
Applicable shaft type	Double shaft with key (Y)
Applicable size	20, 30, 40
Max. operating pressure	1.0 MPa
Min. operating pressure	0.1 MPa
Cushion	Not attached
Rotating angle	80° to 100°, 170° to 190°
Port size	Rc 1/8, G 1/8, NPT 1/8, NPTF 1/8
Auto switch	Mountable



**3 Shaft Type Variation/Without Keyway** (Dimension parts different from the standard conform to the general tolerance.) **Shaft Type: T, J, K**

CRQ2XB  
CDRQ2XB

Shaft type    Size    Rotating angle

● Shaft type  
 ● Refer to "How to Order" on page 384 for further information.

<b>T</b>	Single round shaft
<b>J</b>	Double shaft (Without long shaft key, with four chamfers on short shaft, one chamfer on short shaft for 10 and 15.)
<b>K</b>	Double round shaft

**Specifications**

Fluid	Air (Non-lube)	
Applicable shaft type	Single round shaft (T), Double shaft (J), Double round shaft (K)	
Applicable size	10, 15	20, 30, 40
Max. operating pressure	0.7 MPa	1.0 MPa
Min. operating pressure	0.15 MPa	0.1 MPa
Cushion	Not attached	
Rotating angle	80° to 100°, 170° to 190°	
Port size	M5 x 0.8	Rc 1/8, G 1/8, NPT 1/8, NPTF 1/8
Auto switch	Mountable	

**Dimensions**

Shaft type	T				J				K	
Form										
					Size 10, 15 					
Size	D (g6)	G	W	H	M	N	UT	UJ	UK	
10	5	—	4.5	18	9	6	35	44	53	
15	6	—	5.5	20	10	7	40	50	60	
20	10	8 <sup>0</sup> <sub>-0.1</sub>	—	30	15	11	59	74	89	
30	12	10 <sup>0</sup> <sub>-0.1</sub>	—	32	18	13	65	83	97	
40	15	11 <sup>0</sup> <sub>-0.1</sub>	—	36	20	15	73	93	109	



**Shaft Pattern Sequencing I**

Symbol

**-XA1 to XA8**

**Additional Reminders**

1. Enter the dimensions within a range that allows for additional machining.
2. Unless indicated otherwise, the dimensional tolerance conforms to the general tolerance. SMC will make appropriate arrangements.
3. The length of the unthreaded portion is 2 to 3 pitches.
4. Unless specified otherwise, the thread pitch is based on coarse metric threads.  
M3 x 0.5, M4 x 0.7, M5 x 0.8  
M6 x 1
5. Enter the desired figures in the  $\square$  portion of the diagram.
6. XA1 to XA24 are the standard products that have been additionally machined.
7. Chamfer face of the parts machining additionally is C0.5.

**Symbol: A1**

Machine female threads into the long shaft.  
The maximum dimension L1 is, as a rule, twice the thread size (Example) For M3: L1 = 6  
• Applicable shaft types: S, W

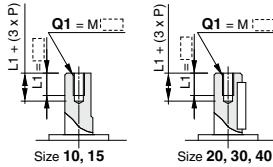

Size	Q1
10	M3
15	M3, M4
20	M3, M4
30	M3, M4, M5
40	M4, M5, M6

**Symbol: A2**

Machine female threads into the short shaft.  
The maximum dimension L2 is, as a rule, twice the thread size. (Example) For M4: L2 = 8  
• Applicable shaft types: S, W

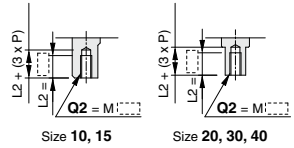

Size	Q2
10	M3
15	M3, M4
20	M3, M4
30	M3, M4, M5
40	M4, M5, M6

**Symbol: A3**

The long shaft can be further shortened by machining male threads into it.  
(If shortening the shaft is not required, indicate "\*" for dimension X.)  
• Applicable shaft types: S, W

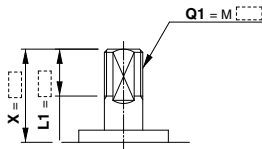

Size	X	L1 max	Q1
10	9 to 18	X - 4	M5
15	10 to 20	X - 4	M6

**Symbol: A4**

The short shaft can be further shortened by machining male threads into it.  
(If shortening the shaft is not required, indicate "\*" for dimension Y.)  
• Applicable shaft type: W

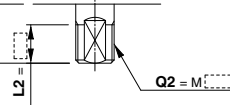

Size	Y	L2 max	Q2
10	7 to 9	Y - 2	M5
15	8 to 10	Y - 3	M6

**Symbol: A5**

The long shaft can be further shortened by machining it into a stepped round shaft.  
(If shortening the shaft is not required, indicate "\*" for dimension X.)  
(If not specifying dimension C1, indicate "\*" instead.)  
• Applicable shaft types: S, W  
• Equal dimensions are indicated by the same marker.

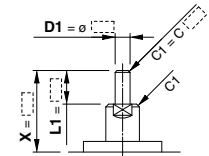

Size	X	L1 max	D1
10	3 to 18	X - 2	ø3.5 to ø4.9
15	3 to 20	X - 2	ø3.5 to ø5.9

**Symbol: A6**

The short shaft can be further shortened by machining it into a stepped round shaft.  
(If shortening the shaft is not required, indicate "\*" for dimension Y.)  
(If not specifying dimension C2, indicate "\*" instead.)  
• Applicable shaft type: W  
• Equal dimensions are indicated by the same marker.

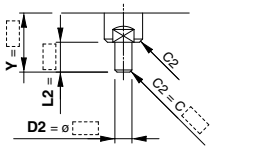

Size	Y	L2 max	D2
10	1 to 9	Y	ø3.5 to ø4.9
15	1 to 10	Y	ø3.5 to ø5.9

**Symbol: A7**

The long shaft can be further shortened by machining it into a stepped round shaft with male threads.  
(If shortening the shaft is not required, indicate "\*" for dimension X.)  
(If not specifying dimension C1, indicate "\*" instead.)  
• Applicable shaft types: S, W

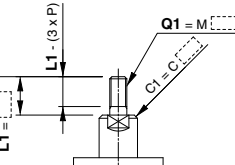

Size	X	L1 max	Q1
10	8 to 18	X - 2	M3, M4
15	9.5 to 20	X - 2	M3, M4, M5

**Symbol: A8**

The short shaft can be further shortened by machining it into a stepped round shaft with male threads.  
(If shortening the shaft is not required, indicate "\*" for dimension Y.)  
(If not specifying dimension C2, indicate "\*" instead.)  
• Applicable shaft type: W

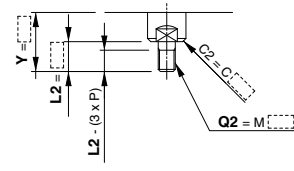

Size	Y	L2 max	Q2
10	6 to 9	Y	M3, M4
15	7.5 to 10	Y	M3, M4, M5

## Shaft Pattern Sequencing I

Symbol  
-XA9 to XA16

### Additional Reminders

1. Enter the dimensions within a range that allows for additional machining.
2. Unless indicated otherwise, the dimensional tolerance conforms to the general tolerance. SMC will make appropriate arrangements.
3. The length of the unthreaded portion is 2 to 3 pitches.
4. Unless specified otherwise, the thread pitch is based on coarse metric threads.  
M3 x 0.5, M4 x 0.7, M5 x 0.8  
M6 x 1
5. Enter the desired figures in the  portion of the diagram.
6. XA9 to XA24 are the standard products that have been additionally machined.
7. Chamfer face of the parts machining additionally is C0.5.

### Symbol: A9

The long shaft can be further shortened by changing the length of the standard chamfer on the long shaft side.  
(If shortening the shaft is not required, indicate "\*" for dimension X.)

- Applicable shaft types: S, W

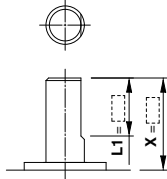

Size	X	L1
10	8 to 18	$\{10 - (18 - X)\}$ to $\{X - 2\}$
15	10 to 20	$\{10 - (20 - X)\}$ to $\{X - 2\}$

### Symbol: A10

The short shaft can be further shortened by changing the length of the standard chamfer.  
(If shortening the shaft is not required, indicate "\*" for dimension Y.)

- Applicable shaft type: W

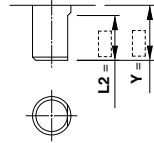

Size	Y	L2
10	3 to 9	$6 - (9 - Y)$ to Y
15	3 to 10	$7 - (10 - Y)$ to Y

### Symbol: A11

The long shaft can be further shortened by machining a double-sided chamfer on it.

- Since L1 is a standard chamfer, dimension E1 is 0.5 or more.

(If altering the standard chamfer and shortening the shaft are not required, indicate "\*" for both the L1 and X dimensions.)

- Applicable shaft types: S, W

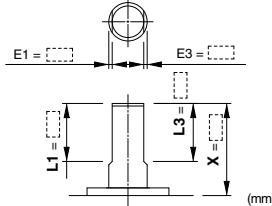

Size	X	L1	L3 max
10	8 to 18	$\{10 - (18 - X)\}$ to $\{X - 2\}$	X - 2
15	10 to 20	$\{10 - (20 - X)\}$ to $\{X - 2\}$	X - 2

### Symbol: A12

The short shaft can be further shortened by machining a double-sided chamfer on it.

- Since L2 is a standard chamfer, dimension E2 is 0.5 or more.

(If altering the standard chamfer and shortening the shaft are not required, indicate "\*" for both the L2 and Y dimensions.)

- Applicable shaft type: W

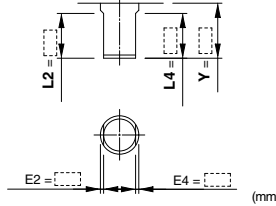

Size	Y	L2	L4 max
10	3 to 9	$6 - (9 - Y)$ to Y	Y
15	3 to 10	$7 - (10 - Y)$ to Y	Y

### Symbol: A13

Shaft with through-hole  
Minimum machining diameter for d1 is 0.1.

- Applicable shaft types: S, W

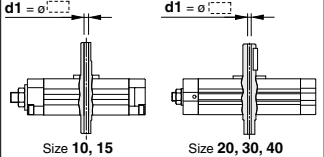

Size	d1
10	ø2 to ø3
15	ø2 to ø4
20	ø2.5 to ø3.5
30	ø3 to ø5.5
40	ø4 to ø7

### Symbol: A14

A special end is machined onto the long shaft, and a through-hole is drilled into it. Female threads are machined into the through-hole, whose diameter is equivalent to the pilot hole diameter.

- The maximum dimension L1 is, as a rule, twice the thread size.

- (Example) For M3: L1 = 6

- Applicable shaft types: S, W

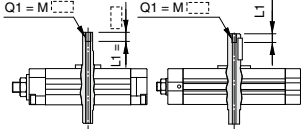

Size	10	15	20	30	40
Thread					
M3 x 0.5	ø2.5	ø2.5	ø2.5	—	—
M4 x 0.7	—	ø3.3	ø3.3	ø3.3	—
M5 x 0.8	—	—	—	ø4.2	ø4.2
M6 x 1	—	—	—	—	ø5

### Symbol: A15

A special end is machined onto the short shaft, and a through-hole is drilled into it. Female threads are machined into the through-hole, whose diameter is equivalent to the pilot hole diameter.

- The maximum dimension L2 is, as a rule, twice the thread size. (Example) For M4: L2 = 8

- Applicable shaft types: S, W

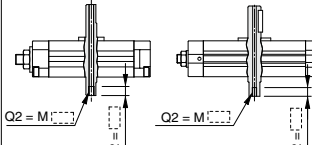

Size	10	15	20	30	40
Thread					
M3 x 0.5	ø2.5	ø2.5	ø2.5	—	—
M4 x 0.7	—	ø3.3	ø3.3	—	—
M5 x 0.8	—	—	—	ø4.2	ø4.2
M6 x 1	—	—	—	—	ø5

### Symbol: A16

A special end is machined onto both the long and short shafts, and a through-hole is drilled into both shafts. Female threads are machined into the through-holes, whose diameter is equivalent to the diameter of the pilot holes.

- The maximum dimension L1 is, as a rule, twice the thread size. (Example) For M5: L1 = 10

- Applicable shaft types: S, W

- Equal dimensions are indicated by the same marker.

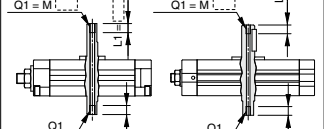

Size	10	15	20	30	40
Thread					
M3 x 0.5	ø2.5	ø2.5	ø2.5	—	—
M4 x 0.7	—	ø3.3	ø3.3	ø3.3	—
M5 x 0.8	—	—	—	ø4.2	ø4.2
M6 x 1	—	—	—	—	ø5

**Shaft Pattern Sequencing I**

Symbol

**-XA17 to XA24**

**Symbol: A17**

Shorten the long shaft.  
 • Applicable shaft types: S, W

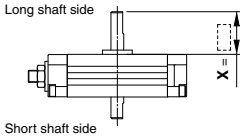

Size	X (mm)
10	2 to 18
15	2 to 20
20	17 to 30
30	18 to 32
40	18.5 to 36

**Symbol: A18**

Shorten the short shaft.  
 • Applicable shaft type: W

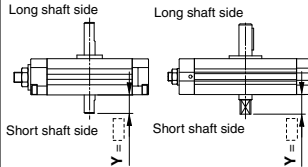

Size	Y (mm)
10	1 to 9
15	1 to 10
20	1 to 15
30	1 to 18
40	1 to 20

**Symbol: A19**

Both the long shaft and short shaft are shortened.  
 • Applicable shaft type: W

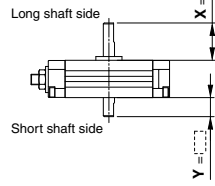

Size	X (mm)	Y (mm)
10	2 to 18	1 to 9
15	2 to 20	1 to 10
20	17 to 30	1 to 15
30	18 to 32	1 to 18
40	18.5 to 36	1 to 20

**Symbol: A20**

Reverse the assembly of the shaft. (Thus shortening the long end and the short end of the shaft.)  
 (If shortening the shaft is not required, indicate "\*" for dimension X and Y.)

• Applicable shaft types: S, W

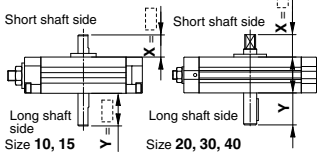

Size	X (mm)	Y (mm)
10	2 to 10	1 to 17
15	2 to 11	1 to 19
20	2.5 to 16.5	1.6 to 28.5
30	3 to 20	1.6 to 30
40	3 to 22	1.6 to 34

**Symbol: A21**

The long shaft can be further shortened by machining it into a stepped round shaft with a double-sided chamfer. (If shortening the shaft is not required, indicate "\*" for dimension X.) (If not specifying dimension C1, indicate "\*" instead.)

• Applicable shaft types: S, W  
 • Equal dimensions are indicated by the same marker.

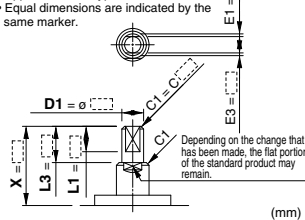

Size	X	L1 max	L3	D1
10	5 to 18	X - 3.5	L1 + 1.5	ø3.5 to ø4.9
15	5.5 to 20	X - 4	L1 + 2	ø3.5 to ø5.9

**Symbol: A22**

The short shaft can be further shortened by machining it into a stepped round shaft with a double-sided chamfer. (If shortening the shaft is not required, indicate "\*" for dimension Y.) (If not specifying dimension C2, indicate "\*" instead.)

• Applicable shaft type: W  
 • Equal dimensions are indicated by the same marker.

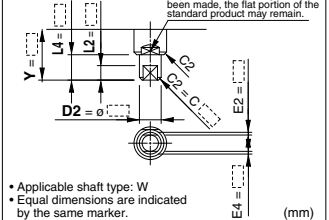

Size	Y	L2 max	L4	D2
10	3 to 9	Y - 1.5	L2 + 1.5	ø3.5 to ø4.9
15	3.5 to 10	Y - 2	L2 + 2	ø3.5 to ø5.9

**Symbol: A23**

The long shaft can be further shortened by machining right-angle double-sided chamfer onto it.

• Since L1 is a standard chamfer, dimension E1 is 0.5 or more. (If altering the standard chamfer and shortening the shaft are not required, indicate "\*" for both the L1 and X dimensions.)  
 • Applicable shaft types: S, W

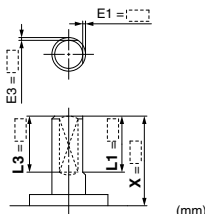

Size	X	L1	L3 max
10	8 to 18	{10 - (18 - X)} to {X - 2}	X - 2
15	10 to 20	{10 - (20 - X)} to {X - 2}	X - 2

**Symbol: A24**

Double key  
 Keys and keyways are machined at 180° in the standard position.

• Applicable shaft types: S, W  
 • Equal dimensions are indicated by the same marker.

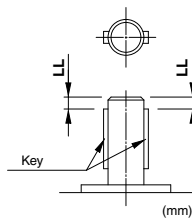

Size	Key dimensions	LL
20	4 x 4 x 20	3
30	4 x 4 x 20	4
40	5 x 5 x 25	5

# CRQ2X Series (Size: 10, 15, 20, 30, 40)

## Simple Specials:

### -XA31 to -XA59: Shaft Pattern Sequencing II

Shaft shape pattern is dealt with through the Simple Specials System.  
Please contact your local sales representative for more details.

Symbol

**-XA31 to XA59**

#### Shaft Pattern Sequencing II

Applicable shaft type: X, Y, Z, T, J and K

#### How to Order

**C** **D** **RQ2XB** **T** **P** **20** **90** **M9BW** **X** **A34** **A37** **C12** **-X6**

##### Built-in magnet

NII	None
D	Built-in magnet

##### Shaft type

X	Single shaft with four chamfers
Y	Double shaft key
Z	Double shaft with four chamfers
T	Single round shaft
J	Double shaft
K	Double round shaft

\* Refer to pages 392 and 393 for the shaft type variations.

##### Size

10
15
20
30
40

##### Auto switch

Refer to page 384 for "How to Order" products with auto switches.

##### Rotating angle

90	80° to 100°
180	170° to 190°

##### Symbol for simple specials, Made-to-Order products

- When number of combinations is 1 or 2, refer to chart 3 and 4.
- Combination of XA is possible for up to 2 types.
- Combination of -X6 (shaft, parallel key stainless steel spec) is available for all the types.

##### Combination 3 Types

A33	A34	C12
A34	A37	-X 6
A35	C 7	C12
A40	C 8	-X 6

##### Combination of Applicable Chart

Chart 3, 4
Chart 3
Chart 4, 5
Chart 4, 5

Combination is available only when all the conditions are fulfilled among the nation chart above.

##### Combination 4 Types

A33	A34	C 7	C12
A34	A37	C12	-X 6
A43	C 7	C11	-X 6

##### Combination of Applicable Chart

Chart 3, 4, 5
Chart 3, 4
Chart 4, 5

Combination is available only when all the conditions are fulfilled among the nation chart above.

\*Combination of simple specials and Made-to-Order, it is possible for up to 4 types.

##### Pattern

##### How to order model with auto switches

Refer to page 384 for "How to Order" products with auto switches.

##### Thread type

Size	Port type	
10, 15	NII	M5
20, 30, 40	NII	Rc 1/8
	TF	G 1/8
	TN	NPT 1/8
	TT	NPTF 1/8



## Shaft Pattern Sequencing II

Symbol  
-XA31 to XA38

### Additional Reminders

1. Enter the dimensions within a range that allows for additional machining.
2. Unless indicated otherwise, the dimensional tolerance conforms to the general tolerance. SMC will make appropriate arrangements.
3. The length of the unthreaded portion is 2 to 3 pitches.
4. Unless specified otherwise, the thread pitch is based on coarse metric threads.  
M3 x 0.5, M4 x 0.7, M5 x 0.8  
M6 x 1
5. Enter the desired figures in the  portion of the diagram.
6. XA31 to XA59 are the standard products that have been additionally machined.
7. Chamfer face of the parts machining additionally is C0.5.

### Symbol: A31

Machine female threads into the long shaft.  
 • The maximum dimension L1 is, as a rule, twice the thread size.  
 (Example) For M3: L1 = 6  
 • Applicable shaft type: Y

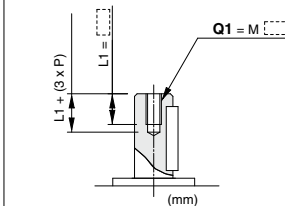

Size	Q1
20	M3, M4
30	M3, M4, M5
40	M4, M5, M6

### Symbol: A32

Machine female threads into the short shaft.  
 • The maximum dimension L2 is, as a rule, twice the thread size.  
 (Example) For M4: L2 = 8  
 • Applicable shaft type: Y

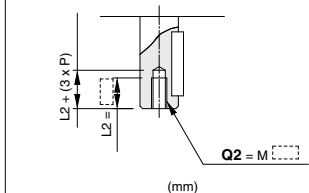

Size	Q2
20	M3, M4
30	M3, M4, M5
40	M4, M5, M6

### Symbol: A33

Machine female threads into the long shaft.  
 • The maximum dimension L1 is, as a rule, twice the thread size.  
 (Example) For M3: L1 = 6  
 • Applicable shaft types: J, K, T

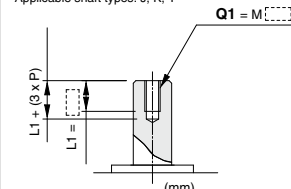

Size	Q1
10	M3
15	M3, M4
20	M3, M4, M5, M6
30	M4, M5, M6, M8
40	M4, M5, M6, M8, M10

### Symbol: A34

Machine female threads into the short shaft.  
 • The maximum dimension L2 is, as a rule, twice the thread size.  
 (Example) For M5: L2 = 10  
 • Applicable shaft types: K, T, X

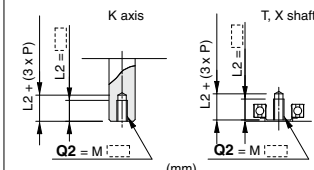

Size	Q2
10	M3
15	M3, M4
20	M3, M4, M5, M6
30	M4, M5, M6, M8
40	M4, M5, M6, M8, M10

### Symbol: A35

Machine female threads into the long shaft.  
 • The maximum dimension L1 is, as a rule, twice the thread size.  
 (Example) For M3: L1 = 6  
 • Applicable shaft types: X, Z

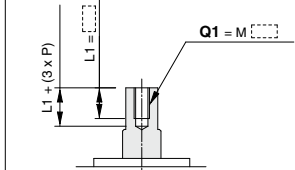

Size	Q1
20	M3, M4
30	M3, M4, M5, M6
40	M4, M5, M6, M8

### Symbol: A36

Machine female threads into the short shaft.  
 • The maximum dimension L2 is, as a rule, twice the thread size.  
 (Example) For M4: L2 = 8  
 • Applicable shaft types: J, Z

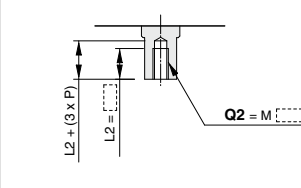

Size	Q2
20	M3, M4
30	M3, M4, M5, M6
40	M4, M5, M6, M8

### Symbol: A37

The long shaft can be further shortened by machining it into a stepped round shaft. (If shortening the shaft is not required, indicate "∞" for dimension X.) (If not specifying dimension C1, indicate "∞" instead.)  
 • Applicable shaft types: J, K, T  
 • Equal dimensions are indicated by the same marker.

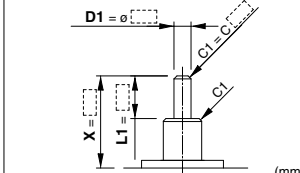

Size	X	L1 max	D1
10	3 to 18	X-2	ø3.5 to ø4.9
15	3 to 20	X-2	ø3.5 to ø5.9
20	3.5 to 30	X-2.5	ø5 to ø9.9
30	4 to 32	X-3	ø5 to ø11.9
40	4 to 36	X-3	ø5 to ø14.9

### Symbol: A38

The short shaft can be further shortened by machining it into a stepped round shaft. (If shortening the shaft is not required, indicate "∞" for dimension Y.) (If not specifying dimension C2, indicate "∞" instead.)  
 • Applicable shaft type: K  
 • Equal dimensions are indicated by the same marker.

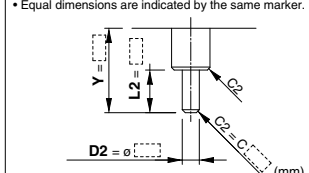

Size	Y	L2 max	D2
10	1 to 18	Y	ø3.5 to ø4.9
15	1 to 20	Y	ø3.5 to ø5.9
20	1 to 30	Y	ø5 to ø9.9
30	1 to 32	Y	ø5 to ø11.9
40	1 to 36	Y	ø5 to ø14.9



Symbol

**-XA39 to XA48**

**Shaft Pattern Sequencing II**

**Symbol: A39**

Shaft with through-hole  
Minimum machining diameter for d1 is 0.1.  
• Applicable shaft type: Y

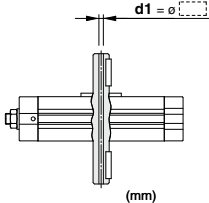

Size	d1
20	ø2.5 to ø3.5
30	ø3 to ø5.5
40	ø4 to ø7

**Symbol: A40**

Shaft with through-hole  
Minimum machining diameter for d1 is 0.1.  
• Applicable shaft types: K, T

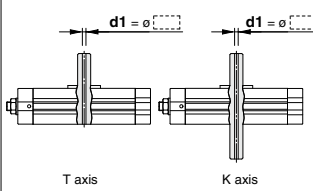

Size	d1
10	ø2 to ø3
15	ø2 to ø4
20	ø2.5 to ø6
30	ø3 to ø8
40	ø4 to ø10

**Symbol: A41**

Shaft with through-hole  
Minimum machining diameter for d1 is 0.1.  
• Applicable shaft types: J, X, Z

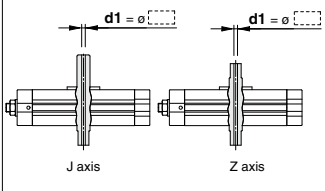

Size	d1
10	ø2 to ø3
15	ø2 to ø4
20	ø2.5 to ø5
30	ø3 to ø7
40	ø4 to ø8

**Symbol: A42**

A special end is machined onto both the long and short shafts, and a through-hole is drilled into both shafts. Female threads are machined into the through-holes, whose diameter is equivalent to the diameter of the pilot holes.

- The maximum dimension L1 is, as a rule, twice the thread size.
- Applicable shaft type: Y
- Equal dimensions are indicated by the same marker.

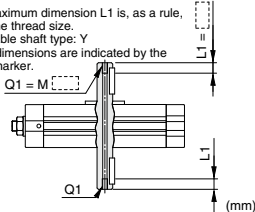

Size	20	30	40
Thread	M3 x 0.5	M4 x 0.7	M5 x 0.8
M3 x 0.5	ø2.5	—	—
M4 x 0.7	ø3.3	ø3.3	—
M5 x 0.8	—	ø4.2	ø4.2
M6 x 1	—	—	ø5

**Symbol: A43**

A special end is machined onto both the long and short shafts, and a through-hole is drilled into both shafts. Female threads are machined into the through-holes, whose diameter is equivalent to the diameter of the pilot holes.

- The maximum dimension L1 is, as a rule, twice the thread size.
- Applicable shaft types: K, T
- Equal dimensions are indicated by the same marker.

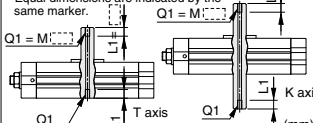

Size	10	15	20	30	40
Thread	M 3 x 0.5	ø2.5	ø2.5	ø2.5	—
M 4 x 0.7	—	ø3.3	ø3.3	ø3.3	—
M 5 x 0.8	—	—	ø4.2	ø4.2	ø4.2
M 6 x 1	—	—	ø5	ø5	ø5
M 8 x 1.25	—	—	—	ø6.8	ø6.8
M10 x 1.5	—	—	—	—	ø8.5
Rc 1/8	—	—	—	—	ø8.2

**Symbol: A44**

A special end is machined onto both the long and short shafts, and a through-hole is drilled into both shafts. Female threads are machined into the through-holes, whose diameter is equivalent to the diameter of the pilot holes.

- The maximum dimension L1 is, as a rule, twice the thread size.
- Applicable shaft types: J, X, Z
- Equal dimensions are indicated by the same marker.

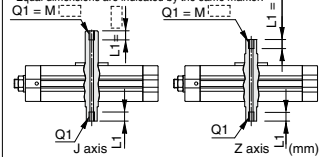

Size	10	15	20	30	40
Thread	M3 x 0.5	ø2.5	ø2.5	ø2.5	—
M4 x 0.7	—	ø3.3	ø3.3	ø3.3	—
M5 x 0.8	—	—	ø4.2	ø4.2	ø4.2
M6 x 1	—	—	—	ø5	ø5
M8 x 1.25	—	—	—	—	ø6.8

**Symbol: A45**

The long shaft can be further shortened by machining a middle-cut chamfer into it. (If shortening the shaft is not required, indicate "s" for dimension X.)

(The position is that of the standard flat at the keyway portion.)

- Applicable shaft types: J, K, T

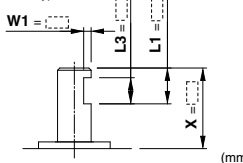

Size	X	W1	L1 max	L3 max
10	6 to 18	0.5 to 1.5	X - 2	L1 - 1
15	6.5 to 20	0.5 to 1.5	X - 2	L1 - 1
20	9.5 to 30	1 to 2	X - 2.5	L1 - 2
30	11.5 to 32	1 to 2	X - 3	L1 - 2
40	12.5 to 36	1 to 2	X - 3	L1 - 2

**Symbol: A46**

The short shaft can be further shortened by machining a middle-cut chamfer into it. (If shortening the shaft is not required, indicate "s" for dimension Y.)

(The position is that of the standard flat at the keyway portion.)

- Applicable shaft type: K

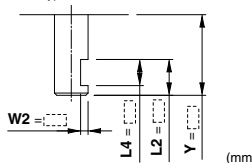

Size	Y	W2	L2 max	L4 max
10	4 to 18	0.5 to 1.5	Y	L2 - 1
15	4.5 to 20	0.5 to 1.5	Y	L2 - 1
20	6.5 to 30	1 to 2	Y	L2 - 2
30	8.5 to 32	1 to 2	Y	L2 - 2
40	9.5 to 36	1 to 2	Y	L2 - 2

**Symbol: A48**

Shorten the long shaft.

- Applicable shaft type: Y

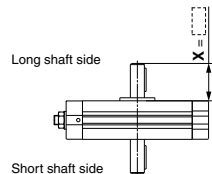

Size	X
20	17 to 30
30	18 to 32
40	18.5 to 36

## Shaft Pattern Sequencing II

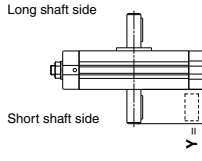
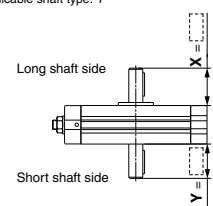
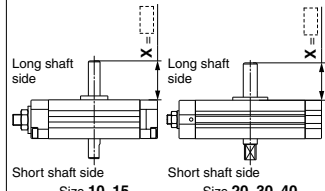
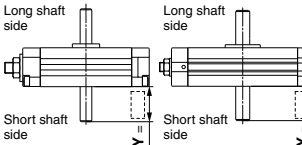
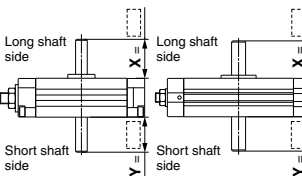
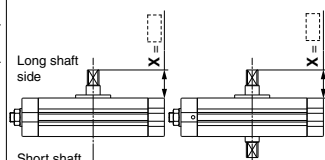
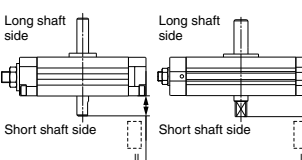
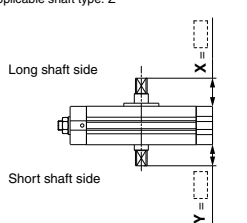
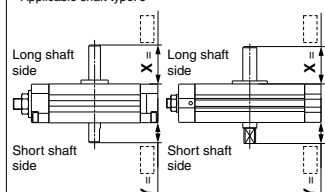
<p><b>Symbol: A49</b></p> <p>Shorten the short shaft. • Applicable shaft type: Y</p>  <p>Long shaft side</p> <p>Short shaft side</p> <p>Size 20, 30, 40</p> <p>(mm)</p> <table border="1"> <thead> <tr> <th>Size</th> <th>Y</th> </tr> </thead> <tbody> <tr> <td>20</td> <td>17 to 30</td> </tr> <tr> <td>30</td> <td>18 to 32</td> </tr> <tr> <td>40</td> <td>18.5 to 36</td> </tr> </tbody> </table>	Size	Y	20	17 to 30	30	18 to 32	40	18.5 to 36	<p><b>Symbol: A50</b></p> <p>Both the long shaft and short shaft are shortened. • Applicable shaft type: Y</p>  <p>Long shaft side</p> <p>Short shaft side</p> <p>Size 20, 30, 40</p> <p>(mm)</p> <table border="1"> <thead> <tr> <th>Size</th> <th>X</th> <th>Y</th> </tr> </thead> <tbody> <tr> <td>20</td> <td>17 to 30</td> <td>17 to 30</td> </tr> <tr> <td>30</td> <td>18 to 32</td> <td>18 to 32</td> </tr> <tr> <td>40</td> <td>18.5 to 36</td> <td>18.5 to 36</td> </tr> </tbody> </table>	Size	X	Y	20	17 to 30	17 to 30	30	18 to 32	18 to 32	40	18.5 to 36	18.5 to 36	<p><b>Symbol: A51</b></p> <p>Shorten the long shaft. • Applicable shaft types: J, K, T</p>  <p>Long shaft side</p> <p>Short shaft side</p> <p>Size 10, 15</p> <p>Long shaft side</p> <p>Short shaft side</p> <p>Size 20, 30, 40</p> <p>(mm)</p> <table border="1"> <thead> <tr> <th>Size</th> <th>X</th> </tr> </thead> <tbody> <tr> <td>10</td> <td>3 to 18</td> </tr> <tr> <td>15</td> <td>3 to 20</td> </tr> <tr> <td>20</td> <td>3.5 to 30</td> </tr> <tr> <td>30</td> <td>4 to 32</td> </tr> <tr> <td>40</td> <td>4 to 36</td> </tr> </tbody> </table>	Size	X	10	3 to 18	15	3 to 20	20	3.5 to 30	30	4 to 32	40	4 to 36										
Size	Y																																											
20	17 to 30																																											
30	18 to 32																																											
40	18.5 to 36																																											
Size	X	Y																																										
20	17 to 30	17 to 30																																										
30	18 to 32	18 to 32																																										
40	18.5 to 36	18.5 to 36																																										
Size	X																																											
10	3 to 18																																											
15	3 to 20																																											
20	3.5 to 30																																											
30	4 to 32																																											
40	4 to 36																																											
<p><b>Symbol: A52</b></p> <p>Shorten the short shaft. • Applicable shaft type: K</p>  <p>Long shaft side</p> <p>Short shaft side</p> <p>Size 10, 15</p> <p>Long shaft side</p> <p>Short shaft side</p> <p>Size 20, 30, 40</p> <p>(mm)</p> <table border="1"> <thead> <tr> <th>Size</th> <th>Y</th> </tr> </thead> <tbody> <tr> <td>10</td> <td>1 to 18</td> </tr> <tr> <td>15</td> <td>1 to 20</td> </tr> <tr> <td>20</td> <td>1 to 30</td> </tr> <tr> <td>30</td> <td>1 to 32</td> </tr> <tr> <td>40</td> <td>1 to 36</td> </tr> </tbody> </table>	Size	Y	10	1 to 18	15	1 to 20	20	1 to 30	30	1 to 32	40	1 to 36	<p><b>Symbol: A53</b></p> <p>Both the long shaft and short shaft are shortened. • Applicable shaft type: K</p>  <p>Long shaft side</p> <p>Short shaft side</p> <p>Size 10, 15</p> <p>Long shaft side</p> <p>Short shaft side</p> <p>Size 20, 30, 40</p> <p>(mm)</p> <table border="1"> <thead> <tr> <th>Size</th> <th>X</th> <th>Y</th> </tr> </thead> <tbody> <tr> <td>10</td> <td>3 to 18</td> <td>1 to 18</td> </tr> <tr> <td>15</td> <td>3 to 20</td> <td>1 to 20</td> </tr> <tr> <td>20</td> <td>3.5 to 30</td> <td>1 to 30</td> </tr> <tr> <td>30</td> <td>4 to 32</td> <td>1 to 32</td> </tr> <tr> <td>40</td> <td>4 to 36</td> <td>1 to 36</td> </tr> </tbody> </table>	Size	X	Y	10	3 to 18	1 to 18	15	3 to 20	1 to 20	20	3.5 to 30	1 to 30	30	4 to 32	1 to 32	40	4 to 36	1 to 36	<p><b>Symbol: A54</b></p> <p>Shorten the long shaft. • Applicable shaft types: X, Z</p>  <p>Long shaft side</p> <p>Short shaft side</p> <p>X axis</p> <p>Long shaft side</p> <p>Short shaft side</p> <p>Z axis</p> <p>(mm)</p> <table border="1"> <thead> <tr> <th>Size</th> <th>X</th> </tr> </thead> <tbody> <tr> <td>20</td> <td>3.5 to 21</td> </tr> <tr> <td>30</td> <td>4 to 24</td> </tr> <tr> <td>40</td> <td>4 to 27</td> </tr> </tbody> </table>	Size	X	20	3.5 to 21	30	4 to 24	40	4 to 27				
Size	Y																																											
10	1 to 18																																											
15	1 to 20																																											
20	1 to 30																																											
30	1 to 32																																											
40	1 to 36																																											
Size	X	Y																																										
10	3 to 18	1 to 18																																										
15	3 to 20	1 to 20																																										
20	3.5 to 30	1 to 30																																										
30	4 to 32	1 to 32																																										
40	4 to 36	1 to 36																																										
Size	X																																											
20	3.5 to 21																																											
30	4 to 24																																											
40	4 to 27																																											
<p><b>Symbol: A55</b></p> <p>Shorten the short shaft. • Applicable shaft type: J, Z</p>  <p>Long shaft side</p> <p>Short shaft side</p> <p>Size 10, 15</p> <p>Long shaft side</p> <p>Short shaft side</p> <p>Size 20, 30, 40</p> <p>(mm)</p> <table border="1"> <thead> <tr> <th>Size</th> <th>Y</th> </tr> </thead> <tbody> <tr> <td>10</td> <td>1 to 9</td> </tr> <tr> <td>15</td> <td>1 to 10</td> </tr> <tr> <td>20</td> <td>1 to 15</td> </tr> <tr> <td>30</td> <td>1 to 18</td> </tr> <tr> <td>40</td> <td>1 to 20</td> </tr> </tbody> </table>	Size	Y	10	1 to 9	15	1 to 10	20	1 to 15	30	1 to 18	40	1 to 20	<p><b>Symbol: A56</b></p> <p>Both the long shaft and short shaft are shortened. • Applicable shaft type: Z</p>  <p>Long shaft side</p> <p>Short shaft side</p> <p>Size 20, 30, 40</p> <p>(mm)</p> <table border="1"> <thead> <tr> <th>Size</th> <th>X</th> <th>Y</th> </tr> </thead> <tbody> <tr> <td>20</td> <td>3.5 to 21</td> <td>1 to 15</td> </tr> <tr> <td>30</td> <td>4 to 24</td> <td>1 to 18</td> </tr> <tr> <td>40</td> <td>4 to 27</td> <td>1 to 20</td> </tr> </tbody> </table>	Size	X	Y	20	3.5 to 21	1 to 15	30	4 to 24	1 to 18	40	4 to 27	1 to 20	<p><b>Symbol: A57</b></p> <p>Both the long shaft and short shaft are shortened. • Applicable shaft type: J</p>  <p>Long shaft side</p> <p>Short shaft side</p> <p>Size 10, 15</p> <p>Long shaft side</p> <p>Short shaft side</p> <p>Size 20, 30, 40</p> <p>(mm)</p> <table border="1"> <thead> <tr> <th>Size</th> <th>X</th> <th>Y</th> </tr> </thead> <tbody> <tr> <td>10</td> <td>3 to 18</td> <td>1 to 9</td> </tr> <tr> <td>15</td> <td>3 to 20</td> <td>1 to 10</td> </tr> <tr> <td>20</td> <td>3.5 to 30</td> <td>1 to 15</td> </tr> <tr> <td>30</td> <td>4 to 32</td> <td>1 to 18</td> </tr> <tr> <td>40</td> <td>4 to 36</td> <td>1 to 20</td> </tr> </tbody> </table>	Size	X	Y	10	3 to 18	1 to 9	15	3 to 20	1 to 10	20	3.5 to 30	1 to 15	30	4 to 32	1 to 18	40	4 to 36	1 to 20
Size	Y																																											
10	1 to 9																																											
15	1 to 10																																											
20	1 to 15																																											
30	1 to 18																																											
40	1 to 20																																											
Size	X	Y																																										
20	3.5 to 21	1 to 15																																										
30	4 to 24	1 to 18																																										
40	4 to 27	1 to 20																																										
Size	X	Y																																										
10	3 to 18	1 to 9																																										
15	3 to 20	1 to 10																																										
20	3.5 to 30	1 to 15																																										
30	4 to 32	1 to 18																																										
40	4 to 36	1 to 20																																										

Symbol

**-XA58 to XA59**

**Shaft Pattern Sequencing II**

**Symbol: A58**

The rotation axis is reversed, and then shorten the long and short shafts.

- Applicable shaft type: J, T

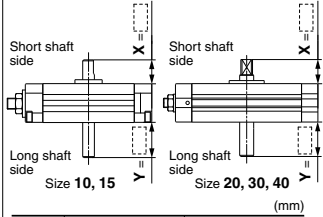

Size	X	Y
10	3 to 10	1 to 17
15	3 to 11	1 to 19
20	3.5 to 16.5	1 to 28.5
30	4 to 20	1 to 30
40	4 to 22	1 to 34

**Symbol: A59**

The rotation axis is reversed, and then shorten the long shaft.

- Applicable shaft type: X

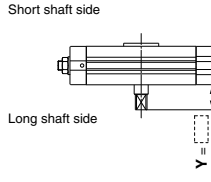

Size	Y
20	1 to 19.5
30	1 to 22
40	1 to 25



## How to Order

**C** **D** **RQ2XB** **S** **P** **20** **90** **M9BW** **X** **A1** **C7** **C12** **-X6**

### Built-in magnet

Nil	None
D	Built-in magnet

### Shaft type

Shaft type variation	Standard	Description
S		Single shaft
W		Double shaft
X		Single shaft with four chamfers
Y		Double shaft key
Z		Double shaft with four chamfers
T		Single round shaft
J		Double shaft
K		Double round shaft

### Size

10
15
20
30
40

### Auto switch

Refer to page 384 for the part no. of auto switches.

### Rotating angle

90	80° to 100°
180	170° to 190°

### Thread type

Size	Port type	
10, 15	Nil	M5
20, 30, 40	Nil	Rc 1/8
	TF	G 1/8
	TN	NPT 1/8
	TT	NPTF 1/8

### Symbol for simple specials, Made-to-Order products

- When number of combinations is 1 or 2, refer to chart 2, 4 and 5.
- Combination of XA is possible for up to 2 types.
- Combination of -X6 (shaft, parallel key stainless steel spec.) is available for all the types.

### Combination 3 Types

**C7** **C12** **-X6**

### Combination of Applicable Chart

Chart 5

Combination is available only when all the conditions are fulfilled among the combination chart above.

### Combination 4 Types

**A1** **C7** **C12** **-X6**

### Combination of Applicable Chart

Chart 2, 5

Combination is available only when all the conditions are fulfilled among the combination chart above.

\* Combination of simple specials and Made-to-Order is available up to 4 types.

### How to order model with auto switches

Refer to page 384 for "How to Order" products with auto switches.

## Combination Chart of Made to Order

Chart 5. Combination between -XC□ and -XC□

Symbol	Description	Applicable size	Combination
<b>XC7</b>	Reversed shaft	10, 15, 20, 30, 40	<b>XC 7</b>
<b>XC8</b> to <b>XC11</b>	Change of rotating range		●
<b>XC12</b> to <b>XC15</b>	Change in angle adjustable range 0° to 100°		●
<b>XC16</b> to <b>XC17</b>	Change in angle adjustable range 90° to 190°		●
<b>XC18</b> to <b>XC19</b>	Change of rotating range		●
<b>XC20</b> to <b>XC21</b>	Change in angle adjustable range 90° to 190°	20, 30, 40	●

**1 Reversed Shaft**

Symbol  
**-XC7**

CRQ2XB  
CDRQ2XB Refer to "How to Order" on page 384. — XC7

Reversed shaft ●

**Specifications**

Applicable size	10, 15, 20, 30, 40
Applicable shaft type	S, W, X, T, J shaft

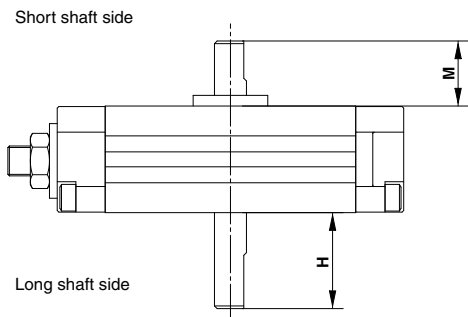

**Size 10, 15**

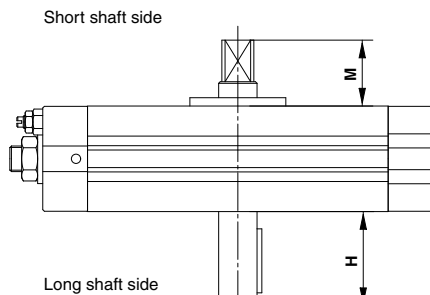

**Size 20, 30, 40**

(mm)

Size	M	H
10	10	17 (—)*
15	11	19 (—)*
20	16.5	28.5 (19.5)*
30	20	30 (22)*
40	22	34 (25)*

\* For X shaft

# CRQ2X Series

## Made to Order Specifications 2

Please contact SMC for detailed dimensions, specifications and lead times.



### 2 Change of Rotating Range

Symbol  
-XC8 to XC11, XC18/XC19

CRQ2XB  
CDRQ2XB Refer to "How to Order" on page 384. —X C8

#### Specifications

Applicable shaft type S, W, Y

Symbol  
-XC8 to XC11, XC18/XC19

#### Additional Reminders

The rotation starting point shows the positions of one flat chamfering and the key groove when pressurized to the connecting port (B).

<p><b>Symbol: C8</b></p> <p>Angle adjustment at the rotation starting point and the end point are at <math>\pm 5^\circ</math>. Rotating range is changed. Rotation angle is at <math>90^\circ \pm 10^\circ</math>. The rotation starting point is on the perpendicular line (down).</p> <p>The figure shows the view from the long shaft end.</p>	<p><b>Symbol: C9</b></p> <p>Angle adjustment at the rotation starting point and the end point are at <math>\pm 5^\circ</math>. Rotating range is changed. Rotation angle is at <math>90^\circ \pm 10^\circ</math>. The rotation starting point is on the horizontal line (left).</p> <p>The figure shows the view from the long shaft end.</p>	<p><b>Symbol: C10</b></p> <p>Angle adjustment at the rotation starting point and the end point are at <math>\pm 5^\circ</math>. Rotating range is changed. Rotation angle is at <math>90^\circ \pm 10^\circ</math>. The rotation starting point is on the perpendicular line (up).</p> <p>The figure shows the view from the long shaft end.</p>								
<p><b>Symbol: C11</b></p> <p>Angle adjustment at the rotation starting point and the end point are at <math>\pm 5^\circ</math>. Rotating range is changed. Rotation angle is at <math>180^\circ \pm 10^\circ</math>. The rotation starting point is on the horizontal line (left).</p> <p>The figure shows the view from the long shaft end.</p>	<p><b>Symbol: C18</b></p> <p>Angle adjustment at the rotation starting point and the end point are at <math>\pm 5^\circ</math>. Rotating range is changed. Rotation angle is at <math>180^\circ \pm 10^\circ</math>. The rotation starting point is on the perpendicular line (down).</p> <p>The figure shows the view from the long shaft end.</p> <table border="1"> <thead> <tr> <th>Operating size</th> </tr> </thead> <tbody> <tr> <td>20</td> </tr> <tr> <td>30</td> </tr> <tr> <td>40</td> </tr> </tbody> </table>	Operating size	20	30	40	<p><b>Symbol: C19</b></p> <p>Angle adjustment at the rotation starting point and the end point are at <math>\pm 5^\circ</math>. Rotating range is changed. Rotation angle is at <math>180^\circ \pm 10^\circ</math>. The rotation starting point is on the perpendicular line (up).</p> <p>The figure shows the view from the long shaft end.</p> <table border="1"> <thead> <tr> <th>Operating size</th> </tr> </thead> <tbody> <tr> <td>20</td> </tr> <tr> <td>30</td> </tr> <tr> <td>40</td> </tr> </tbody> </table>	Operating size	20	30	40
Operating size										
20										
30										
40										
Operating size										
20										
30										
40										

**3 Change of Angle Adjustable Range (0° to 100°, 90° to 190°)** -XC12 to XC17, XC20/XC21

CRQ2XB  
CDRQ2XB Refer to "How to Order" on page 384. —X C12

Symbol  
-XC12 to XC17, XC20/XC21

**Specifications**

Applicable shaft type | S, W, Y, X\*, Z\*, T\*, J\*, K\*

**Additional Reminders**

The rotation starting point is the position of the flat and the key groove when the actuator is pressurized through connection port B.  
\* Only XC12 and XC16 are compatible with shaft types X, Z, T, J and K.

Symbol: **C12**

The rotation angle can be adjusted between 0° and 100°.

Size	Lmax
10	15
15	18
20	24
30	27
40	31.5

The figure shows the view from the long shaft end.

Symbol: **C13**

The rotation angle can be adjusted between 0° and 100°.

Size	Lmax
10	15
15	18
20	24
30	27
40	31.5

The figure shows the view from the long shaft end.

Symbol: **C14**

The rotation angle can be adjusted between 0° and 100°.

Size	Lmax
10	15
15	18
20	24
30	27
40	31.5

The figure shows the view from the long shaft end.

Symbol: **C15**

The rotation angle can be adjusted between 0° and 100°.

Size	Lmax
10	15
15	18
20	24
30	27
40	31.5

The figure shows the view from the long shaft end.

Symbol: **C16**

The rotation angle can be adjusted between 90° and 190°.

Size	Lmax
10	15
15	18
20	24
30	27
40	31.5

The figure shows the view from the long shaft end.

Symbol: **C17**

The rotation angle can be adjusted between 90° and 190°.

Size	Lmax
10	15
15	18
20	24
30	27
40	31.5

The figure shows the view from the long shaft end.

Symbol: **C20**

The rotation angle can be adjusted between 90° and 190°.

Operating size
20
30
40

Size	Lmax
20	24
30	27
40	31.5

The figure shows the view from the long shaft end.

Symbol: **C21**

The rotation angle can be adjusted between 90° and 190°.

Operating size
20
30
40

Size	Lmax
20	24
30	27
40	31.5

The figure shows the view from the long shaft end.

# CRQ2X Series

## Made to Order Specifications 3

Please contact SMC for detailed dimensions, specifications and lead times.



### 4 Shaft, Parallel Key Made of Stainless Steel Spec.

Symbol  
**-X6**

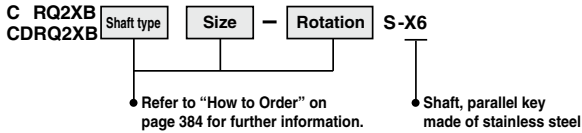

Stainless steel is used as a substitute material for standard parts when used under conditions with a possibility of oxidation or decay.

Fluid	Air (Non-lube)
Applicable shaft type	S, W, X, Y, Z, T, J, K
Applicable size	20, 30, 40
Max. operating pressure	1.0 MPa
Min. operating pressure	0.1 MPa
Cushion	Not attached
Rotation range	80° to 100°, 170° to 190°
Stainless steel part	Shaft, Parallel key
Port size	Rc 1/8, G 1/8, NPT 1/8, NPTF 1/8
Auto switch	Mountable



# Low-Speed Rotary Table Rack & Pinion Type **MSQX Series**

## Size: 10, 20, 30, 50

### How to Order

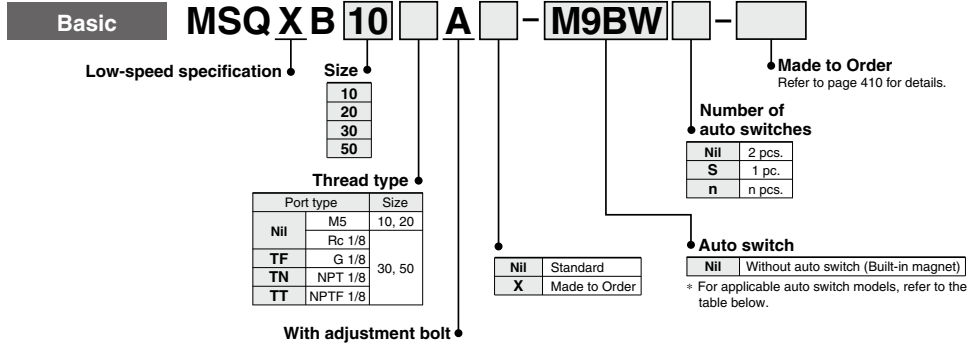

### Applicable Auto Switches

Refer to pages 929 to 983 for detailed auto switch specification.

Type	Special function	Electrical entry	Indicator light	Wiring (Output)	Load voltage		Auto switch model		Lead wire length (m) *				Pre-wired connector	Applicable load			
					DC	AC	Perpendicular	In-line	0.5 (Nil)	1 (M)	3 (L)	5 (Z)					
Solid state auto switch	—	Grommet	Yes	3-wire (NPN)	5 V, 12 V	—	M9NV	M9N	●	●	○	○	—	IC circuit	Relay, PLC		
				3-wire (PNP)			M9PV	M9P	●	●	○	○					
				2-wire	M9BV		M9B	●	●	○	○						
	Diagnostic indication (2-color indicator)			3-wire (NPN)	5 V, 12 V		M9NWW	M9NW	●	●	○	○	—	IC circuit			
				3-wire (PNP)			M9PWW	M9PW	●	●	○	○					
				2-wire	M9BWW		M9BW	●	●	○	○						
	Water resistant (2-color indicator)	3-wire (NPN)	5 V, 12 V	M9NAV <sup>*1</sup>	M9NA <sup>*1</sup>	○	○	○	○	—	IC circuit						
		3-wire (PNP)		M9PAV <sup>*1</sup>	M9PA <sup>*1</sup>	○	○	○	○								
		2-wire	M9BAV <sup>*1</sup>	M9BA <sup>*1</sup>	○	○	○	○									
Reed auto switch	—	Grommet	Yes	3-wire (NPN equiv.)	—	5 V	A96V	A96	●	—	—	—	—	—	IC circuit	—	
				2-wire	24 V	12 V	100 V	A93V <sup>*2</sup>	A93	●	●	●	—	—	—	—	Relay, PLC
							100 V or less	A90V	A90	●	—	—	—	—	—	—	IC circuit

\*1 Although it is possible to mount water resistant type auto switches, note that the rotary actuator itself is not of water resistant construction.

\*2 1 m type lead wire is only applicable to D-A93.

\* Lead wire length symbols: 0.5 m ..... Nil (Example) M9NV  
 1 m ..... M (Example) M9NWM  
 3 m ..... L (Example) M9NWL  
 5 m ..... Z (Example) M9NWZ

\* Auto switches marked with a "○" are produced upon receipt of orders.

\* Refer to pages 970 and 971 for the details of solid state auto switch with pre-wired connector.

\* Auto switches are shipped together, (but not assembled).

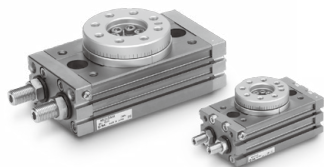

## Specifications

Size	10	20	30	50
<b>Fluid</b>	Air (Non-lube)			
<b>Max. operating pressure</b>	1 MPa			
<b>Min. operating pressure</b>	0.1 MPa			
<b>Ambient and fluid temperature</b>	0° to 60°C (No freezing)			
<b>Cushion</b>	Not attached			
<b>Angle adjustment range</b>	0 to 190°			
<b>Maximum rotation angle</b>	190°			
<b>Port size</b>	<b>End port</b>	M5 x 0.8	Rc 1/8, G 1/8, NPT 1/8, NPTF 1/8	
	<b>Side port</b>	M5 x 0.8		
<b>Output (N·m)*</b>	0.89	1.8	2.7	4.6

\* Output under the operating pressure at 0.5 MPa. Refer to page 381 for further information.

Symbol



### Made to Order

Refer to page 416 for details.

Symbol	Specifications/Content
-X15□	With external stopper

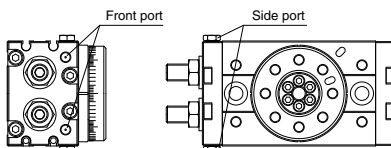

## Allowable Kinetic Energy and Rotation Time Adjustment Range

Size	Allowable kinetic energy (J)	Stable operational rotation time adjustment range (s/90°)
10	0.007	1 to 5
20	0.025	
30	0.048	
50	0.081	

Note) If operated where the kinetic energy exceeds the allowable value, this may cause damage to the internal parts and result in product failure. Please pay special attention to the kinetic energy levels when designing, adjusting and during operation to avoid exceeding the allowable limit.

## Weight

Size	10	20	30	50
Basic	500	940	1230	1990

\* Not including the weight of auto switch.

## Rotation Direction and Rotation Angle

- The rotary table turns in the clockwise direction when the A port is pressurized, and in the counter-clockwise direction when the B port is pressurized.
- By adjusting the adjustment bolt, the rotation end can be set within the range shown in the drawing for the desired rotation angle.

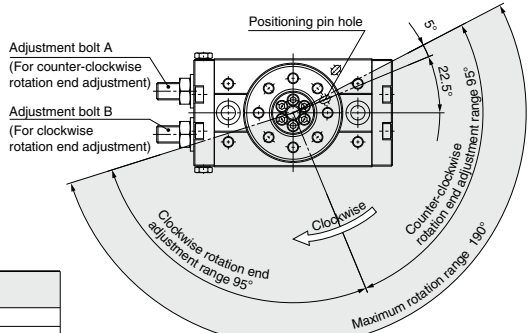
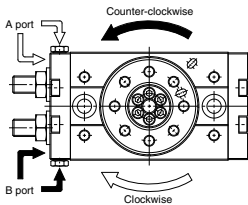

### With Adjustment Bolt

Size	Adjustment angle per rotation of angle adjustment screw
10	10.2°
20	7.2°
30	6.5°
50	8.2°

- Note) • The drawing shows the rotation range of the positioning pin hole.  
• The pin hole position in the drawing shows the counter-clockwise rotation end when the adjustment bolts A and B are tightened equally and the rotation is adjusted 180°.

## Rotation Angle Range Example

- Various rotation ranges are possible as shown in the drawings below using adjustment bolts A and B. (The drawings also show the rotation ranges of the positioning pin hole.)

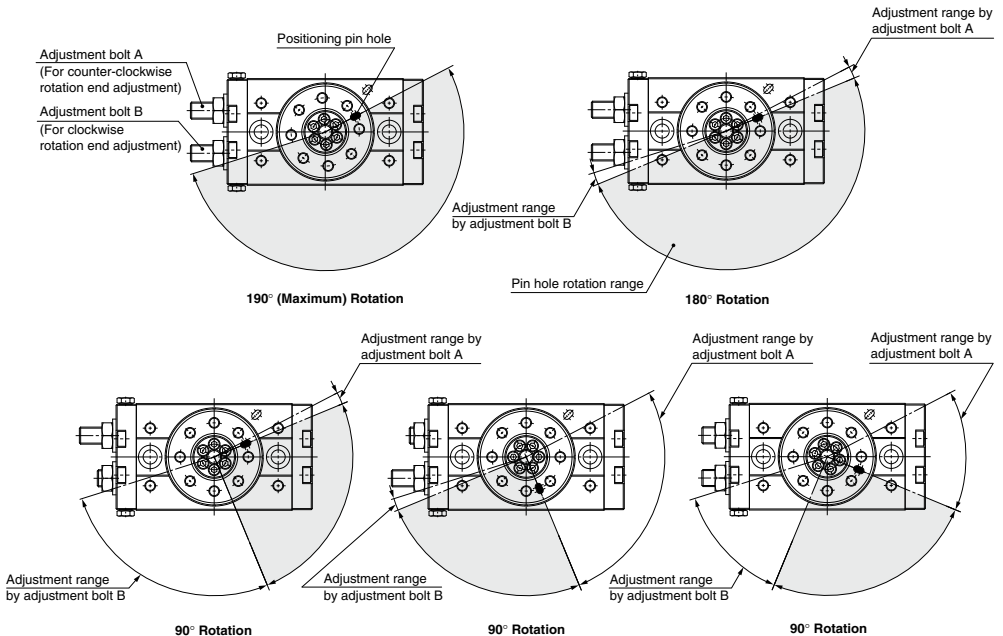

## Table Displacement (Reference values)

- The following graphs show the displacement at point A, which is 100 mm apart from the center of rotation, where the load is applied.

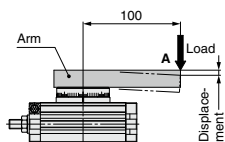

**MSQXB10A**

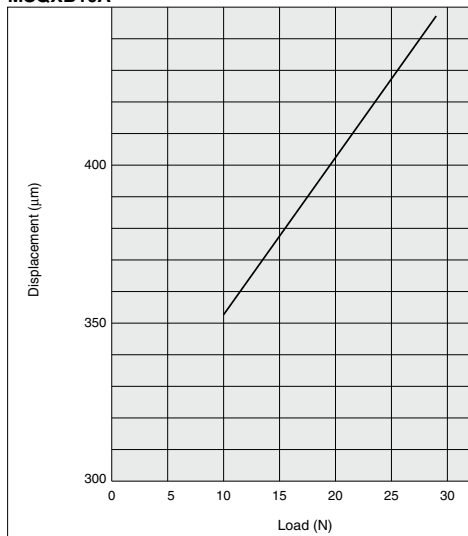

**MSQXB20A**

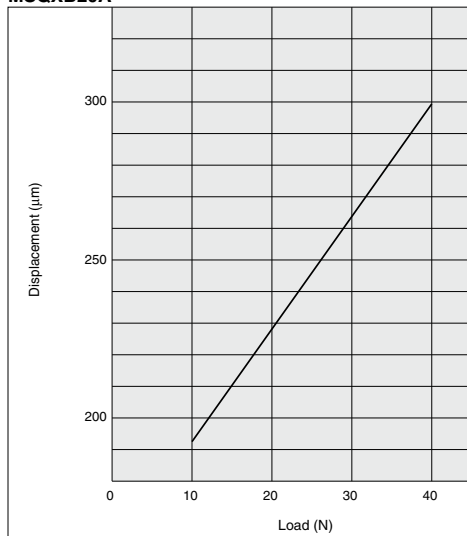

**MSQXB30A**

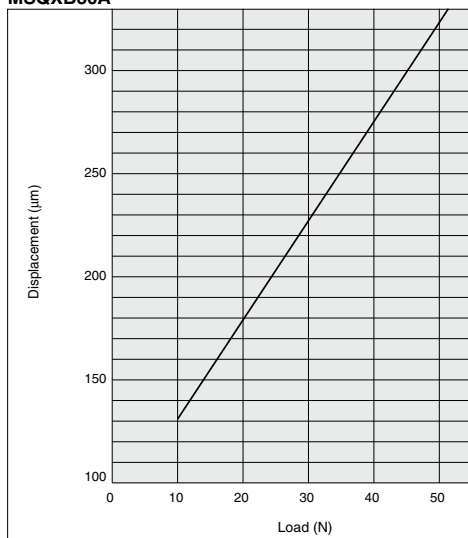

**MSQXB50A**

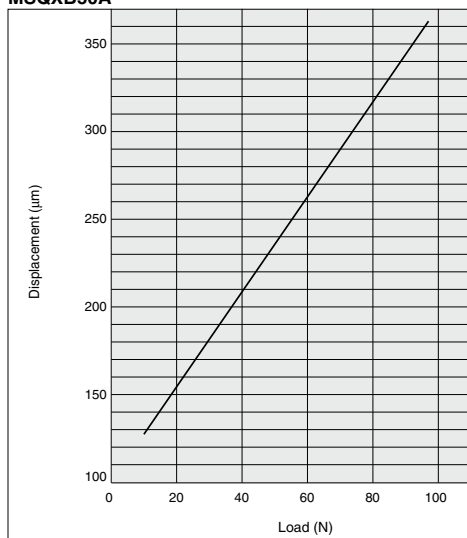

## Construction

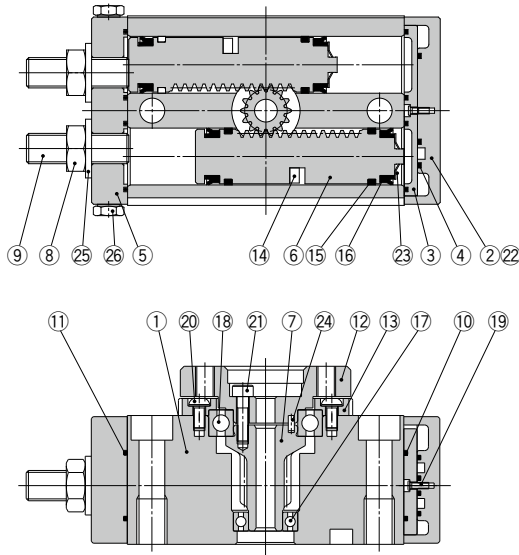

### Component Parts

No.	Description	Material
1	Body	Aluminum alloy
2	Cover	Aluminum alloy
3	Plate	Aluminum alloy
4	Seal	NBR
5	End cover	Aluminum alloy
6	Piston	Stainless steel
7	Pinion	Chrome molybdenum steel
8	Hexagon small nut	Steel wire
9	Adjustment bolt	Chrome molybdenum steel
10	Gasket	NBR
11	Gasket	NBR
12	Table	Aluminum alloy
13	Bearing retainer	Aluminum alloy
14	Magnet	—

\* Individual part cannot be shipped.

### Component Parts

No.	Description	Material	
15	Wear ring	Resin	
16	Piston seal	NBR	
17	Bearing	Bearing steel	
18	Bearing	Bearing steel	
19	Cross recessed screw No. 0	Steel wire	
20	Cross recessed screw	Size: 10	Stainless steel
	Hexagon this socket head bolt	Size: 20 to 50	Chrome molybdenum steel
21	Hexagon socket head cap screw	Stainless steel	
22	Hexagon socket head cap screw	Stainless steel	
23	Push nut	Stainless steel	
24	Parallel pin	Carbon steel	
25	Seal washer	NBR	
26	Plug	Steel wire	

### Replacement Parts

Description	Part no.											
	10			20			30			50		
Seal kit	P523010-20			P523020-20			P523030-20			P523040-20		
	No.	Description	Qty.	No.	Description	Qty.	No.	Description	Qty.	No.	Description	Qty.
Parts included in seal kit	4	Seal	1	4	Seal	1	4	Seal	1	4	Seal	1
	10	Gasket	1	10	Gasket	1	10	Gasket	1	10	Gasket	1
	11	Gasket	1	11	Gasket	1	11	Gasket	1	11	Gasket	1
	15	Wear ring	4	15	Wear ring	4	15	Wear ring	4	15	Wear ring	4
	16	Piston seal	4	16	Piston seal	4	16	Piston seal	4	16	Piston seal	4
	25	Seal washer	2	25	Seal washer	2	25	Seal washer	2	25	Seal washer	2

\* A set includes all parts above.  
A grease pack (10 g) is included. When only a grease pack is needed, order with the following part number.

Replacement parts/Grease pack part no: P523010-21 (10 g)

# MSQX Series

## Dimensions

### Basic: MSQXB□A

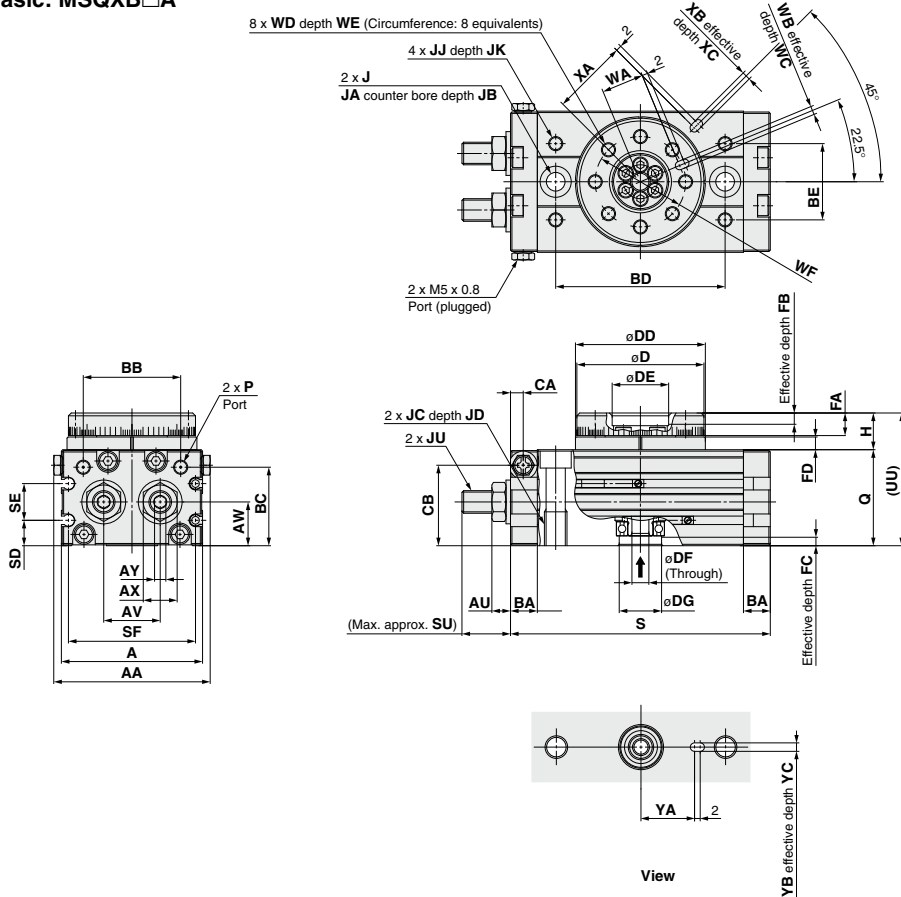

Size	AA	A	AU	AV	AW	AX	AY	BA	BB	BC	BD	BE	CA	CB	D	DD	DE	DF	DG	FA	FB	FC	FD	H	J	JA	JB
10	55.4	50	6.6	20	15.5	12	4	9.5	34.5	27.8	60	27	4.5	28.5	45h9	46h9	20H9	6	15H9	8	4	3	4.5	13	6.8	11	6.5
20	70.8	65	7.6	27.5	16	14	5	12	46	30	76	34	6	30.5	60h9	61h9	28H9	9	17H9	10	6	2.5	6.5	17	8.6	14	8.5
30	75.4	70	7.6	29	18.5	14	5	12	50	32	84	37	6.5	33.5	65h9	67h9	32H9	12	22H9	10	4.5	3	6.5	17	8.6	14	8.5
50	85.4	80	10	38	22	19	6	15.5	63	37.5	100	50	10	37.5	75h9	77h9	35H9	13	26H9	12	5	3	7.5	20	10.5	18	10.5

Size	JC	JD	JJ	JK	JU	P	Q	S	SD	SE	SF	SU	UU	WA	WB	WC	WD	WE	WF	XA	XB	XC	YA	YB	YC
10	M 8 x 1.25	12	M5 x 0.8	7	M 8 x 1	M5 x 0.8	34	92	9	13	45	17.7	47	15	3H9	3.5	M5 x 0.8	8	32	27	3H9	3.5	19	3H9	3.5
20	M10 x 1.5	15	M6 x 1	8	M10 x 1	M5 x 0.8	37	117	10	12	60	25	54	20.5	4H9	4.5	M6 x 1	10	43	36	4H9	4.5	24	4H9	4.5
30	M10 x 1.5	15	M6 x 1	8	M10 x 1	Rc 1/8**	40	127	11.5	14	65	25	57	23	4H9	4.5	M6 x 1	10	48	39	4H9	4.5	28	4H9	4.5
50	M12 x 1.75	18	M8 x 1.25	8	M14 x 1.5	Rc 1/8**	46	152	14.5	15	75	31.4	66	26.5	5H9	5.5	M8 x 1.25	12	55	45	5H9	5.5	33	5H9	5.5

\*\* In addition to Rc 1/8, G 1/8, NPT 1/8 and NPTF 1/8 are also available.

### Auto Switch Proper Mounting Position (at Rotation End Detection)

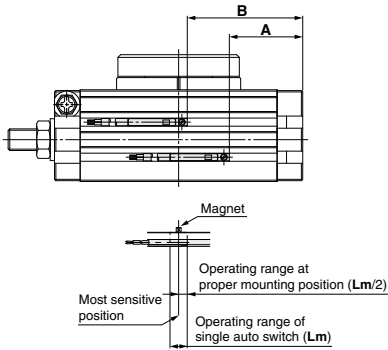

Size	Rotation angle	Reed switch				Solid state switch			
		A	B	Operating angle ( $\theta$ m)	Hysteresis angle	A	B	Operating angle ( $\theta$ m)	Hysteresis angle
10	190°	27	45	90°	10°	31	49	42°	10°
20	190°	35	62	80°	10°	39	66	35°	10°
30	190°	39	68	65°	10°	43	72	30°	10°
50	190°	49	83	50°	10°	53	87	24°	10°

Operating angle  $\theta$ m: Value of the operating range of single auto switch (Lm) as represented by rotation angle for shaft  
Hysteresis angle: Value of the auto switch hysteresis as represented by angle

Note) Since the above values are only provided as a guideline, they are not guaranteed.  
In the actual setting, adjust them after confirming the auto switch operating condition.

Symbol

## With External Stopper

**X150/X151/X152/X153**

Prevent holding torque from being halved at the rotation end.

## How to Order

**MSQXB 10** **AX - M9BW - X150**

Size	Port type		Size
	Port type	Size	
10	Nil	M5	10, 20
20		Rc 1/8	
30	TF	G 1/8	30, 50
50	TN	NPT 1/8	
	TT	NPTF 1/8	

Nil Without auto switch (Built-in magnet)

\* Refer to page 409 for the part no. of auto switches.

Auto switch

• Connection port location and rotation angle

X150	Standard, 180°
X151	Standard, 90°
X152	Symmetric type, 180°
X153	Symmetric type, 90°

## Specifications

Size	10	20	30	50
Rotation angle	90°, 180°			
Angle adjustment range	Each rotation end $\pm 5^\circ$			

\* Specifications other than the above are the same as standard.

## Weight

Size	10	20	30	50
90° spec.	600	1150	1460	2390
180° spec.	570	1090	1390	2280

(g)

\* Values not including the auto switch weight.

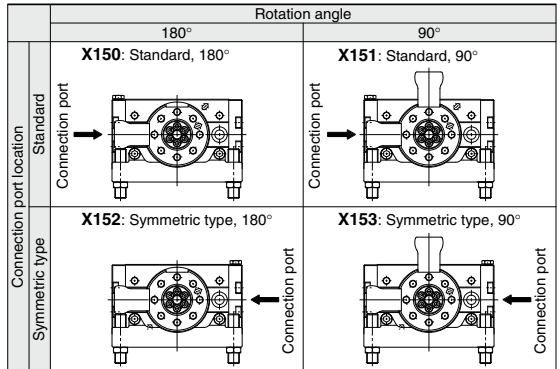

## Dimensions

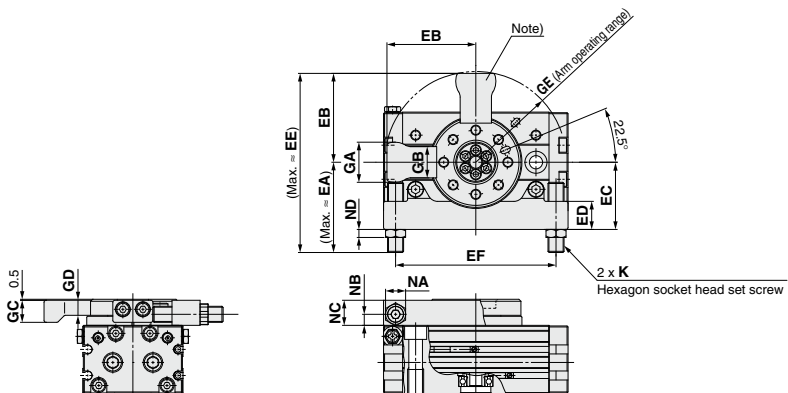

Note) This component does not exist for 180° type.

Size	EA	EB	EC	ED	EE	EF	GA	GB	GC	GD	GE	K	NA	NB	NC	ND
10	47.1	44.3	33.5	14	91.4	80	20	15.6	11	7.5	45.2	M8 x 1	10	5.5	12.5	4
20	57.1	55.3	43	18	112.4	100	25	19.5	14	9.5	56.4	M10 x 1	14	8	16.5	4
30	58.4	60.3	46	19.5	118.7	110	27	21.5	14	9.5	61.5	M10 x 1	14	8	16.5	4
50	74.4	71.4	56	22	145.8	130	32	28	18	11.5	72.9	M14 x 1.5	19	8.5	19.5	6

(mm)

\* Dimensions other than the above are the same as standard.





## CRQ2X/MSQX Series

# Specific Product Precautions

Be sure to read this before handling the products.

For safety instructions as well as rotary actuator and auto switch precautions, refer to the “Handling Precautions for SMC Products” and the “Operation Manual” of each product on the SMC website: <https://www.smcworld.com>

### Selection

#### **Caution**

1. **Changes in speed occur in applications in which there are changes to the load during operation, such as the load being lifted (lowered) against gravity.**
2. **The purpose of this product is stable rotation at low-speed.**  
It does not provide any function to cushion the impact at the operation start or end.
3. **Speed may vary at the rotation end depending on operating conditions. (This phenomenon can be avoided by using the external stopper.)**