

# 3 Position Cylinder

## RZQ Series

ø32, ø40, ø50, ø63

Provides intermediate stop mechanism



- 2-stage stroke enabled with a small increase in length

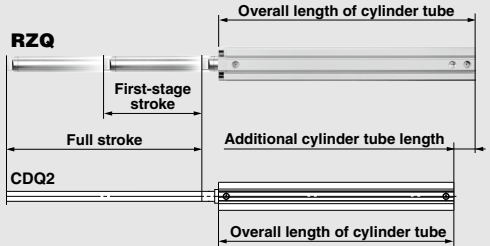

### Comparison of cylinder tube overall length (mm)

Full stroke = 300 mm (150 + 150 = 300 mm in case of CG1BN)

Bore size (mm)	RZQA□-300-150	CDQ2A□-300D	RZQ-CDQ2 Additional cylinder tube length	CG1BN□-150+150-XC11 Dual stroke cylinder
32	382.5	345.5	37	591
40	392	355	37	606
50	396.5	355.5	41	631
63	402	357.5	44.5	631

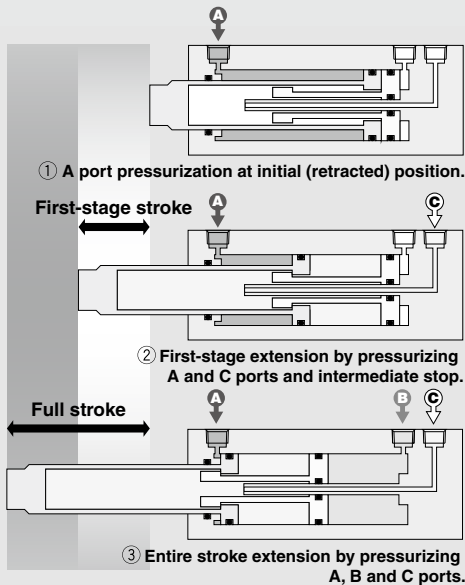

- ◆ **First-stage stroke can be specified without changing the overall length.**
- ◆ **±0.02 mm or less repeatability in intermediate stop positioning**  
High accuracy is achieved by an intermediate stop method of pressing metallic components against each other
- ◆ **First-stage stroke can be freely specified.**  
Full stroke: Available in 25 mm increments, 1 mm increments with a spacer  
First-stage stroke: Available in 1 mm increments
- ◆ **Wide variations in mounting**  
Direct mounting: Mounting taps of the same dimensions as those of the CQ2 series.  
Through holes are also available for full strokes of 75 mm or less.  
Static mounting: Foot type, Rod side flange type  
Rotation bracket: Double clevis

# 3 Position Cylinder

# RZQ Series

ø32, ø40, ø50, ø63

## How to Order

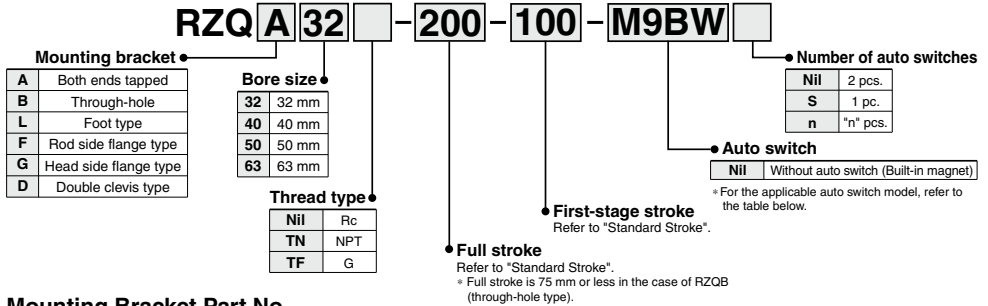

## Mounting Bracket Part No.

Bore size (mm)	Foot <sup>Note 1)</sup>	Flange	Double clevis <sup>Note 2)</sup>
32	RZQ-L032	RZQ-F032	RZQ-D032
40	RZQ-L040	RZQ-F040	RZQ-D040
50	RZQ-L050	RZQ-F050	RZQ-D050
63	RZQ-L063	RZQ-F063	RZQ-D063

Note 1) When ordering foot brackets, order two pieces per cylinder.

Note 2) The following parts are included with each mounting bracket.

Foot, Flange/Body mounting bolts

Double clevis/Clevis pins, type C retaining ring for axis, Body mounting bolts

## Applicable Auto Switches

Refer to pages 1341 to 1435 for detailed auto switch specifications.

Type	Special function	Electrical entry	Indicator light	Wiring (output)	Load voltage		Auto switch model		Lead wire length (m)					Pre-wired connector	Applicable load									
					DC	AC	Perpendicular	In-line	0.5 (Nil)	1 (M)	3 (L)	5 (Z)	None (N)											
																DC	AC	0.5 (Nil)	1 (M)	3 (L)	5 (Z)	None (N)		
Solid state auto switch	—	Grommet	—	3-wire (NPN)	5 V, 12 V	—	M9NV	M9N	●	●	●	○	—	○	IC circuit									
				3-wire (PNP)			M9PV	M9P	●	●	●	○	—	○										
	Diagnostic indication (2-color indicator)	Connector	—	Yes	2-wire	12 V	—	M9BV	M9B	●	●	●	○	—	○	—								
					3-wire (NPN)	5 V, 12 V	—	M9NW	M9NW	●	●	●	○	—	○									
		Grommet	—	Yes	—	3-wire (PNP)	5 V, 12 V	—	M9PW	M9PW	●	●	●	○	—	○	IC circuit							
						2-wire	12 V	—	J79C	—	●	—	●	●	—	—								
						3-wire (NPN)	5 V, 12 V	—	M9NAV <sup>*1</sup>	M9NA <sup>*1</sup>	○	○	●	○	—	○		IC circuit						
						3-wire (PNP)	5 V, 12 V	—	M9PAV <sup>*1</sup>	M9PA <sup>*1</sup>	○	○	●	○	—	○								
						2-wire	12 V	—	M9B <sup>*1</sup>	M9B <sup>*1</sup>	○	○	●	○	—	○		—						
						4-wire	5 V, 12 V	—	—	F79F	●	—	●	○	—	○			IC circuit					
Reed auto switch	—	Grommet	Yes	3-wire (NPN Equiv.)	5 V	—	A96V	A96	●	—	●	—	—	—	IC circuit									
				—	200 V	A72	A72H	●	—	●	—	—	—											
				Connector	—	No	No	2-wire	12 V	100 V	A93V <sup>*2</sup>	A93	●	●	●	—	—	—	Relay, PLC					
									5 V, 12 V	100 V or less	A90V	A90	●	—	●	—	—	—		IC circuit				
									12 V	—	A73C	—	●	—	●	●	—	—						
									5 V, 12 V	24 V or less	A80C	—	●	—	●	●	—	—		IC circuit				
									—	—	A79W	—	●	—	●	—	—	—						
									Grommet	—	No	No	2-wire	24 V	—	—	P4DW	—		—	●	—	—	○
														—	—	—	—	—		—	—	—	—	—

\*1 Water resistant type auto switches can be mounted on the above models, but in such case SMC cannot guarantee water resistance.

Consult with SMC regarding water resistant types with the above model numbers.

\*2 1 m type lead wire is only applicable to D-A93.

\* Lead wire length symbols: 0.5 m ..... Nil (Example) M9NW  
 1 m ..... M (Example) M9NWM  
 3 m ..... L (Example) M9NWL  
 5 m ..... Z (Example) M9NWZ  
 None ..... N (Example) J79CN

\* Auto switches marked with a "○" symbol are produced upon receipt of order.

\* D-P4DW is available in sizes ø40 to ø63.

\* Only D-P4DW type is assembled at the time of shipment.

\* In addition to the models in the above table, there are some other auto switches that are applicable. For more information, refer to page 393.

\* Refer to pages 1410 and 1411 for the details of auto switches with a pre-wired connector.

\* When D-A9□(V)/M9□(V)/M9□(V)/M9□(A)(V) types with ø32 to ø50 are mounted on a side other than the port side, order auto switch mounting brackets separately. Refer to page 393 for details.

## Specifications



Bore size (mm)	32	40	50	63
<b>Action</b>	Double acting, Single rod			
<b>Fluid</b>	Air			
<b>Proof pressure</b>	1.5 MPa			
<b>Maximum operating pressure</b>	1.0 MPa			
<b>Minimum operating pressure</b>	0.1 MPa <sup>Note 1)</sup>			
<b>Ambient and fluid temperature</b>	-10 to 60°C (with no freezing)			
<b>Lubrication</b>	Non-lube			
<b>Operating piston speed</b>	50 to 300 mm/s			
<b>Stroke length tolerance</b>	+1.5 0			
<b>Cushion</b>	Rubber bumper <sup>Note 2)</sup>			
<b>Port size (Rc, NPT, G)</b>	1/8		1/4	

Note 1) When the pressure in A, B and C ports is the same

Note 2) First-stage stroke end (stopping in a intermediate position) without a rubber bumper

## Standard Stroke

<b>Full stroke</b> <sup>Note 1)</sup>	25, 50, 75, 100, 125, 150, 175, 200, 250, 300
<b>First-stage stroke</b> <sup>Note 2)</sup>	5 mm to "Full stroke" -1 mm

Note 1) RZQB (through hole type) is only available for full strokes 25, 50 and 75.

Note 2) Available in 1 mm increments.

Note 3) Be aware of the minimum auto switch mounting stroke (Refer to page 391).

## Manufacture of Intermediate Stroke

<b>Method</b>	Spacers installed in standard stroke body. (Intermediate strokes are compatible with a full stroke only.)
<b>Ordering</b>	Refer to standard part number and ordering on page 382.
<b>How to manufacture</b>	Strokes are available in 1 mm increments by installing spacers in standard stroke cylinders.
<b>Minimum stroke</b>	5 mm
<b>Example</b>	Part no.: RZQA50-135-50 A 15 mm spacer is installed in a standard cylinder RZQA50-150-50. The B dimension is 246.5 mm.

## How to Order Strokes

### RZQA32-150-78

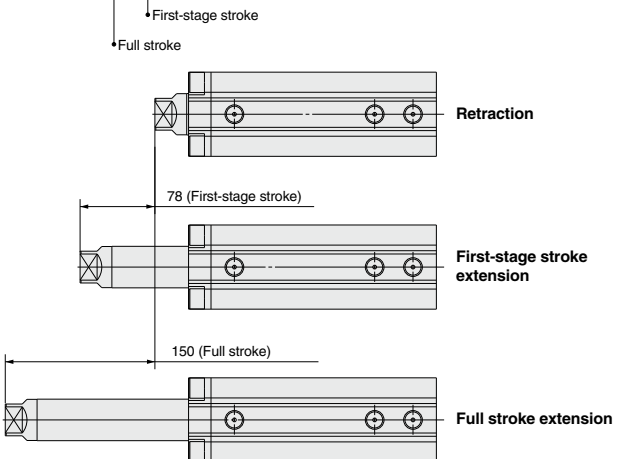

\* Consult with SMC for the special tube for intermediate strokes of a full stroke.

## Theoretical Output

Theoretical Output **Table 1**

[N]

Bore size (mm)	Piston area [mm <sup>2</sup> ]				Air pressure [MPa] (with same air pressure applied to each port)											
	Piston A		Piston B		First stage (Retraction end ↔ Intermediate stop position)						Second stage (Intermediate stop position ↔ Extension end)					
	Front side	Rear side	Front side	Rear side	Extension			Retraction			Extension			Retraction		
	①*	②*	③*	④*	0.3	0.5	0.7	0.3	0.5	0.7	0.3	0.5	0.7	0.3	0.5	0.7
32	410	804	792	792	118	197	276	123	205	287	118	197	276	119	199	279
40	641	1257	1244	1244	185	308	431	192	321	449	185	308	431	188	314	440
50	1001	1963	1935	1935	289	481	673	300	501	701	289	481	673	292	487	681
63	1527	3117	3067	3067	477	795	1113	458	764	1069	477	795	1113	443	739	1034

## Theoretical Output

Action	First stage (Retraction end ↔ Intermediate stop position)			Second stage (Intermediate stop position ↔ Extension end)							
	Extension		Retraction	Extension			Retraction				
Pressure port	A	C	A	A	B	C	A	C			
Air pressure [MPa]	P <sub>A</sub>	P <sub>C</sub>	P <sub>A</sub>	P <sub>A</sub>	P <sub>B</sub> *	P <sub>C</sub> *	P <sub>A</sub>	P <sub>C</sub>			
Formula for theoretical output F [N]	$F = -① \times P_A + ② \times P_C$			$F = ① \times P_A$			$F = -① \times P_A + ④ \times P_B + (② - ③) \times P_C$			$F = ① \times P_A + (③ - ②) \times P_C$	

\* ①, ② and ③ are piston areas. (Refer to **Table 1**.)

\* Assume  $P_B \leq P_C$ .

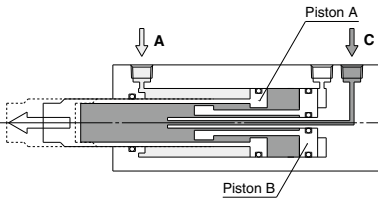

First-stage extension

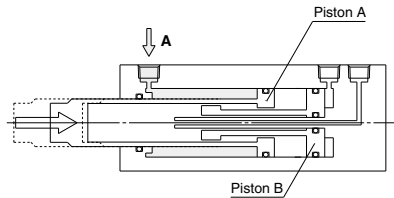

First-stage retraction

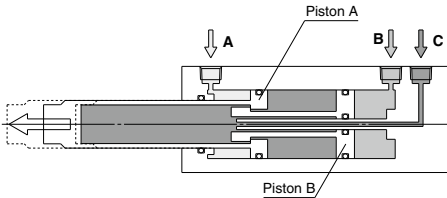

Second-stage extension

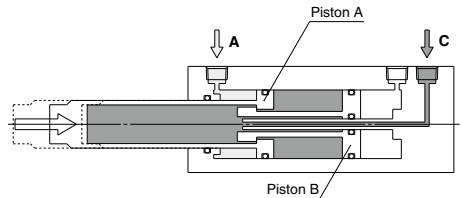

Second-stage retraction

## Weight

### Weight Table

Bore size (mm)	Cylinder stroke									
	25-5	50-5	75-5	100-5	125-5	150-5	175-5	200-5	250-5	300-5
<b>32</b>	0.81	0.88	0.94	1.01	1.07	1.13	1.20	1.26	1.39	1.52
<b>40</b>	1.19	1.27	1.35	1.43	1.50	1.58	1.66	1.73	1.89	2.04
<b>50</b>	1.80	1.92	2.04	2.16	2.28	2.40	2.52	2.64	2.89	3.13
<b>63</b>	2.53	2.71	2.87	3.04	3.20	3.36	3.53	3.69	4.02	4.35

Unit (kg)

Note) Calculate the first-stage stroke referring to the values for "10 mm increase" in the Additional Weight (Table 2) below.

### Additional Weight Table 2

Item	Model	Bore size (mm)			
		32	40	50	63
10 mm increase of first-stage stroke	<b>RZQ□</b>	3	3	6	15
Foot type (including bolts)	<b>RZQL</b>	143	155	243	324
Flange type (including bolts)	<b>RZQG, RZQF</b>	165	198	348	534
Double clevis type (including bolts, pins and retaining ring)	<b>RZQD</b>	151	196	393	554

Unit (g)

Note) Add the Weight in (Table 2) to those in Weight Table.

## RZQB Mounting Bolt

Mounting / Mounting bolts for the through hole type RZQB are available.

Refer to the following for ordering procedures.

Order the actual number of bolts that will be used.

**Example) CQ-M5 x 110L 2 pcs.**

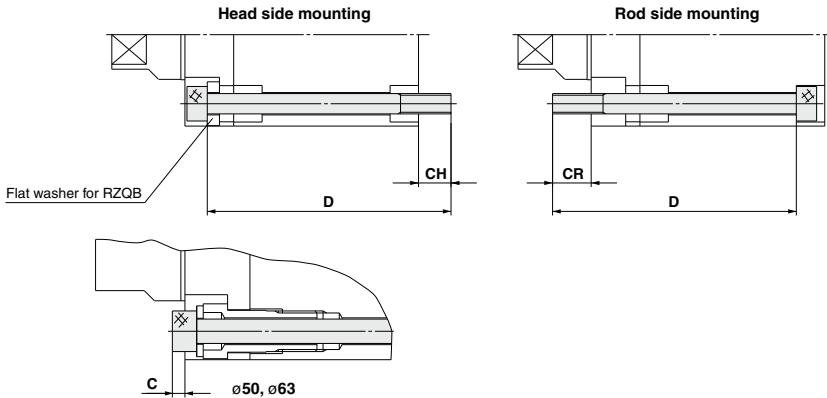

Note) Use the attached washer when inserting the bolt from the rod side.

### RZQB Mounting Bolt

Cylinder model	CH	CR	C	D	Mounting bolt part no.	No. of bolts	Attached flat washer part no.		
<b>RZQB32-25-□</b>	8	9.5	-	110	CQ-M5 x 110L	2 pcs.	RZQ32-12-S7515		
<b>RZQB32-50-□</b>				135	x 135L				
<b>RZQB32-75-□</b>				160	x 160L				
<b>RZQB40-25-□</b>	8.5	10	-	120	CQ-M5 x 120L				
<b>RZQB40-50-□</b>				145	x 145L				
<b>RZQB40-75-□</b>				170	x 170L				
<b>RZQB50-25-□</b>	11.5	16.5	3	130	CQ-M6 x 130L	4 pcs.	Flat washer Nominal size 6		
<b>RZQB50-50-□</b>				155	x 155L				
<b>RZQB50-75-□</b>				180	x 180L				
<b>RZQB63-25-□</b>	12.5	17.5	3.5	135	CQ-M8 x 135L			4 pcs.	Flat washer Nominal size 8
<b>RZQB63-50-□</b>				160	x 160L				
<b>RZQB63-75-□</b>				185	x 185L				

## Model Selection

### Selection chart for pneumatic circuit and selection graph

Select the pneumatic circuit and selection graph according to the following chart.

#### 1) Transfer direction of load

Vertical movement → Horizontal movement → Circuit [A], Graph [1]  
 (= Load is received by guide.)

#### 2) Cylinder orientation

Up → Down → Circuit [A], Graph [2]

#### 3) Cylinder load ratio

0.25 to 0.5 → Less than 0.25 → Circuit [B], Graph [2]

Circuit [C], Graph [1], Minimum load mass = Graph [2]

$$\text{Load ratio} = \frac{W}{\frac{D^2}{4} \cdot \pi \times P_1}$$

W: Load mass [N]  
 D: Cylinder bore size [mm]  
 P<sub>1</sub>: Air pressure (Source pressure) [MPa]

### Selection graph

The optimum size is determined from the intersection of the operating pressure and load mass.

Graph [1]

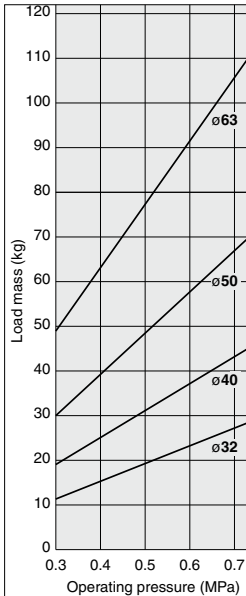

Graph [2]

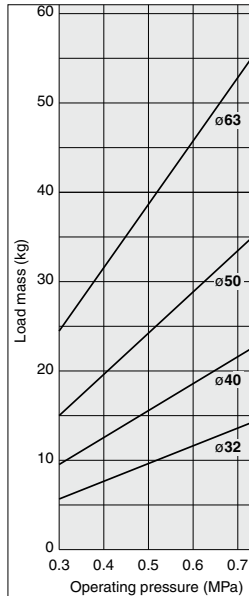

### Selection example

**Selection conditions:** Transfer direction: Vertical movement  
 Cylinder orientation: Down  
 Load mass: 15 kg  
 Operating pressure: 0.4 MPa

→ Circuit [A] and Graph [2] are selected according to the chart.

Find the intersection of an operation pressure of 0.4 MPa and load mass of 15 kg in Graph [2].

→ ø50 is selected.

386

### Pneumatic circuit

#### Circuit [A]

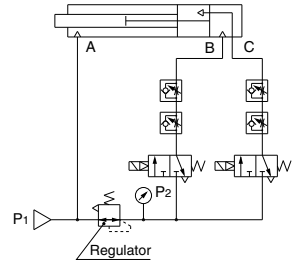

#### Circuit [B]

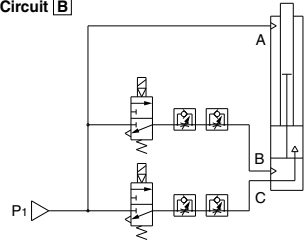

#### Circuit [C]

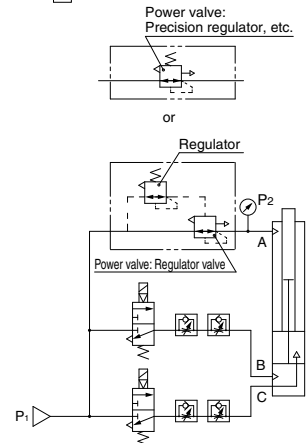

- \* When adjusting the air pressure in A port, use a large exhaust capacity regulator such as a power valve (a regulator valve or precision regulator). Cylinder speed decreases when exhaust capacity is not sufficient.
- \* If A port is open when the cylinder is extended, the operation of piston B may become unstable due to drastic pressure change. Pressure must be constantly applied to A port.

### Confirmation of allowable kinetic energy

Confirm the internal stopper strength at extension and retraction ends in the graph on page 394.

## Pneumatic Circuit Adjustment

### Regulator set pressure

Set the pressures of circuit **A** and circuit **C** regulators at values found by the formula in the following table.

Circuit	Orientation	Bore size (mm)	P <sub>2</sub> [MPa]
<b>A</b>	Horizontal	—	0.75P <sub>1</sub>
<b>A</b>	Down	32	0.75P <sub>1</sub> -0.012m
		40	0.75P <sub>1</sub> -0.0078m
		50	0.75P <sub>1</sub> -0.0050m
		63	0.75P <sub>1</sub> -0.0031m
<b>C</b>	Up	32	1.5P <sub>1</sub> -0.024m
		40	1.5P <sub>1</sub> -0.016m
		50	1.5P <sub>1</sub> -0.010m
		63	1.5P <sub>1</sub> -0.0063m

P<sub>1</sub>: Operating pressure [MPa], m: Load mass [kg]

\* In cases with load fluctuations, substitute the median value of the mass.

Example) Assume circuit **C** with an operating pressure of 0.5 MPa, load mass of 10 kg, fluctuation to 20 kg and a cylinder bore of 32 mm.  
 $\rightarrow P_2 = 1.5 \times 0.5 - 0.024 \times 15 = 0.39 \text{ MPa}$

\* When restarting the regulator after leaving unused for a long period of time, starting pressure increases because rubber sticks to it. Applying the same pressure to P<sub>1</sub> and P<sub>2</sub> is recommended when restarting.

### Speed adjustment

The data below illustrates the strokes controlled by the respective speed controllers. Gradually increase from a low speed to the desired speed setting.

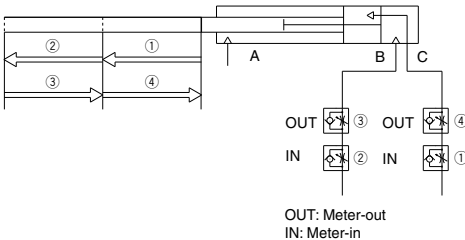

### Overrun at intermediate stop

When stopping at an intermediate point, the cylinder first moves the piston past the intermediate point and then returns it. To confirm this distance of an extra travel (overrun) in Graph **3**, Lines ① to ④ can be selected from the following table.

Circuit	Orientation	Movement	Line
<b>A</b>	Horizontal	Extension	③
		Retraction	④
<b>A</b>	Down	Extension	③
		Retraction	③
<b>B</b>	Up	Extension	①
		Retraction	③
<b>C</b>	Up	Extension	②
		Retraction	④

\* The above values are for cases where the maximum load mass found by the selection method is loaded.

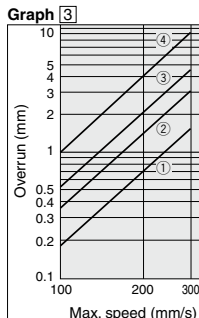

### Change of the return point at the time of power failure

At the time of power failure, circuits **A** to **C** return the piston to the retraction end.

To return the piston to the intermediate point at the time of power failure, add changes to the 3 port valve (Valve 2) on the cylinder rear side so that it will be normally open.

To return the piston to the extension end at the time of power failure, add changes to both 3 port valves so that they will be normally open.

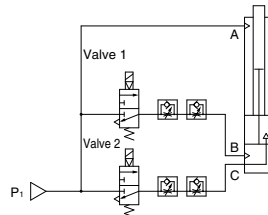

Return to the retraction end when power supply is stopped

Valve 1: Normally closed, Valve 2: Normally closed

Return to the intermediate position when power supply is stopped

Valve 1: Normally closed, Valve 2: Normally open

Return to the extension end when power supply is stopped

Valve 1: Normally open, Valve 2: Normally open

### Change to motion holding circuit

To hold the present motion at the time of power failure instead of performing a return to the specified stop point, change both 3 port valves to 5 port double valves and plug A or B port, whichever is open.

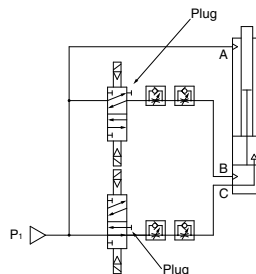

## Construction

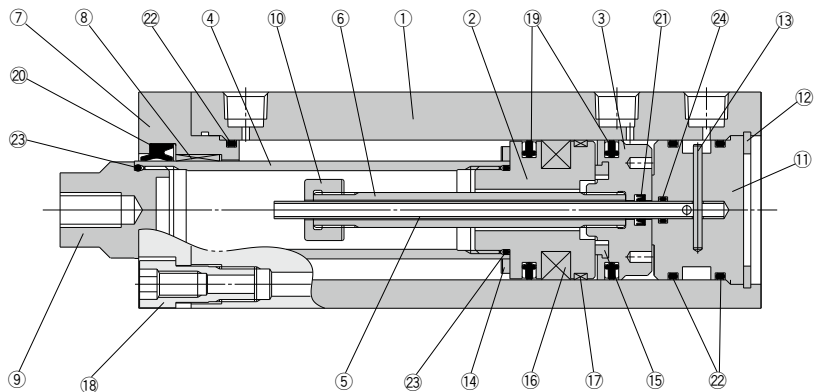

### Component Parts

	Description	Material	Note
1	Cylinder tube	Aluminum alloy	Hard anodized
2	Piston A	Aluminum alloy	
3	Piston B	Aluminum alloy	
4	Tube rod	Carbon steel	Hard chrome plated
5	Inner pipe	Stainless steel	
6	Outer pipe	Carbon steel	Zinc chromated
7	Rod cover	Aluminum alloy	White hard anodized
8	Bushing	Special friction lining	
9	Tube rod cover	Carbon steel	Electroless nickel plated
10	Nut	Carbon steel	Zinc chromated
11	Head cover	Aluminum alloy	Chromated
12	Retaining ring	Carbon tool steel	Phosphate coated

	Description	Material	Note
13	Parallel pin	Carbon steel	
14	Bumper A	Polyurethane	
15	Bumper B	Polyurethane	
16	Magnet	—	
17	Wear ring	Resin	
18	Fitting bolt	Carbon steel	Nickel plated
19	Piston seal	NBR	
20	Rod seal A	NBR	
21	Rod seal B	NBR	
22	Gasket A	NBR	
23	Gasket B	NBR	
24	Gasket C	NBR	

### Replacement Parts/Seal Kit

Bore size (mm)	Kit no.	Contents
32	RZQ32-PS	A set of Nos. 19, 20, 21, 22 and 24 from the table above
40	RZQ40-PS	
50	RZQ50-PS	
63	RZQ63-PS	

\* Seal kits are sets consisting of items 19, 20, 21, 22 and 24 and can be ordered using the seal kit number for each cylinder bore size.

\* Since the seal kit does not include a grease pack, order it separately.

Grease pack part no. GR-L-010 (10 g)



**Dimensions**

**Basic type (Double end tapped): RZQA**

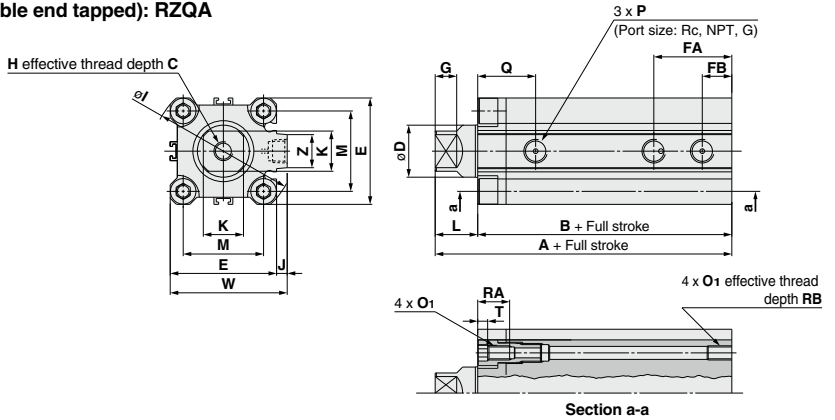

**Basic type (Through-hole): RZQB**

ø32, ø40

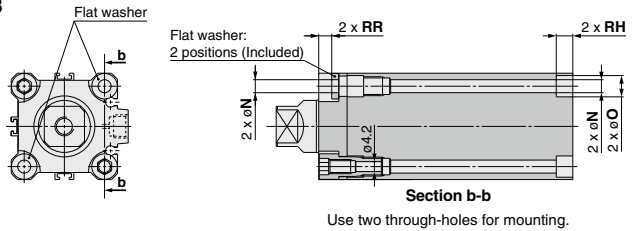

ø63

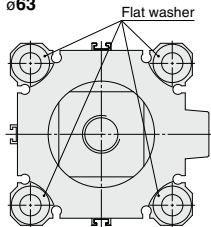

ø50

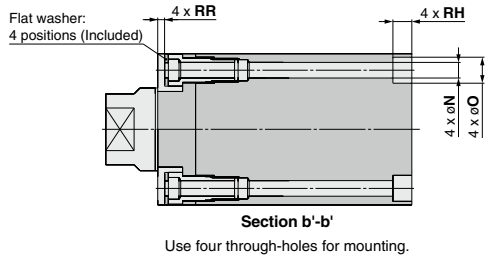
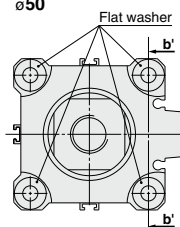

Bore size (mm)	A	B	C	D	E	FA	FB	G	H	I	J	K	L	M	N	O <sub>1</sub>	O	P	Q	RA	RB	RR	RH	T	W	Z
32	100.5	82.5	14	22.4	45	33	12.5	9	M8 x 1.25	60	4.5	17	18	34	5.5	M6 x 1.0	9	Rc 1/8	24.5	14	10	5.5	7	4.5	49.5	14
40	110	92	16	28	52	35	14	9	M10 x 1.5	69	5	24	18	40	5.5	M6 x 1.0	9	Rc 1/8	26	14	10	5.5	7	4.5	57	14
50	118.5	96.5	16	35	64	37	14	12	M10 x 1.5	86	7	30	22	50	6.6	M8 x 1.25	11	Rc 1/4	30	17	14	3	8	5.5	71	19
63	130	102	21	45	77	39.5	16.5	15	M16 x 2.0	103	7	36	28	60	9	M10 x 1.5	14	Rc 1/4	36.5	21.5	18	4.5	10.5	6.5	84	19

# RZQ Series

## Dimensions

### Foot type: RZQL

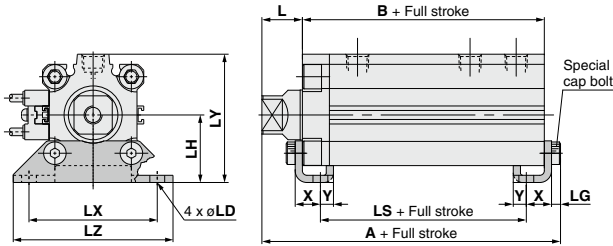

### Foot Type

		(mm)						
Bore size (mm)	A	B	L	LD	LG	LH	LS	
32	107.7	82.5	18	6.6	4	30	66.5	
40	117.2	92	18	6.6	4	33	76	
50	126.7	96.5	22	9	5	39	73.5	
63	138.2	102	28	11	5	46	76	

Bore size (mm)	LX	LY	LZ	X	Y
32	57	57	71	11.2	5.8
40	64	64	78	11.2	7
50	79	78	95	14.7	8
63	95	91.5	113	16.2	9

### Rod side flange type: RZQF

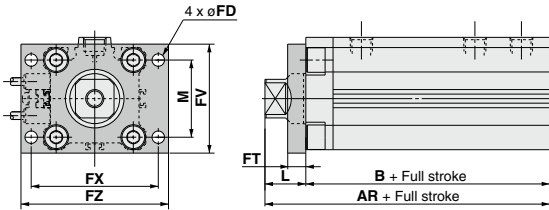

### Flange Type

		(mm)					
Bore size (mm)	AR	AH	B	FD	FT	FV	FX
32	100.5	108.5	82.5	5.5	8	50	56
40	110	118	92	5.5	8	56	62
50	118.5	127.5	96.5	6.6	9	67	76
63	130	139	102	9	9	90	92

### Head side flange type: RZQG

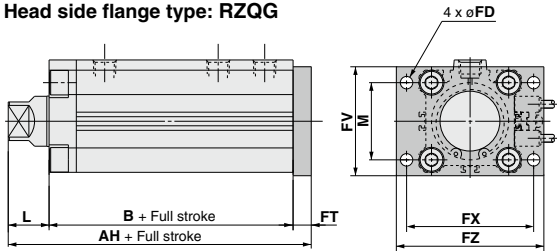

### Bore size (mm)

Bore size (mm)	FZ	L	M
32	65	18	34
40	72	18	40
50	90	22	50
63	108	28	60

### Double clevis type: RZQD

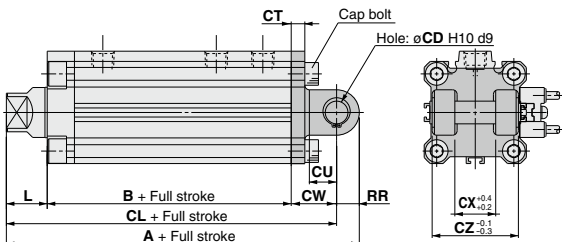

### Double Clevis Type

		(mm)					
Bore size (mm)	A	B	CD	CL	CT	CU	CW
32	130.5	82.5	10	120.5	5	14	20
40	142	92	10	132	6	14	22
50	160.5	96.5	14	146.5	7	20	28
63	174	102	14	160	8	20	30

Bore size (mm)	CX	CZ	L	RR
32	18	36	18	10
40	18	36	18	10
50	22	44	22	14
63	22	44	28	14

# Auto Switch Mounting 1

## Minimum Auto Switch Mounting Stroke

Number of auto switches		(mm)										
		D-M9□V D-F7□V D-J79C	D-A9□V D-A80 D-A73C D-A80C	D-A9□	D-M9□WV D-M9□AV D-F7□WV D-F7BAV	D-A7□H D-A80H	D-M9□ D-F7□ D-J79	D-M9□W D-M9□A	D-A79W	D-F9BA D-F7□W D-J79W D-F7BA D-F79F D-F7NT	D-P4DW	
1 pc.	Full stroke	5	5	10(5)	10	15(5)	15(5)	15(10)	15	20(10)	15	
2 pcs.	Full stroke	5	10	10	15	15(10)	15(5)	15	20	20(15)	15	
3 pcs.	First-stage stroke	5	10	10	15	10	15	15	20	15	15	
	Full stroke – First-stage stroke	5	10	10	15	10	15	15	20	15	15	

Note ) The dimension stated in ( ) shows the minimum stroke for the auto switch mounting when the auto switch does not project from the end surface of the cylinder body and hinder the lead wire bending space. (Refer to the figure below.)  
The auto switch and auto switch mounting bracket are ordered separately.

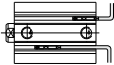

## Auto Switch Proper Mounting Position (Detection of Piston A Stop Position) and Its Mounting Height

- D-A9□
- D-M9□
- D-M9□W
- D-M9□A

- D-A9□V
- D-M9□V
- D-M9□WV
- D-M9□AV

When mounting on the same surface:

Cylinder bore size:  $\phi 32$  to  $\phi 63$

3 auto switches can be mounted on the same surface when the full stroke is 75 mm or longer.

2 auto switches can be mounted on the same surface when the full stroke is less than 75 mm.

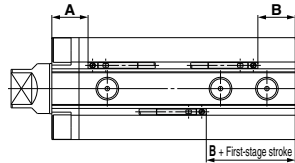
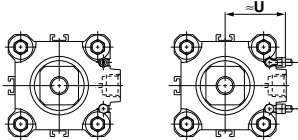

- D-A9□
- D-M9□
- D-M9□W
- D-M9□A

- D-A9□V
- D-M9□V
- D-M9□WV
- D-M9□AV

When mounting on different surfaces:

Auto switches can be mounted on different surfaces when the cylinder bore size is  $\phi 63$ .

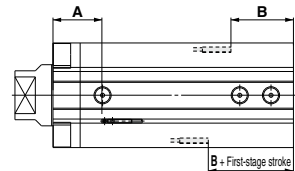
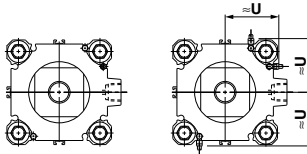

- D-A7□
- D-A80
- D-A7□H
- D-A80H
- D-F7□
- D-J79
- D-F7□W
- D-J79W
- D-F79F

- D-F7NT
- D-F7BA
- D-A73C
- D-A80C
- D-J79C
- D-A79W
- D-F7□WV
- D-F7□V
- D-F7BAV

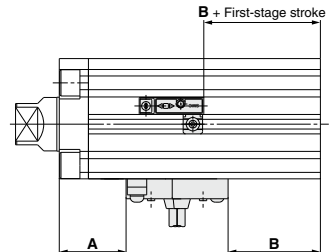
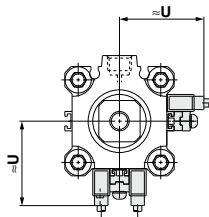

## Auto Switch Proper Mounting Position (Detection of Piston A Stop Position) and Its Mounting Height

ø40, 50, 63

D-P4DW

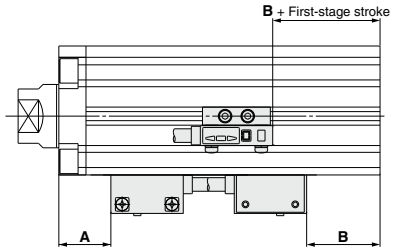
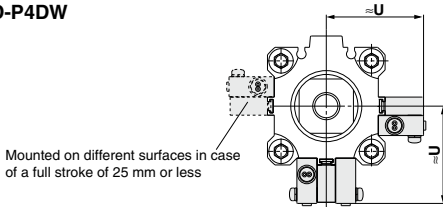

### Auto Switch Proper Mounting Position

\* The values in the table below should be used as a reference for the auto switch mounting position at the stroke end detection. Adjust the auto switch after confirming the operating conditions in the actual setting. (mm)

Auto switch model Bore size	D-A9□ D-A9□V		D-M9□ D-M9□V D-M9□W D-M9□WV D-M9□A D-M9□AV		D-A73 D-A80		D-A72/A7□H D-A80H/A73C D-A80C/F7□J79 D-J79W/F7□V D-J79C/F7□W D-F7□WV/F7BA D-F7BAV/F79F		D-F7NT		D-A79W		D-P4DW	
	A	B	A	B	A	B	A	B	A	B	A	B	A	B
32	26	36.5	30	40.5	27	37.5	27.5	38	32.5	43	24.5	35	—	—
40	30	42	34	46	31	43	31.5	43.5	36.5	48.5	28.5	40.5	27	39
50	32.5	43	36.5	47	33.5	44	34	44.5	39	49.5	31	41.5	29.5	40
63	36	46	40	50	37	47	37.5	47.5	42.5	52.5	34.5	44.5	33	43

### Auto Switch Mounting Height

Auto switch model Bore size	D-A9□V	D-M9□V D-M9□WV D-M9□AV	D-A7□ D-A80	D-A7□H D-A80H D-F7□/F7□F D-J79/J79W D-F7W D-F7BA D-F7NT	D-A73C D-A80C	D-F7□V D-F7□WV D-F7BAV	D-J79C	D-A79W	D-P4DW
	U	U	U	U	U	U	U	U	U
32	27	29	31.5	32.5	38.5	35	38	34	—
40	30.5	32.5	35	36	42	38.5	41.5	37.5	44
50	36.5	38.5	41	42	48	44.5	47.5	43.5	50
63	40	42	47.5	48.5	54.5	51	54	50	56.5

### Operating Range

(mm)

Auto switch model	Bore size			
	32	40	50	63
D-A9□ (V)	9.5	9.5	9.5	11.5
D-M9□ (V) D-M9□W (V) D-M9□A (V)	6	5.5	6	6.5
D-A7□ (H) (C) D-A80□ (H) (C)	12	11	10	12
D-A79W	13	14	14	16
D-F7□ (V) D-J79 (C) D-F7□W (V) D-F7BA (V) D-F7NT D-F79F	6	6	6	6.5
D-P4DW	—	5	5	5

\* Since the operating range is provided as a guideline including hysteresis, it cannot be guaranteed (assuming approximately ±30% dispersion). It may vary substantially depending on an ambient environment.

\* The values above for a bore size over ø32 of D-A9□ (V)/M9□ (V)/M9□A (V) types are measured when the current switch installation groove is attached without using the auto switch mounting bracket BQ2-012.

# Auto Switch Mounting 2

## Auto Switch Mounting Bracket: Part No.

Auto switch mounting surface	Bore size (mm)	
	ø32, ø40, ø50	ø63
Auto switch model	Auto switch mounting surface	Auto switch mounting surface
	Port side	Port, A, B, C side
<b>D-A9□</b> <b>D-A9□V</b> <b>D-M9□</b> <b>D-M9□V</b> <b>D-M9□WV</b> <b>D-M9□A</b> <b>D-M9□AV</b>	Auto Switch mounting brackets are not required.  	Auto Switch mounting brackets are not required.

Note 1) When a compact auto switch is mounted on the three sides (A, B and C above) other than the port side of bore sizes ø32 to ø50, the auto switch mounting brackets above are required. Order them separately from cylinders.  
(It is the same as when mounting compact cylinders with an auto switch mounting rail, but not with ø63 compact auto switch installation groove.)  
Ordering example:  
RZQA32-200-100-M9BW.....1 unit  
BQ-2.....2 pcs.  
BQ2-012.....2 pcs.

Note 2) Auto switches are shipped together with cylinders.

Auto switch model	Bore size (mm)			
	32	40	50	63
<b>D-A7□/A80</b> <b>D-A73C/A80C</b> <b>D-A7□H/A80H</b> <b>D-A79W</b> <b>D-F7□/J79</b> <b>D-F7□V</b> <b>D-J79C</b> <b>D-F7□W/J79W</b> <b>D-F7□WV</b> <b>D-F7BA/F7BAV</b> <b>D-F79F/F7NT</b>	BQ-2			
<b>D-P4DWL</b>	—	BQP1-050		

Note 3) Auto switch mounting brackets and auto switches are shipped together with cylinders. However, ø40 to ø63 of D-P4DW type are assembled at the time of shipment.

### [Mounting screw set made of stainless steel]

The following set of mounting screws made of stainless steel (including nuts) is available. Use it in accordance with the operating environment. (Please order BQ-2 separately, since the auto switch spacer (for BQ-2) is not included.)

BBA2: For D-A7/A8/F7/J7 types

Water resistant auto switch, D-F7BA is set on the cylinder with the stainless steel screws above when shipped. When an auto switch is shipped independently, BBA2 is attached.

Note 4) Refer to page 1443 for the details of BBA2.

Note 5) When mounting D-M9□A (V) on a port other than the ports for ø32, ø40 and ø50, order auto switch mounting brackets BQ2-012S, BQ-2 and stainless steel screw set BBA2 separately.

### Auto Switch Mounting Bracket Weight

Auto switch mounting bracket part no.	Weight (g)
BQ-2	1.5
BQ2-012	5
BQP1-050	16

Other than the applicable auto switches listed in "How to Order" the following auto switches can be mounted.

For detailed specifications, refer to pages 1341 to 1435.

Auto switch type	Part No.	Electrical entry	Features
Reed	D-A73	Grommet (perpendicular)	—
	D-A80		Without indicator light
	D-A73H, A76H	Grommet (in-line)	—
	D-A80H		Without indicator light
Solid state	D-F7NV, F7PV, F7BV	Grommet (perpendicular)	—
	D-F7NWV, F7BWW		Diagnostic indication (2-color indicator)
	D-F7BAV		Water resistant (2-color indicator)
	D-F79, F7P, J79		—
	D-F79W, F7PW, J79W	Grommet (in-line)	Diagnostic indication (2-color indicator)
	D-F7BA		Water resistant (2-color indicator)
	D-F7NT		With timer
	D-P5DW		Magnetic field resistant (2-color indicator)

\* For solid state auto switches, auto switches with a pre-wired connector are also available. Refer to pages 1410 and 1411 for details.

\* Normally closed (NC = b contact) solid state auto switches (D-M9□E(V)) are also available. Refer to page 1360 for details.



# RZQ Series

## Specific Product Precautions

Be sure to read this before handling the products.

Refer to page 9 for safety instructions and pages 10 to 19 for actuator and auto switch precautions.

### Operation

#### ⚠ Caution

- When cylinders are moved from the retraction end to the extension end or from the extension end to the retraction end, they must stop in an intermediate position, even for a moment, and then move to the stroke end.

If the cylinders are moved from the retraction end to the extension end or vice versa without stopping in the intermediate position, the operation of piston B will become unstable and the occurrence of abrasion may be accelerated due to contact with other parts.

### Selection

#### ⚠ Caution

- Keep the relation between the load mass and the maximum speed below the limit lines in Graph (1). If it exceeds the limit line, receive the load with an external stopper.

Operation beyond the limiting lines will cause damage to machinery.

Graph (1)

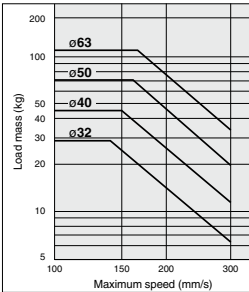

- Use the cylinder in applications in which the overrun will not cause any problem.

When stopping at an intermediate point, this cylinder first moves the piston past the intermediate point and then returns it. Confirm this distance of an extra travel (overrun) in Graph [3] on page 387 and use the cylinder in applications in which the overrun will not cause any problem.

- In cases where a positioning repeatability of 0.1 mm or less is required at the retraction and extension ends, use an external stopper for stops.

Use of an internal stopper will result in approximately 0.1 mm of displacement due to changes in the operating pressure and external forces.

- Use an external guide to receive a moment or torque which can generate a load.

If a moment or torque directly acts on the cylinder, it will lead to reduced service life or damage to machinery.

- To connect a direct acting guide, use floating joints in the following table.

If the direct acting guide is directly connected in operation, it may lead to malfunction or reduced service life.

Model	Applicable floating joint
RZQ□32	JB40-8-125
RZQ□40/50	JB63-10-150
RZQ□63	JB80-16-200

### Selection

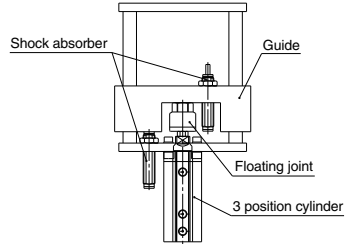

- When the kinetic energy of a load (non-moving parts and moving parts) exceeds the allowable kinetic energy in table 3, it also exceeds the cushioning capacity of the rubber bumper. Add a cushioning mechanism such as a shock absorber shown in the figure above.

Table 3

Bore size (mm)	Allowable kinetic energy (J)
32	0.29
40	0.52
50	0.91
63	1.54

The kinetic energy of a load can be found with the following formula.

$$E = \frac{M + m}{2} v^2$$

E = Kinetic energy (J)

M = Weight of non-moving part (kg)

m = Weight of moving part (kg)

v = Piston speed (m/s)

### Model Selection

#### RZQ Moving Part Weight

Unit (kg)

Bore size (mm)	Cylinder stroke									
	25-5	50-5	75-5	100-5	125-5	150-5	175-5	200-5	250-5	300-5
32	0.18	0.21	0.23	0.26	0.29	0.32	0.34	0.37	0.43	0.48
40	0.31	0.35	0.39	0.43	0.46	0.50	0.54	0.58	0.66	0.74
50	0.58	0.63	0.68	0.73	0.78	0.83	0.88	0.93	1.03	1.13
63	0.73	0.80	0.86	0.93	0.99	1.06	1.12	1.19	1.33	1.45

\* Find the first-stage stroke by adding the weight of an additional 10 mm as in the table below.

#### Additional Weight

Unit (g)

Cylinder bore size (mm)	ø32	ø40	ø50	ø63
First-stage stroke additional 10 mm	3	3	6	15

### Maintenance

#### ⚠ Caution

- If reapplication of grease is needed, apply grease specifically provided for this purpose:

Grease: Product name: Grease pack

Part no.: 10 g GR-L-010

150 g GR-L-150

- When seals are replaced, use a seal kit provided for each bore size.

Dedicated seal kit: Refer to "Construction" on page 388.