

Air Cylinder

CJ2 Series

ø6, ø10, ø16

RoHS

Double foot Head flange
Double-side bossed are
added to the
mounting types.

4 types → 7 types

For ø6, 3 types → 6 types

Improved amount of
mounting freedom

Head cover with
boss is added.

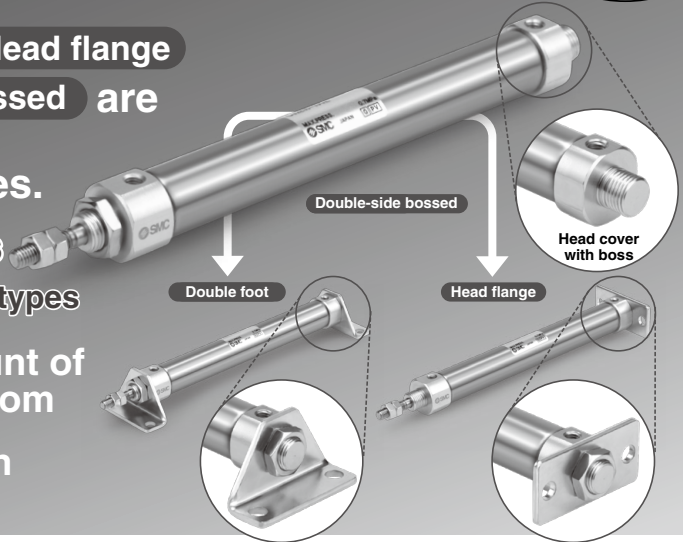

Easy fine adjustment of auto switch position

Fine adjustment of the auto switch position is possible by simply loosening the screw attached to the auto switch.

Transparent switch bracket improves
visibility of indicator LED.

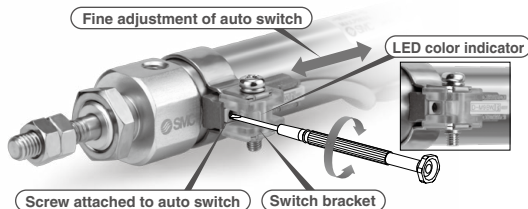

Head cover port location “Perpendicular to axis” is newly added to ø6.

Improved piping flexibility

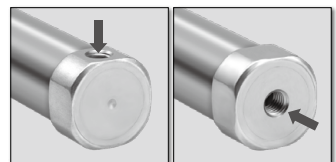

ø6	●	○
ø10	○	○
ø16	○	○



Mounting/Rod end brackets/Accessories (page 91)

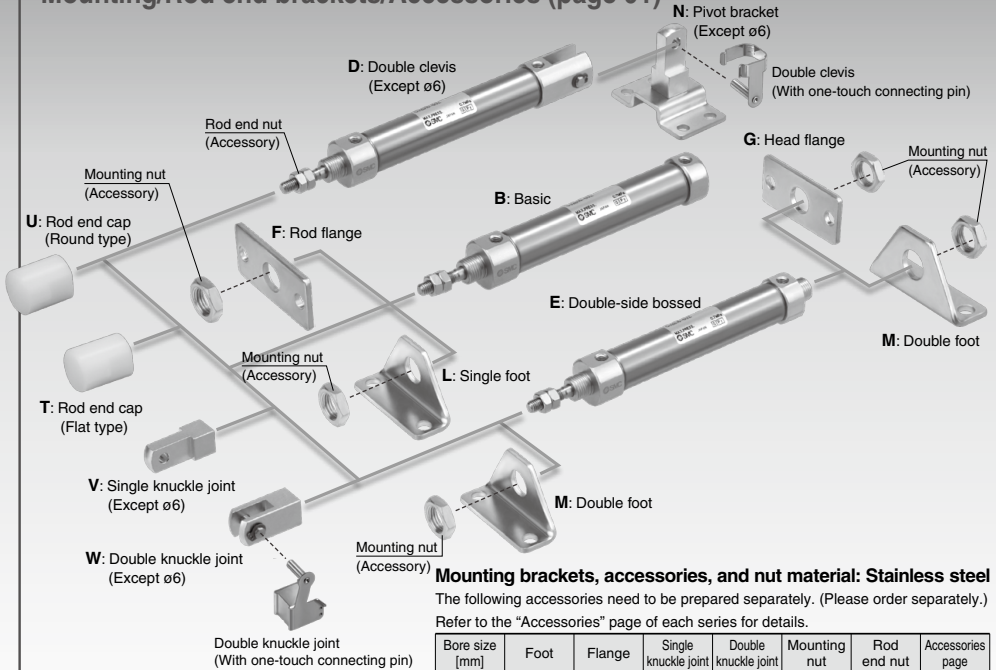

Mounting brackets, accessories, and nut material: Stainless steel

The following accessories need to be prepared separately. (Please order separately.) Refer to the "Accessories" page of each series for details.

Bore size [mm]	Foot	Flange	Single knuckle joint	Double knuckle joint	Mounting nut	Rod end nut	Accessories page
10, 16	○*	○*	○	○	○*	○	p. 92

*: Except bore size 10.

Part numbers with rod end bracket and/or pivot bracket available

Not necessary to order a bracket for the applicable cylinder separately

Note) Mounting bracket is shipped together with the product, but not assembled.

Example) **CDJ2D16-50Z- N W -M9BW-B**

Pivot bracket	
Nil	None
N	Pivot bracket is shipped together with the product, but not assembled.

*: Only for the double clevis type (ø10 and ø16)

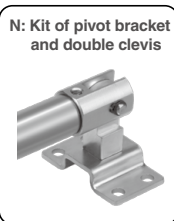

Rod end bracket	
Nil	None
V	Single knuckle joint
W	Double knuckle joint
T	Rod end cap (Flat type)
U	Rod end cap (Round type)

*: V/W: ø10 and ø16 only

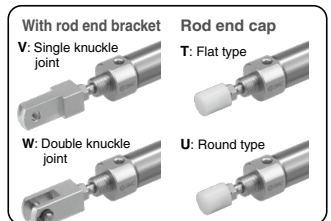

Refer to page 182 for the part number (-X2838) of the double clevis (with one-touch connecting pin).

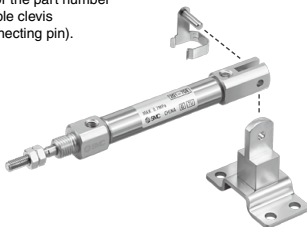

Refer to page 91 for the double knuckle joint (with one-touch connecting pin).

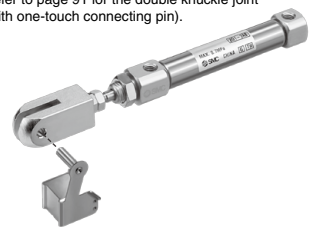

Compact auto switches

General purpose type 2-color indicator Water resistant

Solid state auto switch
D-M9□

Reed state auto switch
D-A9□

In-line electrical entry



Perpendicular electrical entry



Band mounting
(ø6, ø10, ø16)



Rail mounting
(ø10, ø16)

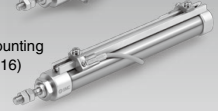

Stroke Variations

Bore size [mm]	Standard stroke									
	15	30	45	60	75	100	125	150	175	200
6	●	●	●	●	●	●	●	●	●	●
10	●	●	●	●	●	●	●	●	●	●
16	●	●	●	●	●	●	●	●	●	●

Series Variations

Series	Action	Type	Bore size [mm]			Variations		Page
			6	10	16	Built-in magnet	Air cushion	
Standard CJ2-Z	Double acting	Single rod	●	●	●	●	●	74
	Double acting	Double rod	●	●	●	●	●	94
	Single acting	Single rod (Spring return /extend)	●	●	●	●	●	101
Non-rotating rod CJ2K-Z	Double acting	Single rod	●	●	●	●	●	118
	Single acting	Single rod (Spring return /extend)	●	●	●	●	●	125
Built-in speed controller CJ2Z-Z	Double acting	Single rod	●	●	●	●	●	137
	Double acting	Double rod	●	●	●	●	●	144
Direct mount CJ2R-Z	Double acting	Single rod	●	●	●	●	●	149
	Single acting	Single rod (Spring return /extend)	●	●	●	●	●	153
Direct mount, Non-rotating rod CJ2RK-Z	Double acting	Single rod	●	●	●	●	●	157
	Single acting	Single rod (Spring return /extend)	●	●	●	●	●	160
With end lock CBJ2	Double acting	Single rod	●	●	●	●	●	164
Smooth Cylinder CJ2Y-Z	Double acting	Single rod	●	●	●	●	●	Web Catalog
Low Speed Cylinder CJ2X-Z	Double acting	Single rod	●	●	●	●	●	Web Catalog

*: The air cylinder with end lock has the same shape as the current product. *: Air cushion is only available for ø10 and ø16.

Environmentally Resistant Specifications

■ Water Resistant ■ Corrosion Resistant

Stainless steel cylinder (CJ5 Series) p. 1117

■ Corrosion Resistant

Fluororubber seal (-XC22) p. 1508

■ Temperature Measures

Heat resistant/Cold resistant cylinder (-XB6, -XB7) p. 1428, 1430

Refer to "Operating Environment" in the Actuator Precautions.

Applications Requiring Lateral Load Resistance

For use in applications in which a lateral load exceeding the allowable value is to be applied, consider using a guide cylinder.

CONTENTS

Air Cylinder *CJ2 Series*



■ Air Cylinder: Standard Type Double Acting, Single Rod CJ2 Series	
How to Order	P.74
Specifications	P.75
Construction	P.77
Dimensions	P.78
Dimensions of Accessories (Options)	P.91
Precautions	P.93



■ Air Cylinder: Standard Type Double Acting, Double Rod CJ2W Series	
How to Order	P.94
Specifications	P.95
Construction	P.97
Dimensions	P.98



■ Air Cylinder: Standard Type Single Acting, Spring Return/Extend CJ2 Series	
How to Order	P.101
Specifications	P.102
Construction	P.104
Dimensions	P.105



■ Air Cylinder: Non-rotating Rod Type Double Acting, Single Rod CJ2K Series	
How to Order	P.118
Specifications	P.119
Construction	P.120
Dimensions	P.121



■ Air Cylinder: Non-rotating Rod Type Single Acting, Spring Return/Extend CJ2K Series	
How to Order	P.125
Specifications	P.126
Construction	P.128
Dimensions	P.129



■ Air Cylinder: Built-in Speed Controller Type Double Acting, Single Rod CJ2Z Series	
How to Order	P.137
Specifications	P.138
Construction	P.139
Dimensions	P.140



■ **Air Cylinder: Built-in Speed Controller Type
Double Acting, Double Rod CJ2ZW Series**

How to Order	P.144
Specifications	P.145
Construction	P.146
Dimensions	P.147



■ **Air Cylinder: Direct Mount Type
Double Acting, Single Rod CJ2R Series**

How to Order	P.149
Specifications	P.150
Construction	P.152



■ **Air Cylinder: Direct Mount Type
Single Acting, Spring Return/Extend CJ2R Series**

How to Order	P.153
Specifications	P.154
Construction	P.155
Dimensions	P.156



■ **Air Cylinder: Direct Mount, Non-rotating Rod Type
Double Acting, Single Rod CJ2RK Series**

How to Order	P.157
Specifications	P.158
Construction	P.159
Dimensions	P.159



■ **Air Cylinder: Direct Mount, Non-rotating Rod Type
Single Acting, Spring Return/Extend CJ2RK Series**

How to Order	P.160
Specifications	P.161
Construction	P.162
Dimensions	P.163



■ **Air Cylinder: With End Lock CBJ2 Series**

How to Order	P.164
Specifications	P.165
Construction	P.166
Dimensions	P.167
Specific Product Precautions	P.171

Auto Switch Mounting	P.172
Made to Order: Individual Specifications	P.180
Specific Product Precautions	P.183

Combinations of Standard Products and Made to Order Specifications

CJ2 Series

- : Standard
- ⊙ : Made to Order
- : Special product (Please contact SMC for details.)
- : Not available

Series	CJ2 (Standard type)				CJ2K (Non-rotating rod type)			Page
	Double acting		Single acting		Double acting	Single acting		
	Single rod	Double rod	Single rod (spring return)	Single rod (spring extend)	Single rod	Single rod (spring return)	Single rod (spring extend)	
	74	94	101		118	125		

Symbol	Specifications	Applicable bore size	ø6 to ø16				ø10, ø16		
Standard	Standard	ø6 to ø16	●	●	●	●	●	●	●
D	Built-in magnet		●	●	●	●	●	●	●
CJ2□-□A	Air cushion	ø10, ø16	●	●	—	—	—	—	—
10-, 11-	Clean series*1	ø6 to ø16	●	●*9	○	○	—	—	—
25A-	Copper (Cu) and Zinc (Zn)-free*5	ø10, ø16	●	○	○	○	○	○	○
XB6	Heat resistant cylinder (-10 to 150°C)*3, 4	ø6 to ø16	⊙	⊙	○	○	○	○	○
XB7	Cold resistant cylinder (-40 to 70°C)*3, 4		⊙	⊙	○	○	○	○	○
XB9	Low speed cylinder (10 to 50 mm/s)*4		⊙	—	—	—	—	—	—
XB13	Low speed cylinder (5 to 50 mm/s)	ø6	⊙	—	—	—	—	—	—
XC3	Special port position*2, 4	ø6 to ø16	⊙	○	—	—	⊙	—	—
XC8	Adjustable stroke cylinder/ Adjustable extension type*4	ø10, ø16	⊙	—	○	○	○	○	○
XC9	Adjustable stroke cylinder/ Adjustable retraction type*4		⊙	—	○	—	⊙	○	—
XC10	Dual stroke cylinder/Double rod type*4		⊙	—	○	○	⊙	○	○
XC11	Dual stroke cylinder/Single rod type*4		⊙	—	—	—	○	—	—
XC22	Fluororubber seal*4	ø6 to ø16	⊙	⊙	⊙	⊙	⊙	○	○
XC51	With hose nipple		⊙	⊙	⊙	⊙	⊙	⊙	⊙
XC85	Grease for food processing equipment		⊙	⊙	⊙	⊙	⊙	⊙	⊙
X446	PTFE grease	ø10, ø16	⊙	⊙	⊙	⊙	⊙	⊙	⊙
X773	Short pitch mounting	ø6	—	—	⊙	—	—	—	—
X2838	Double clevis (With one-touch connecting pin)*11	ø10, ø16	⊙	—	⊙	⊙	⊙	⊙	⊙

*1: Mounting type: Not compatible with the clevis type.
 An auto switch is available in the band mounting type only.
 *2: An auto switch is available in the band mounting type only.
 *3: The products with an auto switch are not compatible.
 *4: The products with an air cushion are not compatible.
 *5: For details, refer to the Web Catalog.

*6: The shape is the same as the current product.
 *7: Available only for locking at head end.
 *8: Available only for locking at rod end.
 *9: ø10 and ø16 only
 *10: Copper and fluorine-free [20-] are available as standard products.
 *11: Not compatible with the air cushion or rail mounting type auto switches.

	CJ2Z (Built-in speed controller type)		CJ2R (Direct mount type)			CJ2RK (Direct mount, Non-rotating rod type)			CBJ2 (With end lock) ^{)*6}	CJ2Y Smooth Cylinder	CJ2X Low Speed Cylinder	Symbol
	Double acting		Double acting	Single acting		Double acting	Single acting		Double acting	Double acting	Double acting	
	Single rod	Double rod	Single rod	Single rod (spring return)	Single rod (spring extend)	Single rod	Single rod (spring return)	Single rod (spring extend)	Single rod	Single rod	Single rod	
	137	144	149	153		157	160		164	Web Catalog	Web Catalog	
	ø10, ø16								ø16	ø10, ø16	ø10, ø16	
	●	●	●	●	●	●	●	●	●	●	●	Standard
	●	●	●	●	●	●	●	●	●	●	●	D
	—	—	○	—	—	—	—	—	—	—	—	CJ2□-□A
	—	—	●	○	○	—	—	—	○*7	—	—	10-, 11-
	○	○	○	○	○	○	○	○	○	○	○	25A-
	○	○	○	○	○	○	○	○	○	—	—	XB6
	○	○	○	○	○	○	○	○	—	—	—	XB7
	—	—	—	—	—	—	—	—	○	—	—	XB9
	—	—	—	—	—	—	—	—	—	—	—	XB13
	—	—	○	—	—	○	—	—	○	◎	○	XC3
	○	—	○	○	○	○	○	○	—	—	—	XC8
	—	—	◎	○	—	◎	○	—	○*8	◎	—	XC9
	○	—	○	○	○	○	○	○	○	○	—	XC10
	—	—	○	—	—	○	—	—	○*8	—	—	XC11
	○	○	◎	○	○	○	○	○	○	—	—	XC22
	◎	◎	◎	◎	◎	◎	◎	◎	—	—	—	XC51
	◎	◎	◎	◎	◎	◎	◎	◎	—	—	—	XC85
	◎	◎	◎	◎	◎	◎	◎	◎	—	—	—	X446
	—	—	—	—	—	—	—	—	—	—	—	X773
	—	—	—	—	—	—	—	—	—	○	○	X2838

Air Cylinder: Standard Type Double Acting, Single Rod

CJ2 Series

ø6, ø10, ø16

RoHS



How to Order

CJ2 **B** **16** - **60** **A** **Z** - [] [] - []

With auto switch

CDJ2 **B** **16** - **60** **A** **Z** - [] [] - **M9BW** [] - **B** - []

With auto switch (Built-in magnet)

1 Mounting

B	Basic
E	Double-side bossed
D**	Double clevis
L	Single foot
M	Double foot
F	Rod flange
G	Head flange

- *: Foot/Flange brackets are shipped together with the product, but not assembled.
- *: Double clevis is only available for ø10 and ø16.
- **: Refer to page 182 for the double clevis (with one-touch connecting pin).

2 Bore size

6	6 mm
10	10 mm
16	16 mm

5 Head cover port location

Nil	Perpendicular to axis	
R	Axial	

- *: For double clevis, the product is perpendicular to the cylinder axis.
- *: For double-side bossed, the product is perpendicular to the cylinder axis.

3 Cylinder standard stroke [mm]

Refer to "Standard Strokes" on page 75.

4 Cushion

Nil	Rubber bumper
A	Air cushion

*: ø6: Rubber bumper only

6 Pivot bracket

Nil	None
N	Pivot bracket is shipped together with the product.

- *: Only for the double clevis type (ø10 and ø16)
- *: Pivot bracket is shipped together with the product, but not assembled.

7 Rod end bracket

Nil	None
V	Single knuckle joint
W**	Double knuckle joint
T	Rod end cap (Flat type)
U	Rod end cap (Round type)

- *: Rod end bracket is shipped together with the product, but not assembled.
- *: Single/Double knuckle joint: ø10 and ø16 only
- **: Refer to page 91 for the double knuckle joint (with one-touch connecting pin).

8 Auto switch

Nil	Without auto switch
------------	---------------------

- *: For applicable auto switches, refer to the table below.
- ★ Enter the auto switch mounting type (A or B) even when a built-in magnet cylinder without an auto switch is required.

9 Number of auto switches

Nil	2 pcs.
S	1 pc.
n	"n" pcs.

10 Auto switch mounting type

A	Rail mounting
B	Band mounting

- *: For rail mounting, screws and nuts for 2 auto switches come with the rail.
- *: Refer to page 178 for auto switch mounting brackets.
- *: ø6: Band mounting only

11 Made to Order

Refer to page 75 for details.

*: Refer to "Ordering Example of Cylinder Assembly" on page 75.

Applicable Auto Switches/Refer to pages 1271 to 1365 for further information on auto switches.

Type	Special function	Electrical entry	Indicator light	Wiring (Output)	Load voltage		Auto switch model				Lead wire length [m]					Pre-wired connector	Applicable load		
					DC	AC	Band mounting		Rail mounting		0.5 (Nil)	1 (M)	3 (L)	5 (Z)	None (N)				
							Perpendicular	In-line	Perpendicular	In-line									
Solid state auto switch	—	Grommet	3-wire (NPN)	5 V, 12 V	—	M9NV	M9N	M9NV	M9N	●	●	●	○	○	IC circuit	Relay, PLC			
						M9PV	M9P	M9PV	M9P	●	●	●	○	○					
	Diagnostic indication (2-color indicator)	Connector	2-wire	12 V	—	M9BV	M9B	M9BV	M9B	●	●	●	○	○	—				
						—	H7C	J79C	—	—	—	●	—	—					
	Water resistant (2-color indicator)	Grommet	3-wire (NPN)	5 V, 12 V	—	M9NVV	M9NV	M9NVV	M9NV	●	●	●	○	○	IC circuit				
						M9PWW	M9PW	M9PWW	M9PW	●	●	●	○	○					
	With diagnostic output (2-color indicator)	Grommet	3-wire (PNP)	24 V	—	M9BWW	M9BW	M9BWW	M9BW	●	●	●	○	○	—				
						M9NAV ^{*1}	M9NA ^{*1}	M9NAV ^{*1}	M9NA ^{*1}	○	○	○	○	○					
	—	Grommet	3-wire (NPN)	5 V, 12 V	—	M9PAV ^{*1}	M9PA ^{*1}	M9PAV ^{*1}	M9PA ^{*1}	○	○	○	○	○	IC circuit				
						M9BAV ^{*1}	M9BA ^{*1}	M9BAV ^{*1}	M9BA ^{*1}	○	○	○	○	○					
—	Grommet	3-wire (NPN equivalent)	5 V, 12 V	—	—	H7NF	—	F79F	●	—	●	○	○	IC circuit					
					—	A96V	A96	A96V	A96	●	—	—	—		—				
Reed auto switch	—	Grommet	2-wire	24 V	—	—	200 V	—	A72	A72H	●	—	—	—	IC circuit	Relay, PLC			
						—	100 V	A93V ^{*2}	A93	A93V ^{*2}	A93	●	●	●			—	—	
						—	100 V or less	A90V	A90	A90V	A90	●	—	—			—	—	
						—	24 V or less	—	C73C	A73C	—	—	●	—			●	●	—
						—	—	—	C80C	A80C	—	—	●	—			●	●	—
						—	—	—	—	A79W	—	—	●	—			●	●	—

*1: Water resistant type auto switches can be mounted on the above models, but in such case SMC cannot guarantee water resistance.

Please contact SMC regarding water resistant types with the above model numbers.

*2: 1 m type lead wire is only applicable to D-A93.

*: Lead wire length symbols: 0.5 m..... Nil (Example) M9NW 5 m..... Z (Example) M9NWZ
 1 m..... M (Example) M9NWM None..... N (Example) H7CN
 3 m..... L (Example) M9NWL

*: Since there are other applicable auto switches than listed above, refer to page 179 for details.

*: Solid state auto switches marked with "○" are produced upon receipt of order.

*: The D-A9□/M9□/A7□/A8□/F7□/J7□ auto switches are shipped together, but not assembled. (For band mounting, only the auto switch mounting brackets are assembled before shipment.)

Air Cylinder: Standard Type Double Acting, Single Rod **CJ2 Series**



Symbol

Rubber bumper

Air cushion

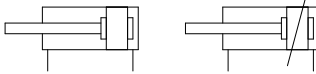

Made to Order: Individual Specifications
(For details, refer to pages 180 and 182.)

Symbol	Specifications
-X446	PTFE grease
-X773 ^{*1}	Short pitch mounting
-X2838 ^{*2}	Double clevis (With one-touch connecting pin)

*1: ø6 only

*2: ø10 and ø16 only

Made to Order

[Click here for details](#)

Symbol	Specifications
-XA <input type="checkbox"/>	Change of rod end shape
-XB6 <input type="checkbox"/>	Heat resistant cylinder (-10 to 150°C) * Not available with switch & with air cushion
-XB7 <input type="checkbox"/>	Cold resistant cylinder (-40 to 70°C) * Not available with switch & with air cushion
-XB9	Low speed cylinder (10 to 50 mm/s) * Not available with air cushion
-XB13 ^{*3}	Low speed cylinder (5 to 50 mm/s) * Not available with air cushion
-XC3	Special port location * Not available with air cushion
-XC8	Adjustable stroke cylinder/Adjustable extension type
-XC9	Adjustable stroke cylinder/Adjustable retraction type
-XC10	Dual stroke cylinder/Double rod type
-XC11	Dual stroke cylinder/Single rod type
-XC22	Fluororubber seal * Not available with air cushion
-XC51	With hose nipple
-XC85	Grease for food processing equipment

*3: ø6 only

Ordering Example of Cylinder Assembly

Cylinder model:

CDJ2D16-60Z-NW-M9BW-B

Double clevis

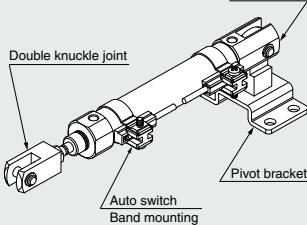

Mounting D: Double clevis
Pivot bracket N: Yes
Rod end bracket W: Double knuckle joint
Auto switch D-M9BW: 2 pcs.
Auto switch mounting B: Band mounting

*: Pivot bracket, double knuckle joint and auto switch are shipped together with the product, but not assembled.

*1: Except ø6

Specifications

Bore size [mm]		6	10	16
Action		Double acting, Single rod		
Fluid		Air		
Proof pressure		1 MPa		
Maximum operating pressure		0.7 MPa		
Minimum operating pressure	Rubber bumper	0.12 MPa	0.06 MPa	0.06 MPa
	Air cushion	—	0.1 MPa	
Ambient and fluid temperature		Without auto switch: -10°C to 70°C (No freezing) With auto switch: -10°C to 60°C		
Cushion		Rubber bumper	Rubber bumper/Air cushion	
Lubrication		Not required (Non-lube)		
Piston speed	Rubber bumper	50 to 750 mm/s		
	Air cushion	—	50 to 1000 mm/s	
Allowable kinetic energy	Rubber bumper	0.012 J	0.035 J	0.090 J
	Air cushion (Effective cushion length)	—	0.07 J (9.4 mm)	0.18 J (9.4 mm)
Stroke length tolerance		+1.0 0		

Standard Strokes

Bore size	Standard stroke	Maximum manufacturable stroke [mm]
6	15, 30, 45, 60	200
10	15, 30, 45, 60, 75, 100, 125, 150	400
16	15, 30, 45, 60, 75, 100, 125, 150, 175, 200	400

*: Manufacture of intermediate strokes in 1 mm increments is possible. (Spacers are not used.)
Produced upon receipt of order.

*: Applicable strokes should be confirmed according to the usage. For details, refer to "Air Cylinders Model Selection" on pages 8 to 19. In addition, the products that exceed the standard stroke might not be able to fulfill the specifications due to the deflection etc.

Mounting and Accessories

Refer to page 68 for the list of brackets and page 91 for details about part numbers and dimensions.

●...Mounted on the product. ○...Can be ordered within the cylinder model. △...Order separately.

	Mounting	Bore size [mm]				
		6	10	16	Double clevis (Note 1)	Double clevis (including T-bracket)
Standard	Mounting nut	●	●	●	—	—
	Rod end nut	●	●	●	●	●
	Clevis pin (including retaining rings)	—	—	—	●	●
	Double clevis (With one-touch connecting pin)	△	△	△	○ (-X2838)	○ (-X2838)
Option	Single knuckle joint	○	○	○	○	○
	Double knuckle joint (including a pin and retaining rings)	○	○	○	○	○
	Double knuckle joint (With one-touch connecting pin)	△	△	△	△	△
	Rod end cap (Flat/Round type)	○	○	○	○	○
	Pivot bracket (T-bracket)	—	—	—	○	●

Note 1) Double clevis is only available for ø10 and ø16.

Note 2) Stainless steel mounting brackets and accessories are also available.

Refer to page 92 for details.

Mounting Brackets/Part No.

Mounting bracket	Bore size [mm]		
	6	10	16
Foot	CJ-L006C	CJ-L010C	CJ-L016C
Flange	CJ-F006C	CJ-F010C	CJ-F016C
T-bracket*	—	CJ-T010C	CJ-T016C

*: T-bracket is used with double clevis (D).

Refer to pages 172 to 179 for cylinders with auto switches.

- Auto switch proper mounting position (detection at stroke end) and its mounting height
- Minimum stroke for auto switch mounting
- Operating range
- Auto switch mounting brackets/Part no.

Moisture Control Tube IDK Series



When operating an actuator with a small diameter and a short stroke at a high frequency, the dew condensation (water droplet) may occur inside the piping depending on the conditions.

Simply connecting the moisture control tube to the actuator will prevent dew condensation from occurring. For details, refer to the [Web Catalog](#).

CJ2 Series

Weights

Bore size [mm]		Rubber bumper			Air cushion	
		6	10	16	10	16
Basic weight (When the stroke is zero)	Basic	20	22	46	39	66
	Axial piping	17	22	46	39	66
	Double clevis (including clevis pin)	—	24	54	43	74
	Head-side bossed	20	23	48	40	68
Additional weight per 15 mm of stroke		2	4	7	4	7
Mounting bracket weight	Single foot	8	8	25	8	25
	Double foot	16	16	50	16	50
	Rod flange	5	5	13	5	13
	Head flange	5	5	13	5	13
Accessories	Clevis pin	—	1	3	1	3
	One-touch connecting pin for double clevis	—	2	4	—	—
	Single knuckle joint	—	17	23	17	23
	Double knuckle joint (including knuckle pin)	—	25	21	25	21
	Double knuckle joint (With one-touch connecting pin)	—	26	22	26	22
	Rod end cap (Flat type)	1	1	2	1	2
	Rod end cap (Round type)	1	1	2	1	2
	Pivot bracket (T-bracket)	—	32	50	32	50



Precautions

Refer to page 183 before handling.

*: Mounting nut and rod end nut are included in the basic weight.

*: Mounting nut is not included in the basic weight for the double clevis.

Calculation:

Example) **CJ2L10-45Z**

- Basic weight 22 (ø10)
 - Additional weight 4/15 stroke
 - Cylinder stroke 45 stroke
 - Mounting bracket weight 8 (Axial foot)
- 22 + 4/15 x 45 + 8 = 42 g

Clean Series

10-CJ2 Mounting 10 - Stroke Head cover port location Z

↓ Clean Series

Air cylinder which is applicable for the system which discharges leakage from the rod section directly into the outside of clean room by relief port and making an actuator's rod section having a double seal construction.



Low Speed Cylinder

CJ2 X Mounting 10 - Stroke Head cover port location Z

↓ Low Speed Cylinder

Smooth operation with a little sticking and slipping at low speed. Can start smoothly with a little ejection even after being rendered for hours.



The dimensions are the same as the double acting, single rod type.

Specifications

Action	Double acting, Single rod	
Bore size [mm]	6, 10, 16	
Maximum operating pressure	0.7 MPa	
Minimum operating pressure	ø6	0.14 MPa
	ø10, ø16	0.08 MPa
Cushion	Rubber bumper/Air cushion	
Standard stroke [mm]	Same as standard type. (Refer to page 75.)	
Auto switch	Mountable (Band mounting)	
Mounting	Basic, Double-side bossed*, Single/Double foot*, Rod/Head flange*	

*: ø10 and ø16 only

Construction

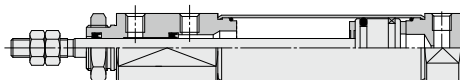

*: The above figure is for ø16.

For the detailed specifications, refer to the **Web Catalog**.

Specifications

Action	Double acting, Single rod	
Bore size [mm]	10, 16	
Fluid	Air	
Proof pressure	1.05 MPa	
Maximum operating pressure	0.7 MPa	
Minimum operating pressure	0.06 MPa	
Ambient and fluid temperature	Without auto switch: -10 to 70°C (No freezing) With auto switch: -10 to 60°C	
Cushion	Rubber bumper (Standard equipment)	
Lubrication	Not required (Non-lube)	
Stroke length tolerance	+1.0 0	
Piston speed	1 to 300 mm/s	
Allowable kinetic energy	ø10	0.035 J
	ø16	0.090 J

For details, refer to the **Web Catalog**.

Construction (Not able to disassemble)

ø6
Rubber bumper

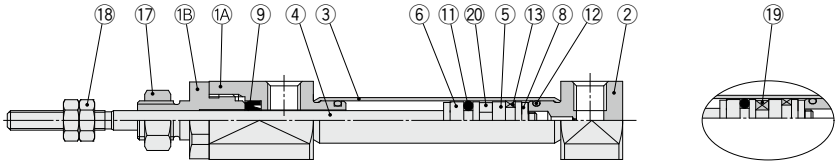

With auto switch

ø10, ø16
Rubber bumper

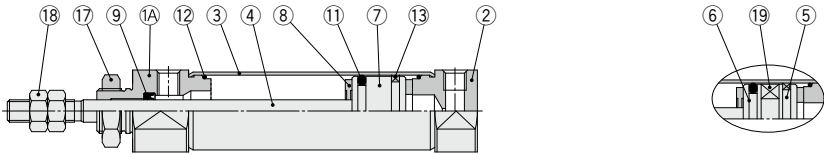

With auto switch

ø10, ø16
Air cushion

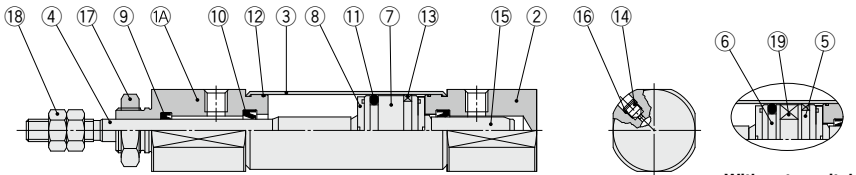

With auto switch

Component Parts

No.	Description	Material	Note
1A	Rod cover	Aluminum alloy	
1B	Seal retainer	Aluminum alloy	ø6 only
2	Head cover	Aluminum alloy	
3	Cylinder tube	Stainless steel	
4	Piston rod	Stainless steel	
5	Piston A	Aluminum alloy	
6	Piston B	Aluminum alloy	
7	Piston	Aluminum alloy	
8	Bumper	Urethane	
9	Rod seal	NBR	
10	Cushion seal	NBR	

No.	Description	Material	Note
11	Piston seal	NBR	
12	Tube gasket	NBR	
13	Wear ring	Resin	
14	Cushion needle	Carbon steel	
15	Cushion ring	Aluminum alloy	
16	Needle seal	NBR	
17	Mounting nut	Rolled steel	
18	Rod end nut	Rolled steel	
19	Magnet	—	
20	Spacer	Aluminum alloy	ø6: Without magnet

CJ2 Series

Dimensions

Basic (B)

CJ2B6 – Stroke Head cover port location Z

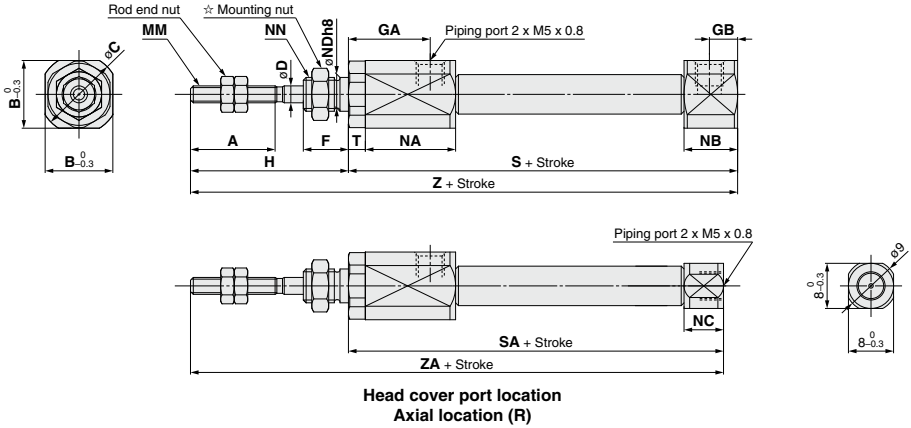

CJ2B $\frac{10}{16}$ – Stroke Head cover port location Z

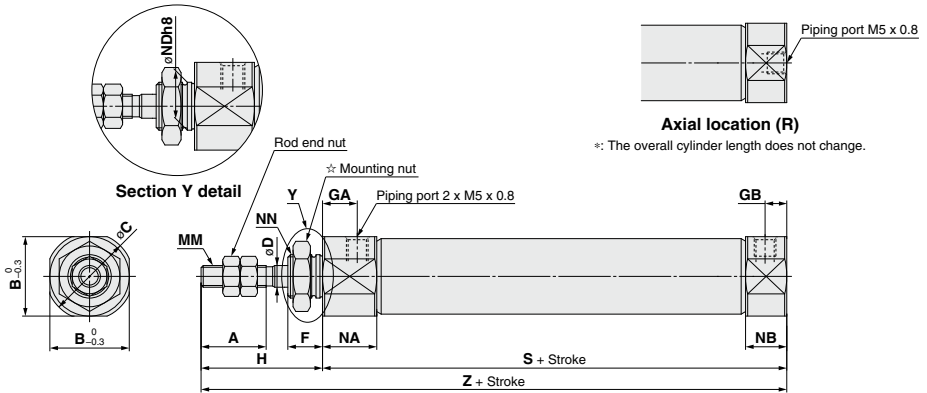

☆ For details of the mounting nut, refer to page 91.

Bore size	A	B	C	D	F	GA	GB	H	MM	NA	NB	NC	Ndh8	NN	S	SA	T	Z	ZA
6	15	12	14	3	8	14.5	5	28	M3 x 0.5	16	9.5	7	$6_{-0.018}^0$	M6 x 1.0	51.5	49	3	79.5	77
10	15	12	14	4	8	8	5	28	M4 x 0.7	12.5	9.5	—	$8_{-0.022}^0$	M8 x 1.0	46	—	—	74	—
16	15	18.3	20	5	8	8	5	28	M5 x 0.8	12.5	9.5	—	$10_{-0.022}^0$	M10 x 1.0	47	—	—	75	—

Dimensions

Basic (B)

With air cushion: CJ2B $\frac{10}{16}$ – Stroke | A | Head cover port location | Z

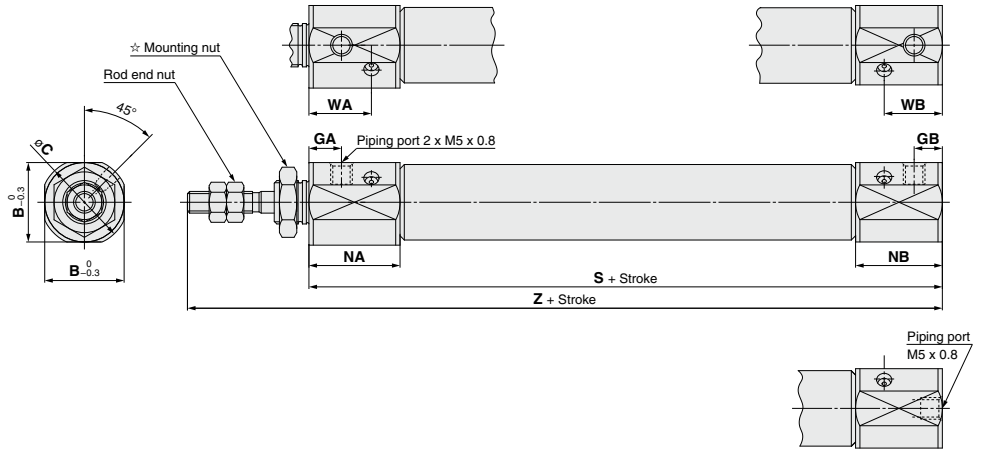

☆ For details of the mounting nut, refer to page 91.

Dimensions other than the table below are the same as those on page 78. [mm]

Bore size	B	C	GA	GB	NA	NB	WA	WB	S	Z
10	15	17	7.5	6.5	21	20	14.4	13.4	65	93
16	18.3	20	7.5	6.5	21	20	14.4	13.4	66	94

*: The overall cylinder length does not change.

CJ2 Series

Dimensions

Single foot (L)

CJ2L6 – Stroke Head cover port location Z

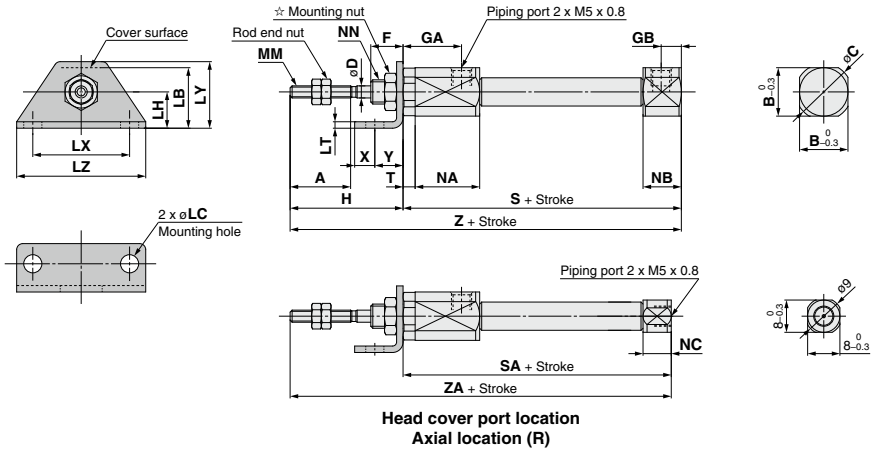

CJ2L $\frac{10}{16}$ – Stroke Head cover port location Z

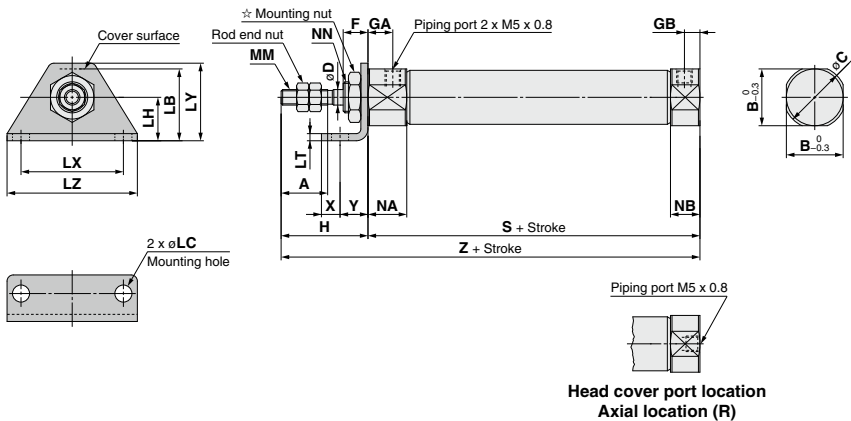

*: The overall cylinder length does not change.

☆ For details of the mounting nut, refer to page 91.

Bore size	A	B	C	D	F	GA	GB	H	LB	LC	LH	LT	LX	LY	LZ	MM	NA	NB	NC	NN	S	SA	T	X	Y	Z	ZA
6	15	12	14	3	8	14.5	5	28	15	4.5	9	1.6	24	16.5	32	M3 x 0.5	16	9.5	7	M6 x 1.0	51.5	49	3	5	7	79.5	77
10	15	12	14	4	8	8	5	28	15	4.5	9	1.6	24	16.5	32	M4 x 0.7	12.5	9.5	—	M8 x 1.0	46	—	—	5	7	74	—
16	15	18.3	20	5	8	8	5	28	23	5.5	14	2.3	33	25	42	M5 x 0.8	12.5	9.5	—	M10 x 1.0	47	—	—	6	9	75	—

Dimensions

Single foot (L)

With air cushion: CJ2L $\frac{10}{16}$ – Stroke A Head cover port location Z

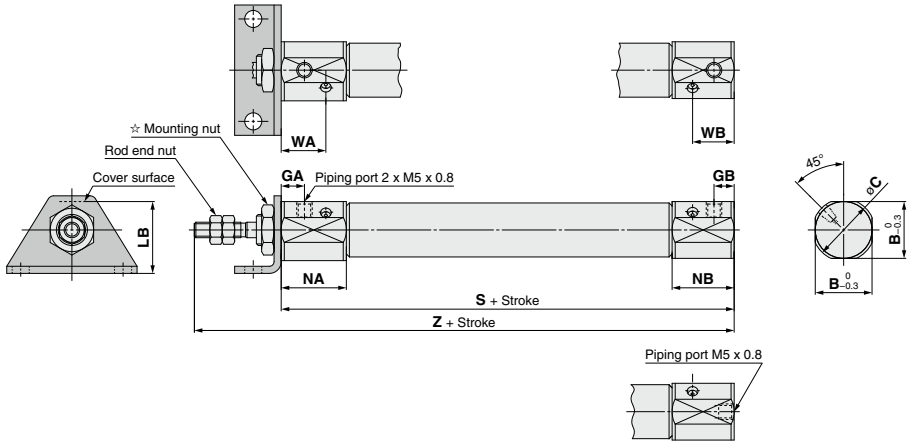

Head cover port location Axial location (R)

*: The overall cylinder length does not change.

☆ For details of the mounting nut, refer to page 91.

Dimensions other than the table below are the same as those on page 80. [mm]

Bore size	B	C	GA	GB	LB	NA	NB	WA	WB	S	Z
10	15	17	7.5	6.5	16.5	21	20	14.4	13.4	65	93
16	18.3	20	7.5	6.5	23	21	20	14.4	13.4	66	94

CJ2 Series

Dimensions

Double foot (M)

CJ2M6 – Stroke Z

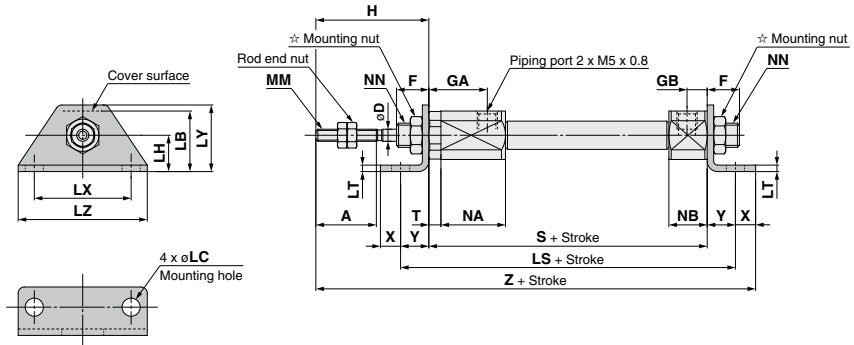

CJ2M¹⁰/₁₆ – Stroke Z

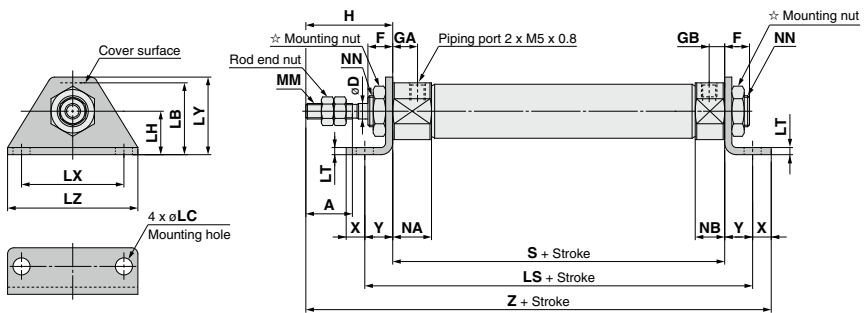

☆ For details of the mounting nut, refer to page 91.

Bore size	A	D	F	GA	GB	H	LB	LC	LH	LS	LT	LX	LY	LZ	MM	NA	NB	NN	S	T	X	Y	Z
6	15	3	8	14.5	5	28	15	4.5	9	65.5	1.6	24	16.5	32	M3 x 0.5	16	9.5	M6 x 1.0	51.5	3	5	7	91.5
10	15	4	8	8	5	28	15	4.5	9	60	1.6	24	16.5	32	M4 x 0.7	12.5	9.5	M8 x 1.0	46	—	5	7	86
16	15	5	8	8	5	28	23	5.5	14	65	2.3	33	25	42	M5 x 0.8	12.5	9.5	M10 x 1.0	47	—	6	9	90

Dimensions

Double foot (M)

With air cushion: CJ2M $\frac{10}{16}$ - Stroke AZ

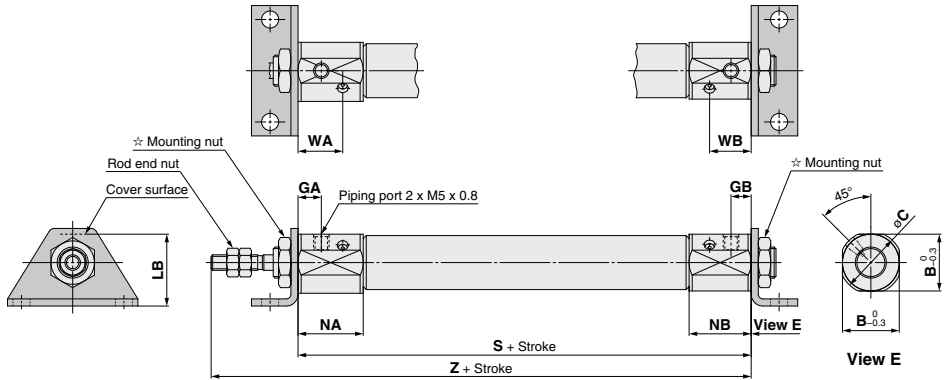

☆ For details of the mounting nut, refer to page 91.

With Air Cushion Dimensions other than the table below are the same as those on page 82. [mm]

Bore size	B	C	GA	GB	LB	NA	NB	WA	WB	S	Z
10	15	17	7.5	6.5	16.5	21	20	14.4	13.4	65	93
16	18.3	20	7.5	6.5	23	21	20	14.4	13.4	66	94

CJ2 Series

Dimensions

Rod flange (F)

CJ2F6 – Stroke Head cover port location Z

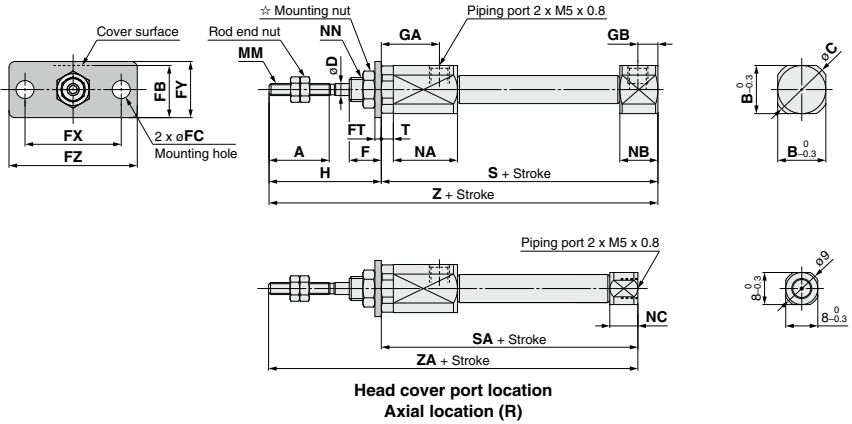

CJ2F 10/16 – Stroke Head cover port location Z

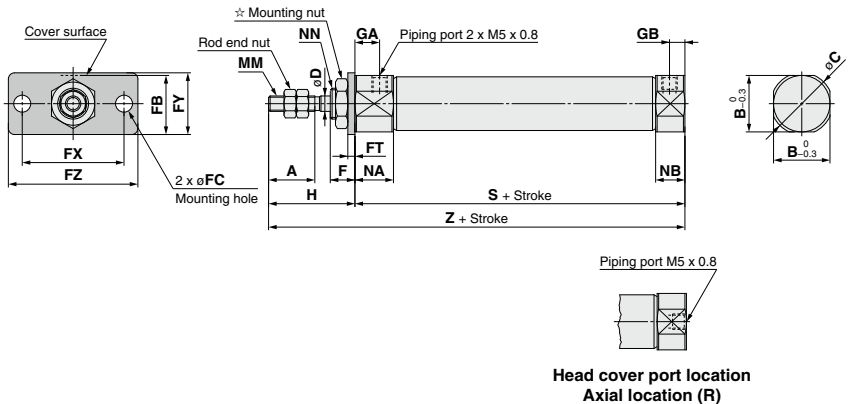

※ The overall cylinder length does not change.

☆ For details of the mounting nut, refer to page 91.

Bore size	A	B	C	D	F	FB	FC	FT	FX	FY	FZ	GA	GB	H	MM	NA	NB	NC	NN	S	SA	T	Z	ZA
6	15	12	14	3	8	13	4.5	1.6	24	14	32	14.5	5	28	M3 x 0.5	16	9.5	7	M6 x 1.0	51.5	49	3	79.5	77
10	15	12	14	4	8	13	4.5	1.6	24	14	32	8	5	28	M4 x 0.7	12.5	9.5	—	M8 x 1.0	46	—	—	74	—
16	15	18.3	20	5	8	19	5.5	2.3	33	20	42	8	5	28	M5 x 0.8	12.5	9.5	—	M10 x 1.0	47	—	—	75	—

Dimensions

Rod flange (F)

With air cushion: CJ2F $\frac{10}{16}$ – Stroke | A | Head cover port location | Z

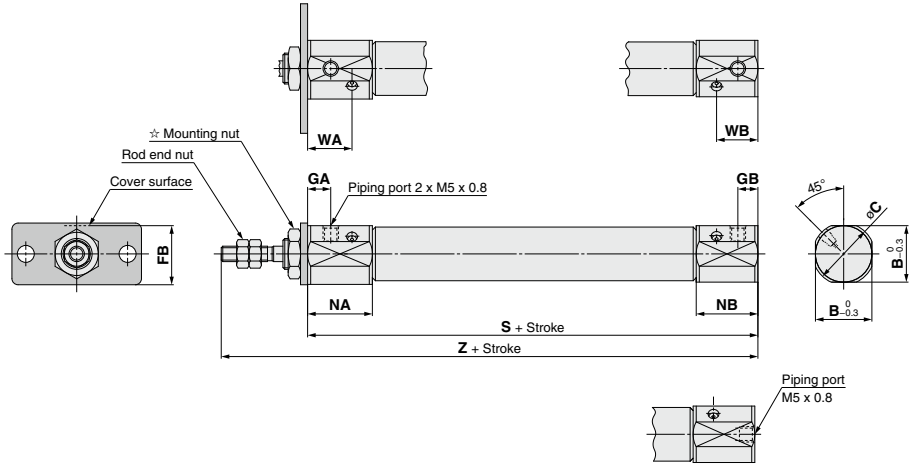

Head cover port location Axial location (R)

*: The overall cylinder length does not change.

☆ For details of the mounting nut, refer to page 91.

Dimensions other than the table below are the same as those on page 84. [mm]

Bore size	B	C	FB	GA	GB	NA	NB	WA	WB	S	Z
10	15	17	14.5	7.5	6.5	21	20	14.4	13.4	65	93
16	18.3	20	19	7.5	6.5	21	20	14.4	13.4	66	94

CJ2 Series

Dimensions

Head flange (G)

CJ2G6 – Stroke Z

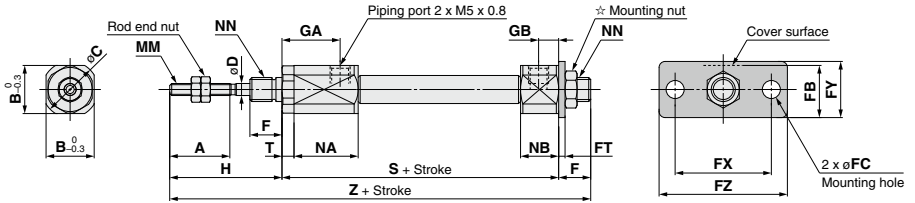

CJ2G 10/16 – Stroke Z

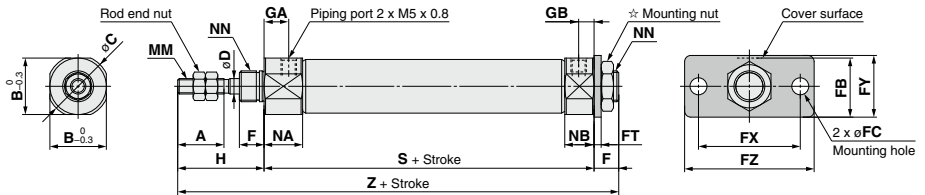

☆ For details of the mounting nut, refer to page 91.

Bore size	A	B	C	D	F	FB	FC	FT	FX	FY	FZ	GA	GB	H	MM	NA	NB	NN	S	T	Z
6	15	12	14	3	8	13	4.5	1.6	24	14	32	14.5	5	28	M3 x 0.5	16	9.5	M6 x 1.0	51.5	3	87.5
10	15	12	14	4	8	13	4.5	1.6	24	14	32	8	5	28	M4 x 0.7	12.5	9.5	M8 x 1.0	46	—	82
16	15	18.3	20	5	8	19	5.5	2.3	33	20	42	8	5	28	M5 x 0.8	12.5	9.5	M10 x 1.0	47	—	83

Dimensions

Head flange (G)

With air cushion: CJ2G $\frac{10}{16}$ - Stroke AZ

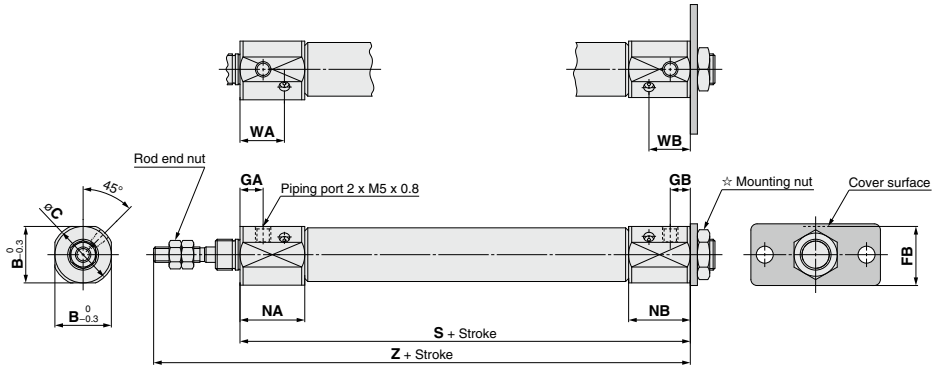

☆ For details of the mounting nut, refer to page 91.

With Air Cushion/Dimensions other than the table below are the same as those on page 86. [mm]

Bore size	B	C	FB	GA	GB	NA	NB	WA	WB	S	Z
10	15	17	14.5	7.5	6.5	21	20	14.4	13.4	65	93
16	18.3	20	19	7.5	6.5	21	20	14.4	13.4	66	94

CJ2 Series

Dimensions

Double clevis (D)

CJ2D $\frac{10}{16}$ - Stroke Z

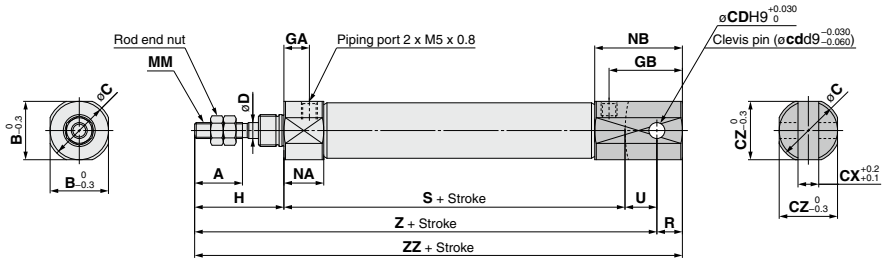

With air cushion: CJ2D $\frac{10}{16}$ - Stroke AZ

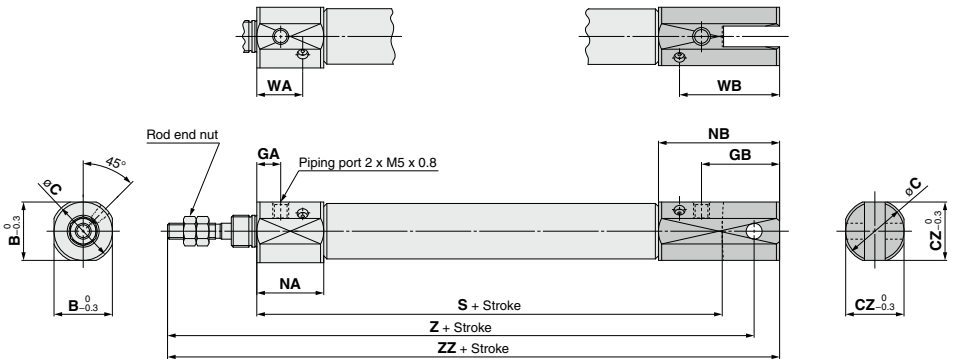

※: A clevis pin and retaining rings are included.

Bore size	A	B	C	CD (cd)	CX	CZ	D	GA	GB	H	MM	NA	NB	R	S	U	Z	ZZ
10	15	12	14	3.3	3.2	12	4	8	18	28	M4 x 0.7	12.5	22.5	5	46	8	82	87
16	15	18.3	20	5	6.5	18.3	5	8	23	28	M5 x 0.8	12.5	27.5	8	47	10	85	93

With Air Cushion/Dimensions other than the table below are the same as the table above. [mm]

Bore size	B	C	CZ	GA	GB	NA	NB	WA	WB	S	Z	ZZ
10	15	17	15	7.5	19.5	21	33	14.4	26.4	65	101	106
16	18.3	20	18.3	7.5	24.5	21	38	14.4	31.4	66	104	112

Dimensions

Double-side bossed (E)

CJ2E6 – Stroke Z

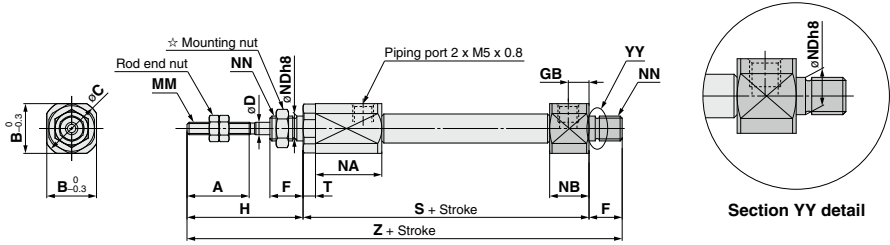

CJ2E 10/16 – Stroke Z

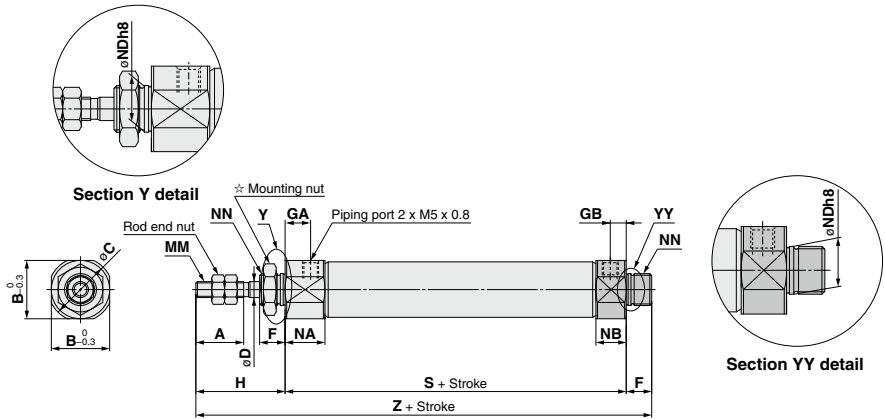

☆ For details of the mounting nut, refer to page 91.

Bore size	A	B	C	D	F	GA	GB	H	MM	NA	NB	NDh8	NN	S	T	Z
6	15	12	14	3	8	14.5	5	28	M3 x 0.5	16	9.5	$6_{-0.018}^0$	M6 x 1.0	51.5	3	87.5
10	15	12	14	4	8	8	5	28	M4 x 0.7	12.5	9.5	$8_{-0.022}^0$	M8 x 1.0	46	—	82
16	15	18.3	20	5	8	8	5	28	M5 x 0.8	12.5	9.5	$10_{-0.022}^0$	M10 x 1.0	47	—	83

CJ2 Series

Dimensions

Double-side bossed (E)

With air cushion: CJ2E $\frac{10}{16}$ - Stroke AZ

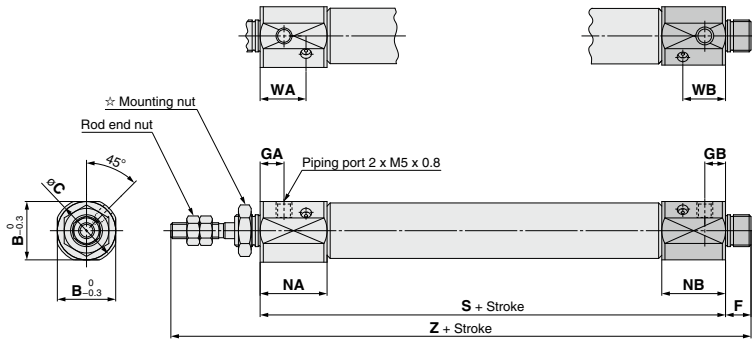

☆ For details of the mounting nut, refer to page 91.

With Air Cushion Dimensions other than the table below are the same as those on page 89. [mm]

Bore size	B	C	GA	GB	NA	NB	WA	WB	S	Z
10	15	17	7.5	6.5	21	20	14.4	13.4	65	101
16	18.3	20	7.5	6.5	21	20	14.4	13.4	66	102

CJ2 Series

Dimensions of Accessories (Options)

Single Knuckle Joint Material: Rolled steel

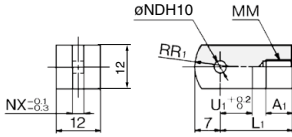

[mm]

Part no.	Applicable bore size	A ₁	L ₁	MM	NDH10	NX	R ₁	U ₁
I-J010C	10	8	21	M4 x 0.7	3.3 ^{+0.048} ₀	3.1	8	9
I-J016C	16	8	25	M5 x 0.8	5 ^{+0.048} ₀	6.4	12	14

Double Knuckle Joint Material: Rolled steel

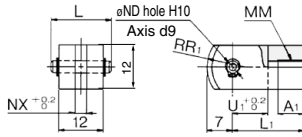

[mm]

Part no.	Applicable bore size	A ₁	L	L ₁	MM
Y-J010C	10	8	15.2	21	M4 x 0.7
Y-J016C	16	11	16.6	21	M5 x 0.8

Part no.	NDd9	NDH10	NX	R ₁	U ₁
Y-J010C	3.3 ^{+0.030} _{-0.060}	3.3 ^{+0.048} ₀	3.2	8	10
Y-J016C	5 ^{+0.030} _{-0.060}	5 ^{+0.048} ₀	6.5	12	10

**: A knuckle pin and retaining rings are included.

Knuckle Pin Material: Stainless steel

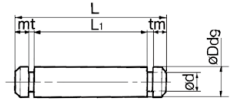

[mm]

Part no.	Applicable bore size	Dd	d	L	L ₁	m	t	Included retaining ring
CD-J010	10	3.3 ^{+0.030} _{-0.060}	3	15.2	12.2	1.2	0.3	Type C 3.2
IY-J015	16	5 ^{+0.030} _{-0.060}	4.8	16.6	12.2	1.5	0.7	Type C 5

**: For Ø10, a clevis pin is diverted.
**: Retaining rings are included with a knuckle pin.

Double Knuckle Joint (With One-touch Connecting Pin)

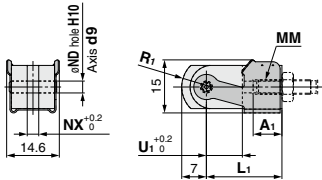

[mm]

Part no.	Applicable bore size	A ₁	L ₁	MM	NDd9	NDH10	NX	R ₁	U ₁
Y-J10	10	8	21	M4 x 0.7	3.3 ^{+0.030} _{-0.060}	3.3 ^{+0.048} ₀	3.2	8	10
Y-J16	16	11	21	M5 x 0.8	5 ^{+0.030} _{-0.060}	5 ^{+0.048} ₀	6.5	12	10

One-touch Connecting Pin for Double Knuckle Joint Material: Stainless steel

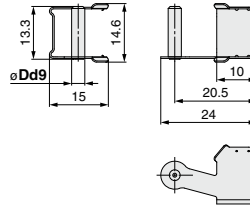

[mm]

Part no.	Applicable bore size	Dd9
IY-J10	10	3.3 ^{+0.030} _{-0.060}
IY-J16	16	5 ^{+0.030} _{-0.060}

Mounting Nut Material: Carbon steel

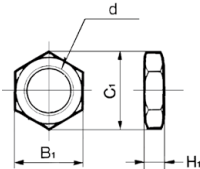

[mm]

Part no.	Applicable bore size	B ₁	C ₁	d	H ₁
SNJ-006C	6	8	9.2	M6 x 1.0	4
SNJ-010C	10	11	12.7	M8 x 1.0	4
SNJ-016C	16	14	16.2	M10 x 1.0	4
SNKJ-016C*	16	17	19.6	M12 x 1.0	4

**: For Ø16 non-rotating type. (Use SNJ-016C for Ø10 non-rotating type.)

Rod End Nut Material: Carbon steel

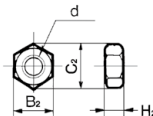

[mm]

Part no.	Applicable bore size	B ₂	C ₂	d	H ₂
NTJ-006B	6	5.5	6.4	M3 x 0.5	2.4
NTJ-010C	10	7	8.1	M4 x 0.7	3.2
NTJ-015C	16	8	9.2	M5 x 0.8	4

CJ2 Series

Pivot Bracket (T-bracket)

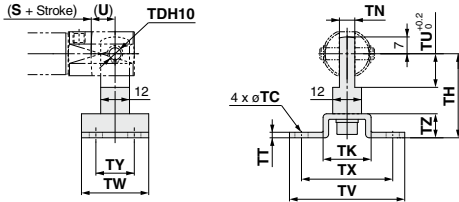

Part no.	Applicable bore size	TC	TDH10	TH	TK	TN	TT	TU	TV	TW	TX	TY	TZ
CJ-T010C	10	4.5	3.3 ^{+0.048} ₀	29	18	3.1	2	9	40	22	32	12	8
CJ-T016C	16	5.5	5 ^{+0.048} ₀	35	20	6.4	2.3	14	48	28	38	16	10

*: A T-bracket includes a T-bracket base, single knuckle joint, hexagon socket head bolt and spring washer.

*: For dimensions of (U) and (S + Stroke), refer to the double clevis drawing on page 88.

Clevis Pin

Material: Stainless steel

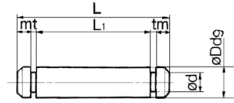

Part no.	Applicable bore size	Dd9	d	L	L ₁	m	t	Included retaining ring
CD-J010	10	3.3 ^{+0.030} _{-0.060}	3	15.2	12.2	1.2	0.3	Type C 3.2
CD-Z015	16	5 ^{+0.030} _{-0.060}	4.8	22.7	18.3	1.5	0.7	Type C 5
CD-JA010*	10	3.3 ^{+0.030} _{-0.060}	3	18.2	15.2	1.2	0.3	Type C 3.2

*: For ø10 double clevis type, with air cushion and built-in speed controller.

*: Retaining rings are included with a clevis pin.

One-touch Connecting Pin for Double Clevis

Material: Stainless steel

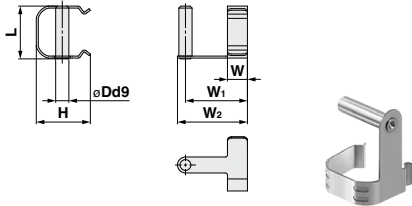

Part no.	Applicable bore size	Dd9	H	L	W
CD-J10	10	3.3 ^{+0.030} _{-0.060}	13.4	13.2	4
CD-J16	16	5 ^{+0.030} _{-0.060}	18.2	19.5	5

Part no.	W ₁	W ₂	Note
CD-J10	12	15	Cannot be mounted on cylinders with air cushion, or rail mounting type auto switches.
CD-J16	15	18	

*: Please pay attention to the applicable cylinder.

Rod End Cap

Material: Polyacetal

Flat type/CJ-CF□□□

Round type/CJ-CR□□□

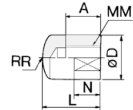
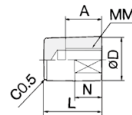

Part no.	Applicable bore size	A	D	L	MM	N	R	W	
CJ-CF006	CJ-CR006	6	6	8	11	M3 x 0.5	5	8	6
CJ-CF010	CJ-CR010	10	8	10	13	M4 x 0.7	6	10	8
CJ-CF016	CJ-CR016	16	10	12	15	M5 x 0.8	7	12	10

Mounting Brackets, Rod End Brackets, and Nut Material: Stainless Steel

Part No. (Dimensions: Same as standard type)

Bore size [mm]	Foot	Flange	Single knuckle joint	Double knuckle joint*	Mounting nut	Rod end nut
10	—	—	I-J010SUS	Y-J010SUS	—	NTJ-010SUS
16	CJ-L016SUS	CJ-F016SUS	I-J016SUS	Y-J016SUS	SNJ-016SUS	NTJ-016SUS

*: A knuckle pin and retaining rings are shipped together.

Precautions

Assembly Procedures

1. Double Clevis (With One-touch Connecting Pin) (CD-J□)

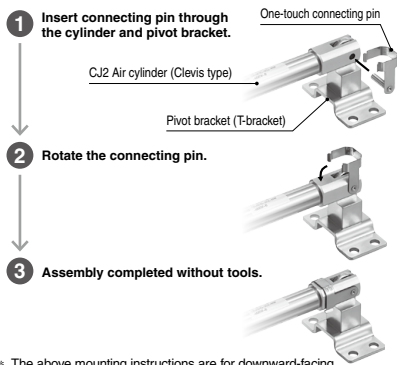

* The above mounting instructions are for downward-facing ports. Refer to the following for upward-facing ports.

2. Double Knuckle Joint (With One-touch Connecting Pin) (IV-J□)

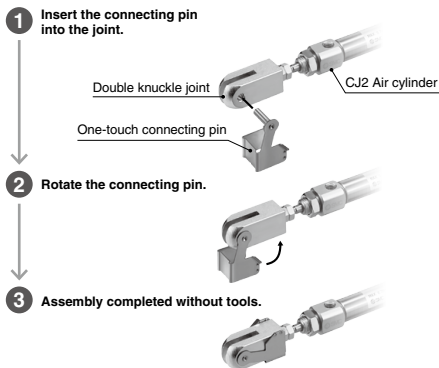

How to Mount the Double Clevis (With One-touch Connecting Pin)

When connecting a double clevis cylinder to a pivot bracket (T-bracket), it is recommended that the pivot bracket (T-bracket) and the cylinder be connected with the one-touch connecting pin first, before fastening the pivot bracket.

When connecting the cylinder after the pivot bracket (T-bracket) has been fastened, mount the cylinder according to the following procedure.

⚠ Warning

For assembling the clevis type to the pivot bracket, refer to the figure below.

1. Insert the double clevis (One-touch connecting pin) from the direction in the figure.

When port is facing upward

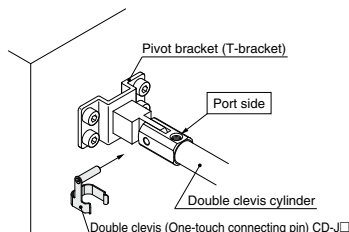

When port is facing downward

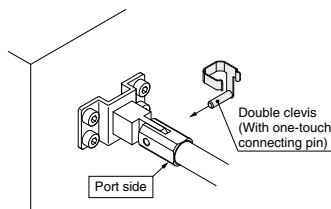

⚠ Warning

* Perform the mounting within the following range.

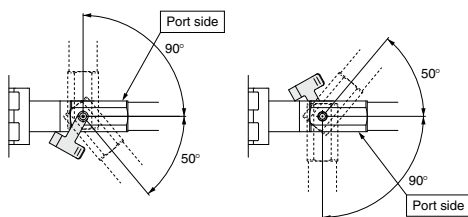

2. Push the one-touch connecting pin into the cylinder body (Double clevis) until it clicks and is firmly fastened.

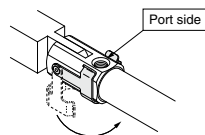

* Attach the double knuckle joint within 180° (±90° from center). Other mounting methods are the same as the above.

Air Cylinder: Standard Type Double Acting, Double Rod

CJ2W Series

ø6, ø10, ø16



How to Order

With auto switch

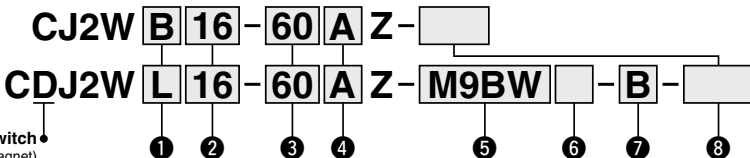

With auto switch
(Built-in magnet)

① Mounting

B	Basic
L	Foot
F	Flange

*: Foot/Flange brackets are shipped together with the product, but not assembled.

⑤ Auto switch

Nil	Without auto switch
------------	---------------------

*: For applicable auto switches, refer to the table below.

★ Enter the auto switch mounting type (A or B) even when a built-in magnet cylinder without an auto switch is required.

② Bore size

6	6 mm
10	10 mm
16	16 mm

③ Cylinder standard stroke [mm]

Refer to "Standard Strokes" on page 95.

④ Cushion

Nil	Rubber bumper
A	Air cushion

*: ø6: Rubber bumper only

⑦ Auto switch mounting type

A	Rail mounting
B	Band mounting

*: For rail mounting, screws and nuts for 2 auto switches come with the rail.

*: Refer to page 178 for auto switch mounting brackets.

*: ø6: Band mounting only

⑧ Made to Order

Refer to page 95 for details.

Applicable Auto Switches/Refer to pages 1271 to 1365 for further information on auto switches.

Type	Special function	Electrical entry	Indicate light	Wiring (Output)	Load voltage		Auto switch model				Lead wire length [m]				Pre-wired connector	Applicable load		
					DC	AC	Band mounting		Rail mounting		0.5 (Nil)	1 (M)	3 (L)	5 (Z)			None (N)	
							Perpendicular	In-line	Perpendicular	In-line								
Solid state auto switch	—	Grommet	—	3-wire (PNP)	5 V, 12 V	—	M9NV	M9N	M9NV	M9N	●	●	●	○	○	IC circuit		
				3-wire (PNP)			M9PV	M9P	M9PV	M9P	●	●	●	○	○			
		Connector	2-wire	M9BV			M9B	M9BV	M9B	●	●	●	○	○	—			
			—	H7C			H7C	H7C	●	●	●	●	●					
	Diagnostic indication (2-color indicator)	Grommet	Yes	3-wire (NPN)	24 V	—	M9NVV	M9NV	M9NVV	M9NV	●	●	●	○	○	IC circuit		
				3-wire (PNP)			M9PWV	M9PW	M9PWV	M9PW	●	●	●	○	○			
		Connector	2-wire	M9BWW			M9BW	M9BWW	M9BW	●	●	●	○	○	—			
			—	M9NAV*1			M9NA*1	M9NAV*1	M9NA*1	○	○	○	○	○				
		Grommet	—	3-wire (NPN)			M9PAV*1	M9PA*1	M9PAV*1	M9PA*1	○	○	○	○	○		IC circuit	
				3-wire (PNP)			M9BAV*1	M9BA*1	M9BAV*1	M9BA*1	○	○	○	○	○			
Connector	—	2-wire	M9BAV*1	M9BA*1	M9BAV*1	M9BA*1	○	○	○	○	○	—						
		—	H7NF	H7NF	H7NF	●	●	●	○	○								
Reed auto switch	—	Grommet	Yes	3-wire (NPN equivalent)	24 V	12 V	A96V	A96	A96V	A96	●	—	—	—	—	IC circuit		
							—	—	A72	A72H	●	—	—	—	—			
							—	—	A93V*2	A93	A93V*2	A93	●	●	●		—	—
							—	—	A90V	A90	A90V	A90	●	—	—		—	—
							—	—	C73C	A73C	—	—	●	—	—		—	—
		Connector	No	2-wire			—	100 V or less	A90V	A90	A90V	A90	●	—	—	—	—	IC circuit
								—	—	C73C	A73C	—	—	●	—	—	—	
								—	—	C80C	A80C	—	—	●	—	—	—	
								—	—	—	A79W	—	—	●	—	—	—	
								—	—	—	A79W	—	—	●	—	—	—	
Grommet	Yes	—	—	24 V or less	—	—	—	—	—	●	—	—	—	IC circuit				
				—	—	—	—	—	—	●	—	—	—					

*1: Water resistant type auto switches can be mounted on the above models, but in such case SMC cannot guarantee water resistance.

Please contact SMC regarding water resistant types with the above model numbers.

*2: 1 m type lead wire is only applicable to D-A93.

*: Lead wire length symbols: 0.5 m..... Nil (Example) M9NV
1 m..... M (Example) M9NVW
3 m..... L (Example) M9NWL
5 m..... Z (Example) M9NWZ
None..... N (Example) H7CN

*: Since there are other applicable auto switches than listed above, refer to page 179 for details.

*: Solid state auto switches marked with "○" are produced upon receipt of order.

*: The D-A9□/M9□/A7□/A8□/F7□/J7□ auto switches are shipped together, but not assembled. (For band mounting, only the auto switch mounting brackets are assembled before shipment.)



Symbol

Double acting, Double rod, Rubber bumper

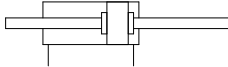

Air cushion

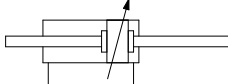

Made to Order: Individual Specifications
(For details, refer to page 180.)

Symbol	Specifications
-X446	PTFE grease

Made to Order

[Click here for details](#)

Symbol	Specifications
-XA	Change of rod end shape
-XB6	Heat resistant cylinder (-10 to 150°C) * Not available with switch & with air cushion
-XB7	Cold resistant cylinder (-40 to 70°C) * Not available with switch & with air cushion
-XC22	Fluororubber seal * Not available with air cushion
-XC51	With hose nipple
-XC85	Grease for food processing equipment

Refer to pages 172 to 179 for cylinders with auto switches.

- Auto switch proper mounting position (detection at stroke end) and its mounting height
- Minimum stroke for auto switch mounting
- Operating range
- Auto switch mounting brackets/Part no.

⚠ Precautions

Refer to page 183 before handling.

Moisture Control Tube IDK Series



When operating an actuator with a small diameter and a short stroke at a high frequency, the dew condensation (water droplet) may occur inside the piping depending on the conditions. Simply connecting the moisture control tube to the actuator will prevent dew condensation from occurring. For details, refer to the [Web Catalog](#).

Specifications

Bore size [mm]		6	10	16
Action		Double acting, Double rod		
Fluid		Air		
Proof pressure		1 MPa		
Maximum operating pressure		0.7 MPa		
Minimum operating pressure	Rubber bumper	0.15 MPa		0.1 MPa
	Air cushion	—		0.1 MPa
Ambient and fluid temperature		Without auto switch: -10°C to 70°C With auto switch: -10°C to 60°C (No freezing)		
Cushion		Rubber bumper	Rubber bumper/Air cushion	
Lubrication		Not required (Non-Lube)		
Piston speed	Rubber bumper	50 to 750 mm/s		
	Air cushion	—	50 to 1000 mm/s	
Allowable kinetic energy	Rubber bumper	0.012 J	0.035 J	0.090 J
	Air cushion (Effective cushion length)	—	0.07 J (9.4 mm)	0.18 J (9.4 mm)
Stroke length tolerance		+1.0 0		

Standard Strokes

Bore size	Standard stroke [mm]
6	15, 30, 45, 60
10	15, 30, 45, 60, 75, 100, 125, 150
16	15, 30, 45, 60, 75, 100, 125, 150, 175, 200

- *: Manufacture of intermediate strokes in 1 mm increments is possible. (Spacers are not used.) Produced upon receipt of order.
- *: Please consult with SMC for strokes which exceed the standard stroke length.
- *: Applicable strokes should be confirmed according to the usage. For details, refer to "Air Cylinders Model Selection" on pages 8 to 19. In addition, the products that exceed the standard stroke might not be able to fulfill the specifications due to the deflection etc.

Mounting and Accessories

Refer to page 68 for the list of brackets and page 91 for details about part numbers and dimensions.

●---Mounted on the product. ○---Please order separately.

Mounting		Basic	Foot	Flange
Standard	Mounting nut	●	●	●
	Rod end nut	●	●	●
Option	Single knuckle joint	○	○	○
	Double knuckle joint (including a pin and retaining rings)	○	○	○
	Double knuckle joint (With one-touch connecting pin)	○	○	○
	Rod end cap (Flat/Round type)	○	○	○

- *: ø10 and ø16 only
- *: Stainless steel mounting brackets and accessories are also available. Refer to page 92 for details.

Mounting Brackets/Part No.

Mounting bracket	Bore size [mm]		
	6	10	16
Foot	CJ-L006C	CJ-L010C	CJ-L016C
Flange	CJ-F006C	CJ-F010C	CJ-F016C

Weights

Bore size [mm]	Rubber bumper			Air cushion	
	6	10	16	10	16
Basic weight (When the stroke is zero)	Basic	25	29	56	61
Additional weight per 15 mm of stroke	Foot	3	4.5	7.5	4.5
	Flange	5	5	13	5
Accessories	Mounting bracket weight	16	16	50	16
	Single knuckle joint	5	17	23	17
	Double knuckle joint (including knuckle pin)	—	25	21	25
	Double knuckle joint (With one-touch connecting pin)	—	26	22	26
	Rod end cap (Flat type)	1	1	2	1
Rod end cap (Round type)	1	1	2	1	

- *: Mounting nut and rod end nut are included in the basic weight.

Calculation:

Example) **CJ2WL10-45Z**

- Basic weight 29 (ø10)
- Additional weight 4.5/15 stroke
- Cylinder stroke 45 stroke
- Mounting bracket weight 16 (Foot)

$$29 + 4.5/15 \times 45 + 16 = 58.5 \text{ g}$$

CJ2W Series

Clean Series

10-CJ2W Mounting 10 16 - Stroke Z
Clean Series

Air cylinder which is applicable for the system which discharges leakage from the rod section directly into the outside of clean room by relief port and making an actuator's rod section having a double seal construction.

For the detailed specifications, refer to the [Web Catalog](#).

Specifications

Action	Double acting, Double rod
Bore size [mm]	10, 16
Maximum operating pressure	0.7 MPa
Minimum operating pressure	0.1 MPa
Cushion	Rubber bumper
Standard stroke [mm]	Same as standard type. (Refer to page 95.)
Auto switch	Mountable (Band mounting)
Mounting	Basic, Foot, Flange

Construction (Not able to disassemble)

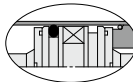
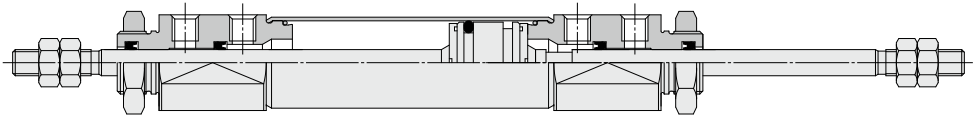

With auto switch

Construction (Not able to disassemble)

ø6
 Rubber bumper

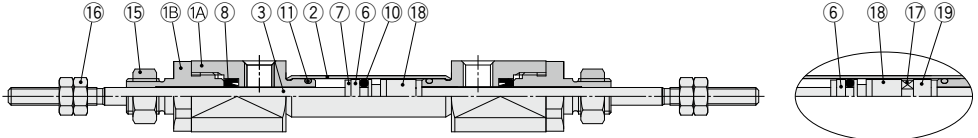

With auto switch

ø10, ø16
 Rubber bumper

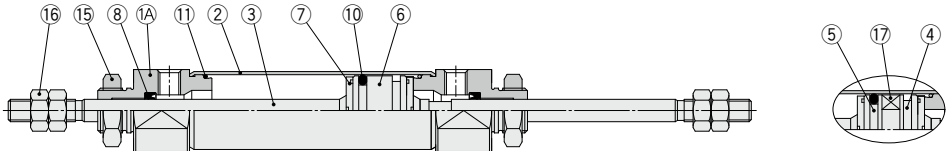

With auto switch

ø10, ø16
 Air cushion

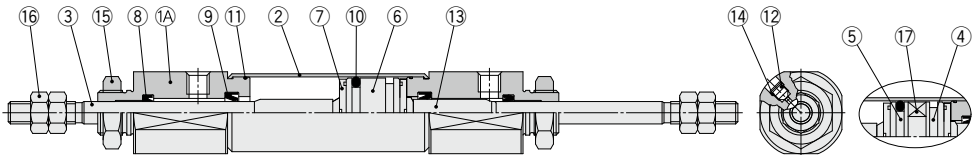

With auto switch

Component Parts

No.	Description	Material	Note
1A	Rod cover	Aluminum alloy	
1B	Seal retainer	Aluminum alloy	ø6 only
2	Cylinder tube	Stainless steel	
3	Piston rod	Stainless steel	
4	Piston A	Aluminum alloy	
5	Piston B	Aluminum alloy	
6	Piston	Aluminum alloy	
7	Bumper	Urethane	
8	Rod seal	NBR	
9	Cushion seal	NBR	

No.	Description	Material	Note
10	Piston seal	NBR	
11	Tube gasket	NBR	
12	Cushion needle	Carbon steel	
13	Cushion ring	Aluminum alloy	
14	Needle seal	NBR	
15	Mounting nut	Rolled steel	
16	Rod end nut	Rolled steel	
17	Magnet	—	
18	Spacer A	Aluminum alloy	ø6 only
19	Spacer B	Aluminum alloy	ø6 only

CJ2W Series

Basic (B)

CJ2WB6 – Stroke Z

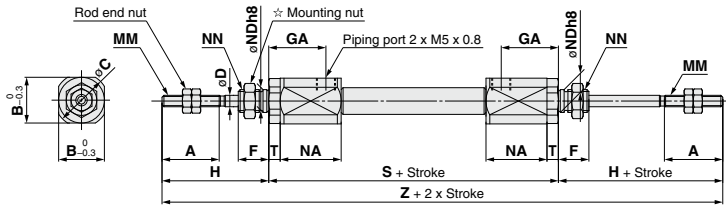

CJ2WB 10/16 – Stroke Z

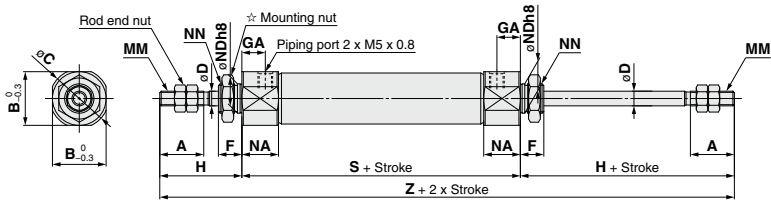

With air cushion: CJ2WB 10/16 – Stroke AZ

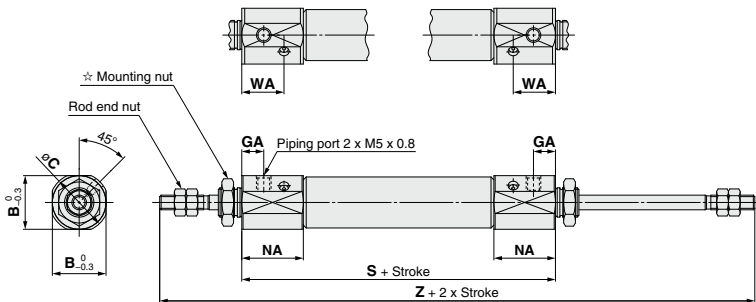

☆ For details of the mounting nut, refer to page 91.

Bore size	A	B	C	D	F	GA	H	MM	NA	NDh8	NN	S	T	Z
6	15	12	14	3	8	14.5	28	M3 x 0.5	16	6 ⁰ _{-0.018}	M6 x 1.0	61 (66)	3	117 (122)
10	15	12	14	4	8	8	28	M4 x 0.7	12.5	8 ⁰ _{-0.022}	M8 x 1.0	49	—	105
16	15	18.3	20	5	8	8	28	M5 x 0.8	12.5	10 ⁰ _{-0.022}	M10 x 1.0	50	—	106

With Air Cushion/Dimensions other than the table above are the same as the table above.

☆: () in S and Z dimensions: With auto switch

Bore size	B	C	GA	NA	WA	S	Z
10	15	17	7.5	21	14.4	66	122
16	18.3	20	7.5	21	14.4	67	123

Foot (L)

CJ2WL6 – Stroke Z

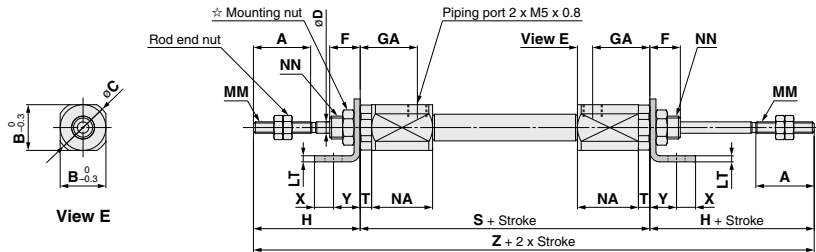

CJ2WL 10/16 – Stroke Z

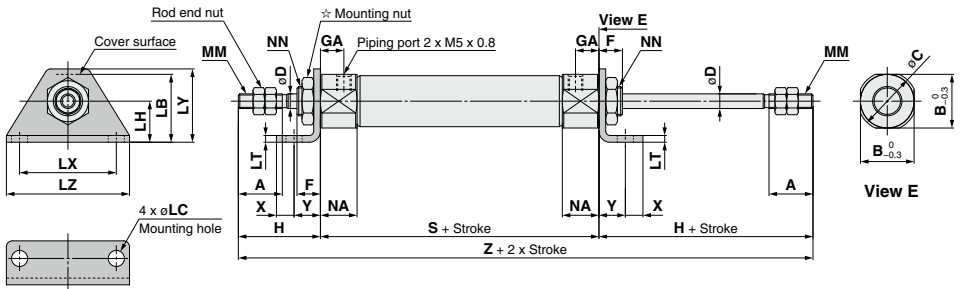

With air cushion: CJ2WL 10/16 – Stroke AZ

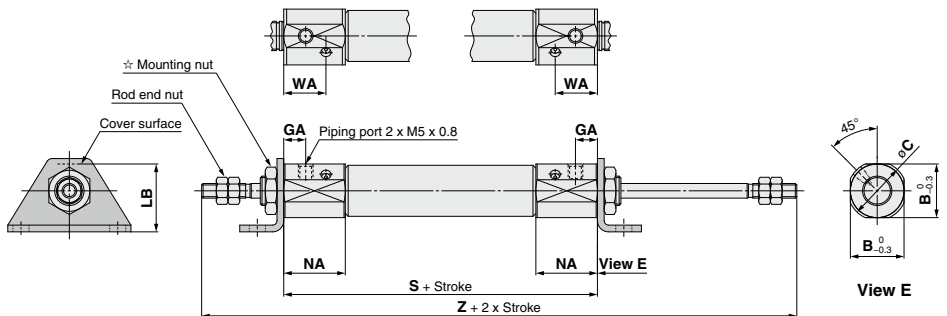

☆ For details of the mounting nut, refer to page 91.

	[mm]																					
Bore size	A	B	C	D	F	GA	H	LB	LC	LH	LT	LX	LY	LZ	MM	NA	NN	S	T	X	Y	Z
6	15	12	14	3	8	14.5	28	15	4.5	9	1.6	24	16.5	32	M3 x 0.5	16	M6 x 1.0	61 (66)	3	5	7	117 (122)
10	15	12	14	4	8	8	28	15	4.5	9	1.6	24	16.5	32	M4 x 0.7	12.5	M8 x 1.0	49	—	5	7	105
16	15	18.3	20	5	8	8	28	23	5.5	14	2.3	33	25	42	M5 x 0.8	12.5	M10 x 1.0	50	—	6	9	106

With Air Cushion Dimensions other than the table below are the same as the table above.

Bore size	B	C	GA	LB	NA	S	Z
10	15	17	7.5	16.5	21	14.4	66
16	18.3	20	7.5	23	21	14.4	67

☆: () in S and Z dimensions: With auto switch

CJ2W Series

Flange (F)

CJ2WF6 – Stroke Z

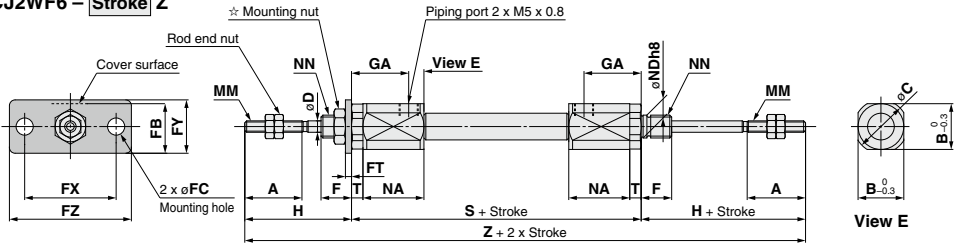

CJ2WF 10/16 – Stroke Z

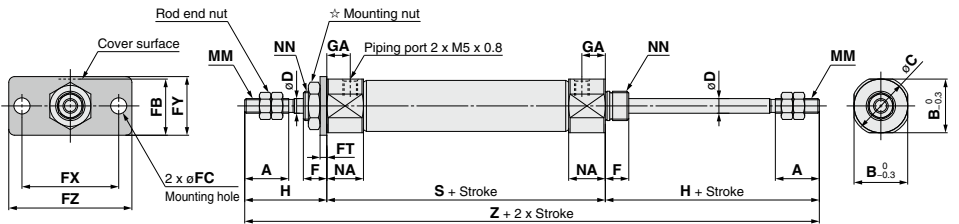

With air cushion: CJ2WF 10/16 – Stroke AZ

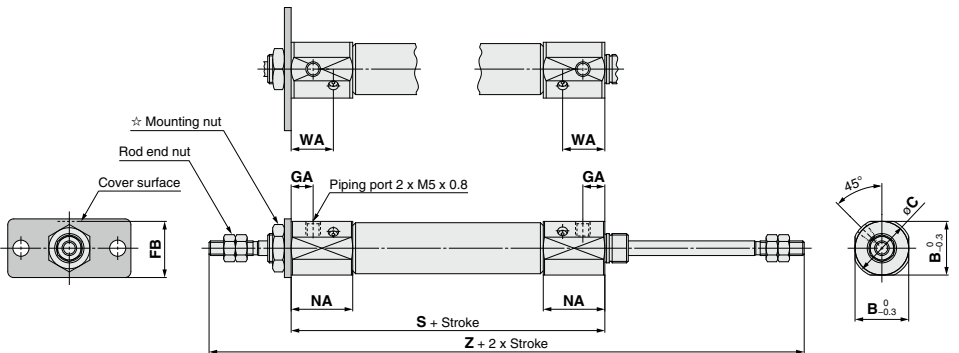

☆ For details of the mounting nut, refer to page 91.

Bore size	A	B	C	D	F	FB	FC	FT	FX	FY	FZ	GA	H	MM	NA	NN	S	T	Z
6	15	12	14	3	8	13	4.5	1.6	24	14	32	14.5	28	M3 x 0.5	16	M6 x 1.0	61 (66)	3	117 (122)
10	15	12	14	4	8	13	4.5	1.6	24	14	32	8	28	M4 x 0.7	12.5	M8 x 1.0	49	—	105
16	15	18.3	20	5	8	19	5.5	2.3	33	20	42	8	28	M5 x 0.8	12.5	M10 x 1.0	50	—	106

With Air Cushion Dimensions other than the table below are the same as the table above.

Bore size	B	C	GA	FB	NA	WA	S	Z
10	15	17	7.5	14.5	21	14.4	66	122
16	18.3	20	7.5	19	21	14.4	67	123

☆: () in S and Z dimensions: With auto switch

Air Cylinder: Standard Type Single Acting, Spring Return/Extend

CJ2 Series

ø6, ø10, ø16

RoHS



How to Order

With auto switch

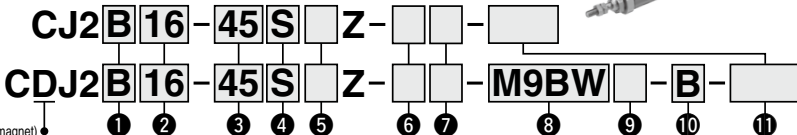

With auto switch (Built-in magnet)

1 Mounting

B	Basic
E	Double-side bossed
D**	Double clevis
L	Single foot
M	Double foot
F	Rod flange
G	Head flange

*: Foot/Flange brackets are shipped together with the product, but not assembled.

*: Double clevis is only available for ø10 and ø16.

*: Refer to page 182 for the double clevis (with one-touch connecting pin).

8 Auto switch

Nil	Without auto switch
------------	---------------------

*: For applicable auto switches, refer to the table below.

★ Enter the auto switch mounting type (A or B) even when a built-in magnet cylinder without an auto switch is required.

2 Bore size

6	6 mm
10	10 mm
16	16 mm

5 Head cover port location

Nil	Perpendicular to axis	
R	Axial	

*: For double clevis, the product is perpendicular to the cylinder axis.

*: For double-side bossed, the product is perpendicular to the cylinder axis.

*: Not applicable to single acting, spring extend (T).

3 Cylinder standard stroke [mm]

Refer to "Standard Strokes" on page 102.

6 Pivot bracket

Nil	None
N	Pivot bracket is shipped together with the product.

*: Only for the double clevis type (ø10 and ø16)

*: Pivot bracket is shipped together with the product, but not assembled.

10 Auto switch mounting type

A	Rail mounting
B	Band mounting

*: For rail mounting, screws and nuts for 2 auto switches come with the rail.

*: Refer to page 178 for auto switch mounting brackets.

*: ø6: Band mounting only

4 Action

S	Single acting, Spring return
T	Single acting, Spring extend

7 Rod end bracket

Nil	None
V	Single knuckle joint
W**	Double knuckle joint
T	Rod end cap (Flat type)
U	Rod end cap (Round type)

*: Rod end bracket is shipped together with the product, but not assembled.

*: Single/Double knuckle joint: ø10 and ø16 only

*: Refer to page 91 for the double knuckle joint (with one-touch connecting pin).

11 Made to Order

Refer to page 102 for details.

*: Refer to "Ordering Example of Cylinder Assembly" on page 102.

Applicable Auto Switches/Refer to pages 1271 to 1365 for further information on auto switches.

Type	Special function	Electrical entry	Indicating light	Wiring (Output)	Load voltage		Auto switch model				Lead wire length [m]					Pre-wired connector	Applicable load		
					DC	AC	Band mounting		Rail mounting		0.5 (Nil)	1 (M)	3 (L)	5 (Z)	None (N)				
							Perpendicular	In-line	Perpendicular	In-line									
Solid state auto switch	—	Grommet	No	3-wire (NPN)	5 V, 12 V	—	M9NV	M9N	M9NV	M9N	●	●	●	○	○	IC circuit	—		
				3-wire (PNP)			M9PV	M9P	M9PV	M9P	●	●	●	○	○				
		Connector	No	2-wire			M9BV	M9B	M9BV	M9B	●	●	●	○	○				
				—			H7C	J79C	—	●	—	●	●	—	—				
	Diagnostic indication (2-color indicator)	Grommet	Yes	3-wire (NPN)	24 V	—	M9NVV	M9NW	M9NVV	M9NW	●	●	●	○	○	IC circuit	Relay, PLC		
				3-wire (PNP)			M9PVV	M9PW	M9PVV	M9PW	●	●	●	○	○				
		Connector	Yes	2-wire			M9BWW	M9BW	M9BWW	M9BW	●	●	●	○	○				
				—			H7C	J79C	—	●	—	●	●	—	—				
		Grommet	No	3-wire (NPN)			M9NAV ^{*1}	M9NA ^{*1}	M9NAV ^{*1}	M9NA ^{*1}	○	○	●	○	○			IC circuit	—
				3-wire (PNP)			M9PAV ^{*1}	M9PA ^{*1}	M9PAV ^{*1}	M9PA ^{*1}	○	○	●	○	○				
Connector	No	2-wire	M9BAV ^{*1}	M9BA ^{*1}	M9BAV ^{*1}	M9BA ^{*1}	○	○	●	○	○								
		—	H7NF	—	F79F	—	●	—	●	●	—	—							
Reed auto switch	—	Grommet	Yes	3-wire (NPN equivalent)	24 V	12 V	A96V	A96	A96V	A96	●	—	●	—	—	IC circuit	—		
							—	—	A72	A72H	●	—	●	—	—				
							—	—	A93V ^{*2}	A93	A93V ^{*2}	A93	●	●	●			—	—
							—	—	A90V	A90	A90V	A90	●	—	●			—	—
		Connector	No	2-wire			100 V or less	A90V	A90	A90V	A90	●	—	●	—	—	IC circuit	Relay, PLC	
							—	—	C73C	A73C	—	●	—	●	●	—			—
							24 V or less	—	C80C	A80C	—	●	—	●	●	—			—
							—	—	A79W	—	—	●	—	●	●	—			—

*1: Water resistant type auto switches can be mounted on the above models, but in such case SMC cannot guarantee water resistance.

Please contact SMC regarding water resistant types with the above model numbers.

*2: 1 m type lead wire is only applicable to D-A93.

*: Lead wire length symbols: 0.5 m..... Nil (Example) M9NW 5 m..... Z (Example) M9NWZ
 1 m..... M (Example) M9NWM None..... N (Example) H7CN
 3 m..... L (Example) M9NWL

*: Since there are other applicable auto switches than listed, refer to page 179 for details.

*: Solid state auto switches marked with "○" are produced upon receipt of order.

*: The D-A93/M9C/A7C/A80C/F7C/J7C auto switches are shipped together, but not assembled. (For band mounting, only auto switch mounting brackets are assembled before being shipped.)

CJ2 Series

Spring extend



Spring return



Symbol

Single acting, Spring return,
Rubber bumper

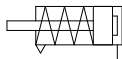

Single acting, Spring extend,
Rubber bumper

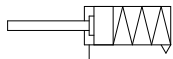

Made to Order: Individual Specifications
(For details, refer to pages 180 and 182.)

Symbol	Specifications
-X446	PTFE grease
-X773*1	Short pitch mounting/Single acting, spring return
-X2838*2	Double clevis (With one-touch connecting pin)

*1: ø6 only

*2: ø10 and ø16 only

Made to Order

[Click here for details](#)

Symbol	Specifications
-XA <input type="checkbox"/>	Change of rod end shape
-XC22	Fluororubber seal
-XC51	With hose nipple
-XC85	Grease for food processing equipment

Refer to pages 172 to 179 for cylinders with auto switches.

- Auto switch proper mounting position (detection at stroke end) and its mounting height
- Minimum stroke for auto switch mounting
- Operating range
- Auto switch mounting brackets/Part no.

⚠ Precautions

Refer to page 183 before handling.

Ordering Example of Cylinder Assembly

Cylinder model: CDJ2D16-45SZ-NW-M9BW-B

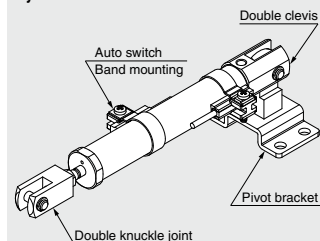

Mounting D: Double clevis
Pivot bracket N: Yes
Rod end bracket W: Double knuckle joint
Auto switch D-M9BW: 2 pcs.
Auto switch mounting B: Band mounting

*: Pivot bracket, double knuckle joint and auto switch are shipped together with the product, but not assembled.

Specifications

Bore size [mm]		6	10	16
Action		Single acting, Spring return/Single acting, Spring extend		
Fluid		Air		
Proof pressure		1 MPa		
Maximum operating pressure		0.7 MPa		
Minimum operating pressure	Spring return	0.2 MPa	0.15 MPa	
	Spring extend	0.25 MPa	0.15 MPa	
Ambient and fluid temperature		Without auto switch: -10°C to 70°C (No freezing) With auto switch: -10°C to 60°C		
Cushion		Rubber bumper		
Lubrication		Not required (Non-lube)		
Stroke length tolerance		+1.0 0		
Piston speed		50 to 750 mm/s		
Allowable kinetic energy		0.012 J	0.035 J	0.090 J

Standard Strokes

Bore size	Standard stroke [mm]
6	15, 30, 45, 60
10	15, 30, 45, 60
16	15, 30, 45, 60, 75, 100, 125, 150

*: Manufacture of intermediate strokes in 1 mm increments is possible. (Spacers are not used.)

*: Please consult with SMC for strokes which exceed the standard stroke length.

*: Applicable strokes should be confirmed according to the usage. For details, refer to "Air Cylinders Model Selection" on pages 8 to 10. In addition, the products that exceed the standard stroke might not be able to fulfill the specifications due to the deflection etc.

Spring Reaction Force

Refer to page 1571 (Table (2): Spring Reaction Force).

Mounting Brackets/Part No.

Mounting bracket	Bore size [mm]		
	6	10	16
Foot	CJ-L006C	CJ-L010C	CJ-L016C
Flange	CJ-F006C	CJ-F010C	CJ-F016C
Pivot bracket (T-bracket)*1	—	CJ-T010C	CJ-T016C

*1: The pivot bracket (T-bracket) is used with double clevis (D).

Mounting and Accessories

Refer to page 88 for the list of brackets and page 91 for details about part numbers and dimensions.

●...Mounted on the product. ○...Can be ordered within the cylinder model. △...Order separately.

Mounting	Bore size [mm]				
	6	10	16	10	16
Mounting nut	●	●	●	—	—
Rod end nut	●	●	●	●	●
Clevis pin (including retaining rings)	—	—	—	●	●
Double clevis (With one-touch connecting pin)	△	△	△	○ (-X2838)	○ (-X2838)
Single knuckle joint	○	○	○	○	○
Double knuckle joint (including a pin and retaining rings)	○	○	○	○	○
Double knuckle joint (With one-touch connecting pin)	△	△	△	△	△
Rod end cap (Flat/Round type)	○	○	○	○	○
Pivot bracket (T-bracket)	—	—	—	○	●

Note 1) Double clevis is only available for ø10 and ø16.

Note 2) Stainless steel mounting brackets and accessories are also available.

Refer to page 92 for details.

Theoretical Output

Refer to the "Single acting, Spring return cylinder" in Theoretical Output of Technical data 3 in page 1575. In the case of the spring extend type, the force at OUT side will be the ending force of the spring return, and that at the IN side will be the amount of the IN side force of the double acting type cylinder from which the beginning force of the spring return has been subtracted.

Moisture Control Tube IDK Series

When operating an actuator with a small diameter and a short stroke at a high frequency, the dew condensation (water droplet) may occur inside the piping depending on the conditions.

Simply connecting the moisture control tube to the actuator will prevent dew condensation from occurring. For details, refer to the [Web Catalog](#).

Weights

Spring Return

[g]

Bore size [mm]		6			10				16				
Mounting		Basic	Axial piping	Double-side bossed	Basic	Axial piping	Double clevis (including clevis pin)	Double-side bossed	Basic	Axial piping	Double clevis (including clevis pin)	Double-side bossed	
Basic weight	15 stroke	17	15	18	28	28	29	28	62	62	69	64	
	30 stroke	20	18	21	35	35	35	35	77	77	84	79	
	45 stroke	23	21	23	44	44	45	45	95	95	102	97	
	60 stroke	26	24	27	54	54	55	54	113	113	119	115	
	75 stroke	/				/				134	134	141	136
	100 stroke									167	167	174	169
	125 stroke									204	204	212	206
150 stroke	227									227	234	229	
Mounting bracket weight	Single foot	8	8	8	8				25				
	Double foot	16	16	16	16				50				
	Rod flange	5	5	5	5				13				
	Head flange	5	5	5	5				13				
	Clevis pin	—	—	—	—	—	1	—	—	—	3	—	
Accessories	One-touch connecting pin for double clevis	—	—	—	—	—	2	—	—	—	4	—	
	Single knuckle joint	—	—	—	17				23				
	Double knuckle joint (including knuckle pin)	—	—	—	25				21				
	Double knuckle joint (With one-touch connecting pin)	—	—	—	26				22				
	Rod end cap (Flat type)	1	1	1	1				2				
	Rod end cap (Round type)	1	1	1	1				2				
	Pivot Bracket (T-bracket)	—	—	—	32				50				

*: Mounting nut and rod end nut are included in the basic weight.

*: Mounting nut is not attached to the double clevis, so the mounting nut weight is already subtracted.

Calculation:

Example) **CJ2L10-45SZ**

•Basic weight 44 (ø10-45 stroke)

•Mounting bracket weight..... 8 (Single foot)

44 + 8 = 52 g

Spring Extend

[g]

Bore size [mm]		6		10				16					
Mounting		Basic	Double-side bossed	Basic	Axial piping	Double clevis (including clevis pin)	Double-side bossed	Basic	Axial piping	Double clevis (including clevis pin)	Double-side bossed		
Basic weight	15 stroke	18	19	28	28	30	29	63	63	71	67		
	30 stroke	21	22	34	34	36	35	77	77	85	80		
	45 stroke	24	24	42	42	44	43	93	93	100	96		
	60 stroke	27	28	51	51	52	51	109	109	116	112		
	75 stroke	/				/				129	129	137	133
	100 stroke									159	159	166	162
	125 stroke									193	193	201	196
150 stroke	213									213	221	217	
Mounting bracket weight	Single foot	8	8	8				25					
	Double foot	16	16	16				50					
	Rod flange	5	5	5				13					
	Head flange	5	5	5				13					
	Clevis pin	—	—	—	—	1	—	—	—	3	—		
Accessories	One-touch connecting pin for double clevis	—	—	—	—	2	—	—	—	4	—		
	Single knuckle joint	—	—	17				23					
	Double knuckle joint (including knuckle pin)	—	—	25				21					
	Double knuckle joint (With one-touch connecting pin)	—	—	26				22					
	Rod end cap (Flat type)	1	1	1				2					
	Rod end cap (Round type)	1	1	1				2					
	Pivot Bracket (T-bracket)	—	—	32				50					

*: Mounting nut and rod end nut are included in the basic weight.

*: Mounting nut is not attached to the double clevis, so the mounting nut weight is already subtracted.

Calculation:

Example) **CJ2L10-45TZ**

•Basic weight 42 (ø10-45 stroke)

•Mounting bracket weight..... 8 (Single foot)

42 + 8 = 50 g

CJ2 Series

Construction (Not able to disassemble)

Single acting, Spring return

ø6

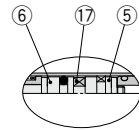
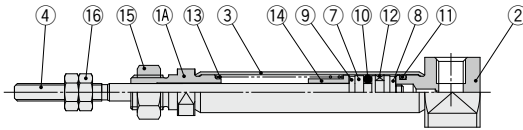

With auto switch

ø10, ø16

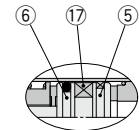
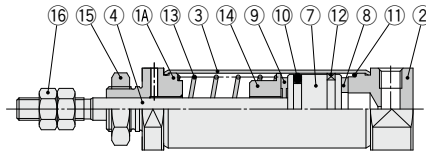

With auto switch

Single acting, Spring extend

ø6

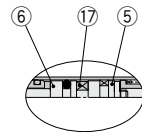
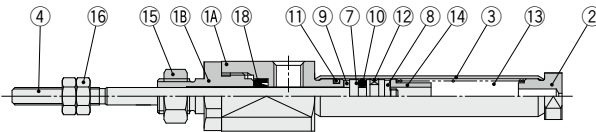

With auto switch

ø10, ø16

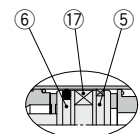
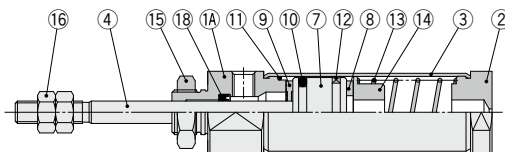

With auto switch

Component Parts

No.	Description	Material	Note
1A	Rod cover	Aluminum alloy	
1B	Seal retainer	Aluminum alloy	ø6 only
2	Head cover	Aluminum alloy	
3	Cylinder tube	Stainless steel	
4	Piston rod	Stainless steel	
5	Piston A	Aluminum alloy	
6	Piston B	Aluminum alloy	
7	Piston	Aluminum alloy	
8	Bumper A	Urethane	
9	Bumper B	Urethane	

No.	Description	Material	Note
10	Piston seal	NBR	
11	Tube gasket	NBR	
12	Wear ring	Resin	
13	Return spring	Piano wire	
14	Spring seat	Aluminum alloy	
15	Mounting nut	Rolled steel	
16	Rod end nut	Rolled steel	
17	Magnet	—	
18	Rod seal	NBR	

Single Acting, Spring Return: Basic (B)

CJ2B6 – Stroke S Head cover port location Z

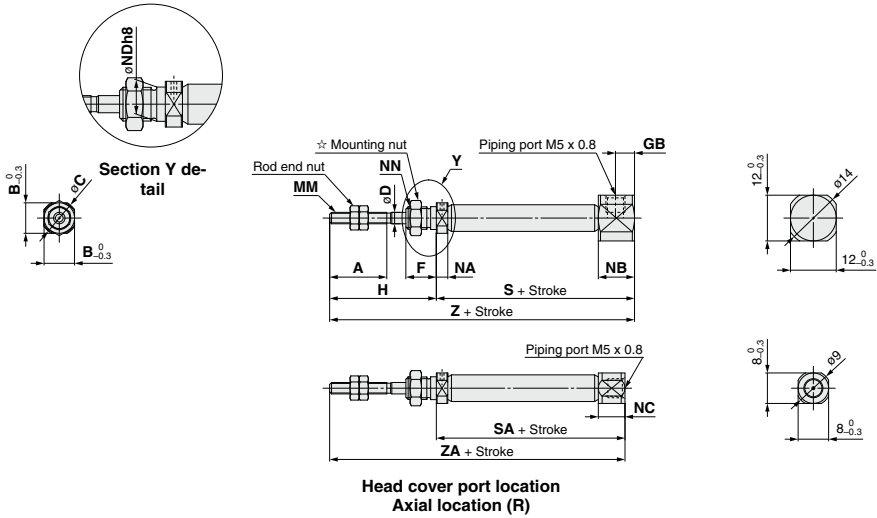

CJ2B 10/16 – Stroke S Head cover port location Z

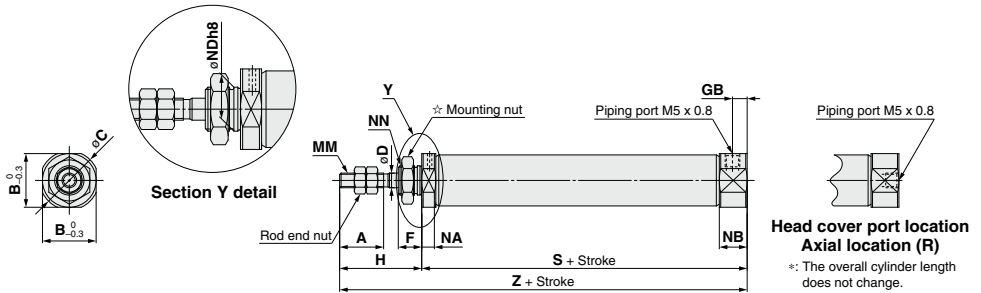

☆ For details of the mounting nut, refer to page 91.

Bore size	S																Z																ZA															
	A	B	C	D	F	GB	H	MM	NA	NB	NC	NDh8	NN	5 to 15 st	16 to 30 st	31 to 45 st	46 to 60 st	61 to 75 st	76 to 100 st	101 to 125 st	126 to 150 st	5 to 15 st	16 to 30 st	31 to 45 st	46 to 60 st	61 to 75 st	76 to 100 st	101 to 125 st	126 to 150 st	5 to 15 st	16 to 30 st	31 to 45 st	46 to 60 st	61 to 75 st	76 to 100 st	101 to 125 st	126 to 150 st											
6	15	8	9	3	8	5	28	M3 x 0.5	3	9.5	7	6 ^{-0.016}	M6 x 1.0	37	46	(51)	50	64	(69)	—	—	—	—	37	46	(51)	50	64	(69)	—	—	—	—	37	46	(51)	50	64	(69)	—	—	—	—					
10	15	12	14	4	8	5	28	M4 x 0.7	4.8	9.5	—	8 ^{-0.022}	M8 x 1.0	45.5	53	65	77	—	—	—	—	—	—	45.5	53	65	77	—	—	—	—	—	—	45.5	53	65	77	—	—	—	—	—	—					
16	15	18.3	20	5	8	5	28	M5 x 0.8	4.8	9.5	—	10 ^{-0.022}	M10 x 1.0	45.5	54	66	78	84	108	126	138	—	—	45.5	54	66	78	84	108	126	138	—	—	45.5	54	66	78	84	108	126	138	—	—					

☆: () in S, SA, Z and ZA dimensions: With auto switch

CJ2 Series

Single Acting, Spring Return: Double-side Bossed (E)

CJ2E6 – Stroke SZ

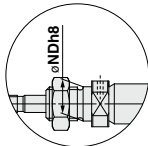

Section Y detail

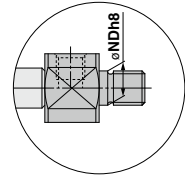

Section YY detail

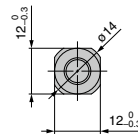
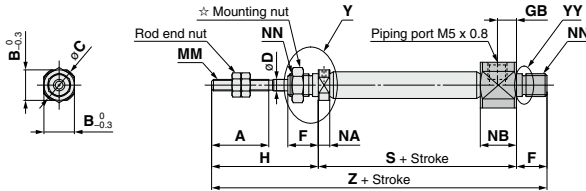

CJ2E 10/16 – Stroke SZ

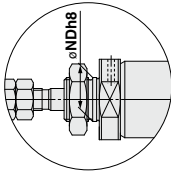

Section Y detail

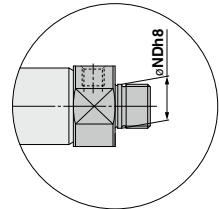

Section YY detail

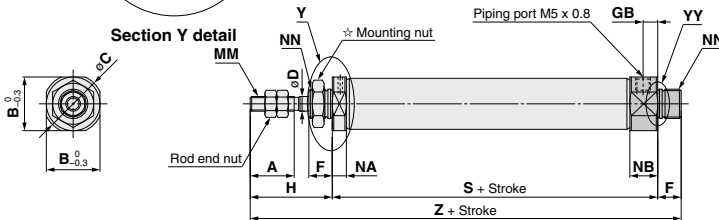

☆ For details of the mounting nut, refer to page 91.

Bore size	A	B	C	D	F	GB	H	MM	NA	NB	NDh8	NN	S												Z											
													5 to 15 st	16 to 30 st	31 to 45 st	46 to 60 st	61 to 75 st	76 to 100 st	101 to 125 st	126 to 150 st	5 to 15 st	16 to 30 st	31 to 45 st	46 to 60 st	61 to 75 st	76 to 100 st	101 to 125 st	126 to 150 st								
6	15	8	9	3	8	5	28	M3 x 0.5	3	9.5	6 ^{0.018}	M6 x 1.0	37 (42)	46 (51)	50 (55)	64 (69)	—	—	—	—	—	—	73 (78)	82 (87)	86 (91)	100 (105)	—	—	—	—	—	—	—	—		
10	15	12	14	4	8	5	28	M4 x 0.7	4.8	9.5	8 ^{0.022}	M8 x 1.0	45.5	53	65	77	—	—	—	—	—	—	81.5	89	101	113	—	—	—	—	—	—	—	—	—	
16	15	18.3	20	5	8	5	28	M5 x 0.8	4.8	9.5	10 ^{0.022}	M10 x 1.0	45.5	54	66	78	84	108	126	138	138	81.5	90	102	114	120	144	162	174	—	—	—	—	—	—	—

※: () in S and Z dimensions: With auto switch

Single Acting, Spring Return: Single Foot (L)

CJ2L6 – Stroke S Head cover port location Z

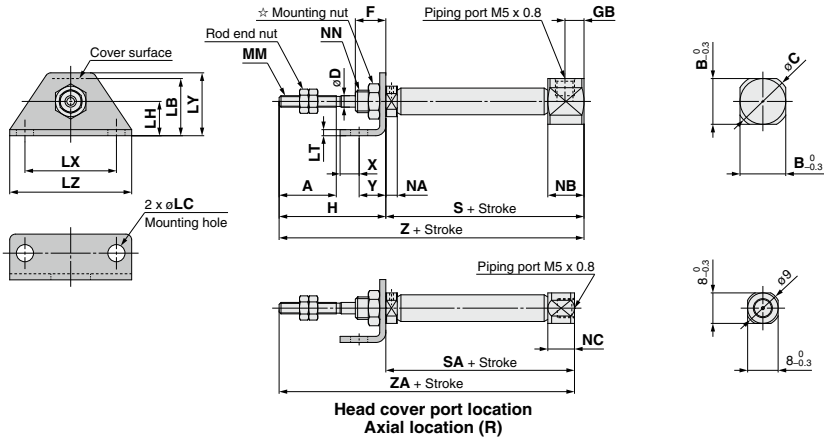

CJ2L $\frac{10}{16}$ – Stroke S Head cover port location Z

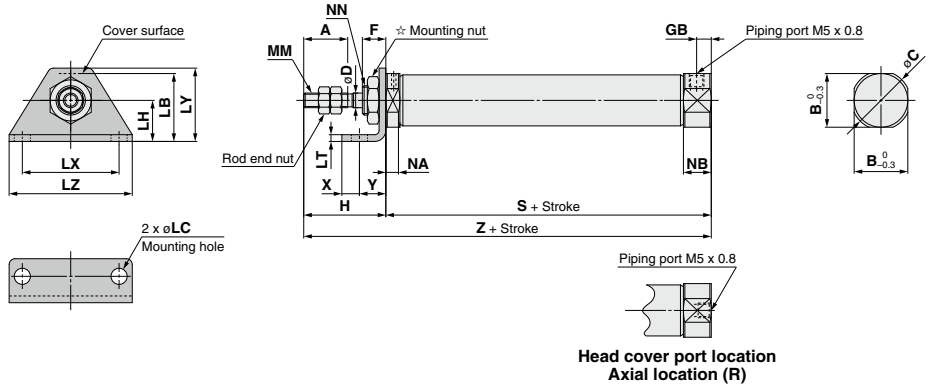

※: The overall cylinder length does not change.

☆ For details of the mounting nut, refer to page 91.

Bore size																	S											
	A	B	C	D	F	GB	H	LB	LC	LH	LT	LX	LY	LZ	MM	NA	NB	NN	5 to 15 st	16 to 30 st	31 to 45 st	46 to 60 st	61 to 75 st	76 to 100 st	101 to 125 st	126 to 150 st		
6	15	12	14	3	8	5	28	13	4.5	9	1.6	24	16.5	32	M3 x 0.5	3	9.5	M6 x 1.0	37	46	50	64	—	—	—	—		
																			(42)	(51)	(55)	(69)	—	—	—	—		
10	15	12	14	4	8	5	28	15	4.5	9	1.6	24	16.5	32	M4 x 0.7	4.8	9.5	M8 x 1.0	45.5	53	65	77	—	—	—	—		
16	15	18.3	20	5	8	5	28	23	5.5	14	2.3	33	25	42	M5 x 0.8	4.8	9.5	M10 x 1.0	45.5	54	66	78	84	108	126	138		

Bore size	SA												Z												ZA											
	5 to 15 st	16 to 30 st	31 to 45 st	46 to 60 st	61 to 75 st	76 to 100 st	101 to 125 st	126 to 150 st	X	Y	5 to 15 st	16 to 30 st	31 to 45 st	46 to 60 st	61 to 75 st	76 to 100 st	101 to 125 st	126 to 150 st	5 to 15 st	16 to 30 st	31 to 45 st	46 to 60 st	61 to 75 st	76 to 100 st	101 to 125 st	126 to 150 st										
6	34.5	43.5	47.5	61.5	—	—	—	—	5	7	65	74	78	92	—	—	—	—	62.5	71.5	75.5	89.5	—	—	—	—										
	(39.5)	(48.5)	(52.5)	(66.5)	—	—	—	—	—	—	(70)	(79)	(83)	(97)	—	—	—	—	(67.5)	(76.5)	(80.5)	(94.5)	—	—	—	—										
10	—	—	—	—	—	—	—	—	5	7	73.5	81	93	105	—	—	—	—	—	—	—	—	—	—	—	—										
16	—	—	—	—	—	—	—	—	6	9	73.5	82	94	106	112	136	154	166	—	—	—	—	—	—	—	—										

※: () in S, SA, Z and ZA dimensions: With auto switch

CJ2 Series

Single Acting, Spring Return: Double Foot (M)

CJ2M6 – Stroke SZ

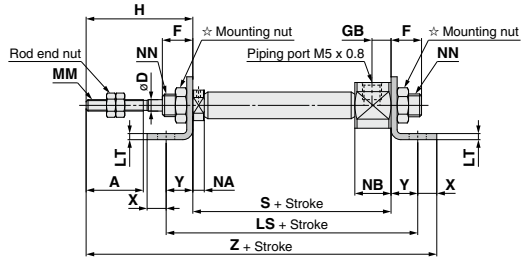
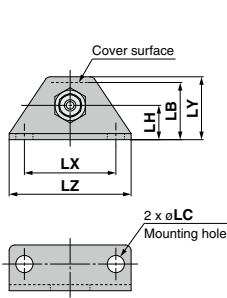

CJ2M ¹⁰/₁₆ – Stroke SZ

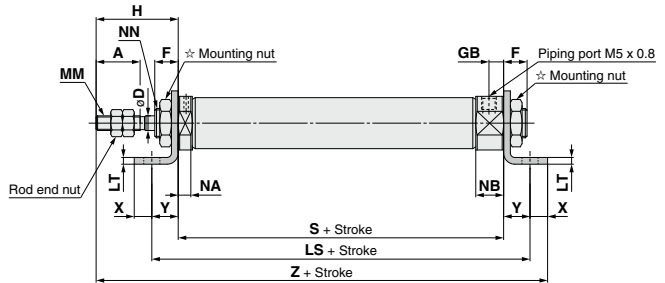
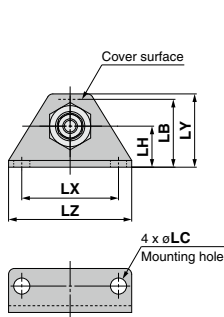

☆ For details of the mounting nut, refer to page 91.

Bore size	A	D	F	GB	H	LB	LC	LH	LS								LT	LX	LY	LZ	MM	NA
									5 to 15 st	16 to 30 st	31 to 45 st	46 to 60 st	61 to 75 st	76 to 100 st	101 to 125 st	126 to 150 st						
6	15	3	8	5	28	13	4.5	9	51 (56)	60 (65)	64 (69)	78 (83)	—	—	—	—	1.6	24	16.5	32	M3 x 0.5	3
10	15	4	8	5	28	15	4.5	9	59.5	67	79	91	—	—	—	—	1.6	24	16.5	32	M4 x 0.7	4.8
16	15	5	8	5	28	23	5.5	14	63.5	72	84	96	102	126	144	156	2.3	33	25	42	M5 x 0.8	4.8

Bore size	NB	NN	S								X	Y	Z										
			5 to 15 st	16 to 30 st	31 to 45 st	46 to 60 st	61 to 75 st	76 to 100 st	101 to 125 st	126 to 150 st			5 to 15 st	16 to 30 st	31 to 45 st	46 to 60 st	61 to 75 st	76 to 100 st	101 to 125 st	126 to 150 st			
6	9.5	M6 x 1.0	37 (42)	46 (51)	50 (55)	64 (69)	—	—	—	—	5	7	77 (82)	86 (91)	90 (95)	104 (109)	—	—	—	—	—	—	—
10	9.5	M8 x 1.0	45.5	53	65	77	—	—	—	—	5	7	85.5	93	105	117	—	—	—	—	—	—	
16	9.5	M10 x 1.0	45.5	54	66	78	84	108	126	138	6	9	88.5	97	109	121	127	151	169	181	—	—	

*: () in LS, S and Z dimensions: With auto switch

Single Acting, Spring Return: Rod Flange (F)

CJ2F6 – Stroke S Head cover port location Z

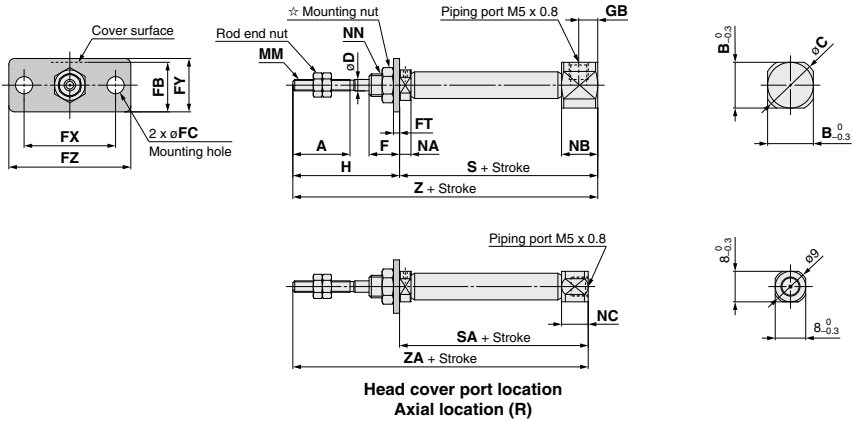

CJ2F 10/16 – Stroke S Head cover port location Z

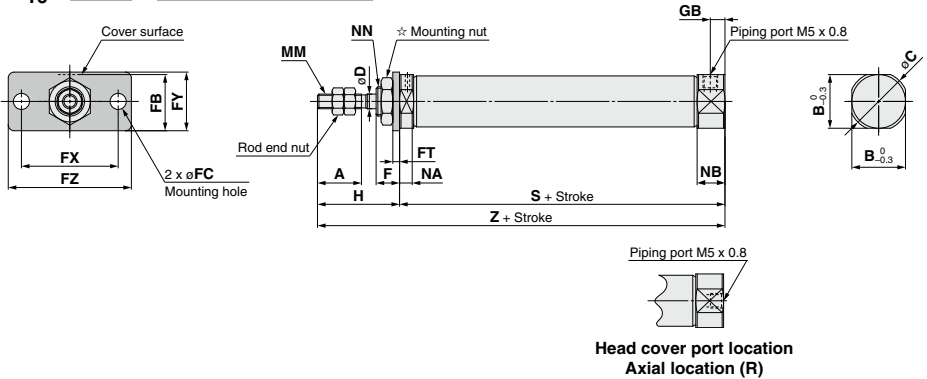

*: The overall cylinder length does not change.

☆ For details of the mounting nut, refer to page 91.

Bore size	S													Z												ZA																
	A	B	C	D	F	FB	FC	FT	FX	FY	FZ	GB	H	MM	NA	NB	NC	NN	5 to 15 st	16 to 30 st	31 to 45 st	46 to 60 st	61 to 75 st	76 to 100 st	101 to 125 st	126 to 150 st	5 to 15 st	16 to 30 st	31 to 45 st	46 to 60 st	61 to 75 st	76 to 100 st	101 to 125 st	126 to 150 st	5 to 15 st	16 to 30 st	31 to 45 st	46 to 60 st	61 to 75 st	76 to 100 st	101 to 125 st	126 to 150 st
6	15	12	14	3	8	11	4.5	1.6	24	14	32	5	28	M3 x 0.5	3	9.5	7	M6 x 1.0	37 (42)	46 (51)	50 (55)	64 (69)	—	—	—	—	—	—	—	—	—	—	—	—	—	—	—	—	—	—	—	—
10	15	12	14	4	8	13	4.5	1.6	24	14	32	5	28	M4 x 0.7	4.8	9.5	—	M8 x 1.0	45.5	53	65	77	—	—	—	—	—	—	—	—	—	—	—	—	—	—	—	—	—	—	—	—
16	15	18.3	20	5	8	19	5.5	2.3	33	20	42	5	28	M5 x 0.8	4.8	9.5	—	M10 x 1.0	45.5	54	66	78	84	108	126	138	—	—	—	—	—	—	—	—	—	—	—	—	—	—	—	—

*: () in S, SA, Z and ZA dimensions: With auto switch

CJ2 Series

Single Acting, Spring Return: Head Flange (G)

CJ2G6 – Stroke SZ

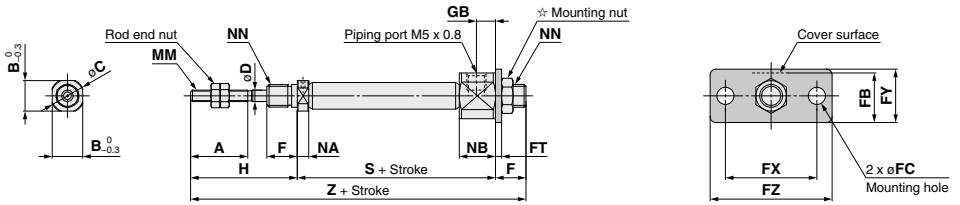

CJ2G $\frac{10}{16}$ – Stroke SZ

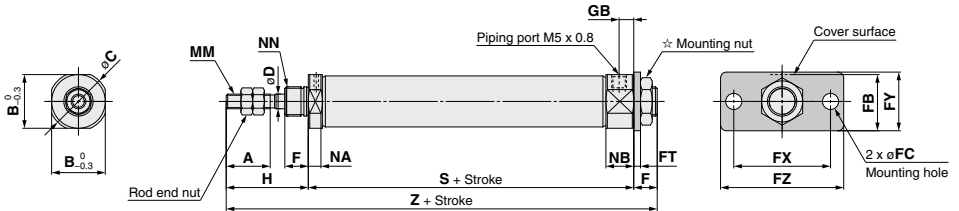

☆ For details of the mounting nut, refer to page 91.

[mm]

Bore size	A	B	C	D	F	FB	FC	FT	FX	FY	FZ	GB	H	MM	NA	NB	NN
6	15	8	9	3	8	11	4.5	1.6	24	14	32	5	28	M3 x 0.5	3	9.5	M6 x 1.0
10	15	12	14	4	8	13	4.5	1.6	24	14	32	5	28	M4 x 0.7	4.8	9.5	M8 x 1.0
16	15	18.3	20	5	8	19	5.5	2.3	33	20	42	5	28	M5 x 0.8	4.8	9.5	M10 x 1.0
Bore size	S											Z					
	5 to 15 st	16 to 30 st	31 to 45 st	46 to 60 st	61 to 75 st	76 to 100 st	101 to 125 st	126 to 150 st	5 to 15 st	16 to 30 st	31 to 45 st	46 to 60 st	61 to 75 st	76 to 100 st	101 to 125 st	126 to 150 st	
6	37 (42)	46 (51)	50 (55)	64 (69)	—	—	—	—	73 (78)	82 (87)	86 (91)	100 (105)	—	—	—	—	
10	45.5	53	65	77	—	—	—	—	81.5	89	101	113	—	—	—	—	
16	45.5	54	66	78	84	108	126	138	81.5	90	102	114	120	144	162	174	

☆: () in S and Z dimensions: With auto switch

Single Acting, Spring Return: Double Clevis (D)

CJ2D $\frac{10}{16}$ - Stroke SZ

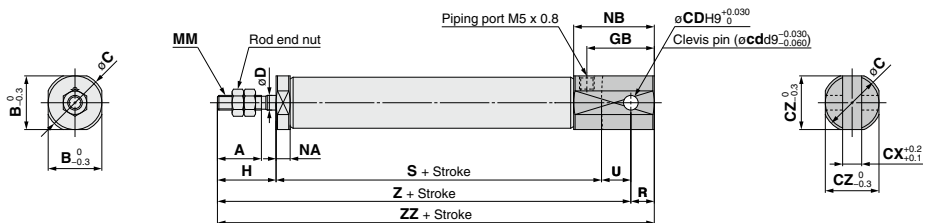

Bore size	A	B	C	CD (cd)	CX	CZ	D	GB	H	MM	NA	NB	R	U	S							
															5 to 15 st	16 to 30 st	31 to 45 st	46 to 60 st	61 to 75 st	76 to 100 st	101 to 125 st	126 to 150 st
10	15	12	14	3.3	3.2	12	4	18	20	M4 x 0.7	4.8	22.5	5	8	45.5	53	65	77	—	—	—	—
16	15	18.3	20	5	6.5	18.3	5	23	20	M5 x 0.8	4.8	27.5	8	10	45.5	54	66	78	84	108	126	138

Bore size	Z								ZZ							
	5 to 15 st	16 to 30 st	31 to 45 st	46 to 60 st	61 to 75 st	76 to 100 st	101 to 125 st	126 to 150 st	5 to 15 st	16 to 30 st	31 to 45 st	46 to 60 st	61 to 75 st	76 to 100 st	101 to 125 st	126 to 150 st
10	73.5	81	93	105	—	—	—	—	78.5	86	98	110	—	—	—	—
16	75.5	84	96	108	114	138	156	168	83.5	92	104	116	122	146	164	176

*: A clevis pin and retaining rings are included.

CJ2 Series

Single Acting, Spring Extend: Basic (B)

CJ2B6 – Stroke TZ

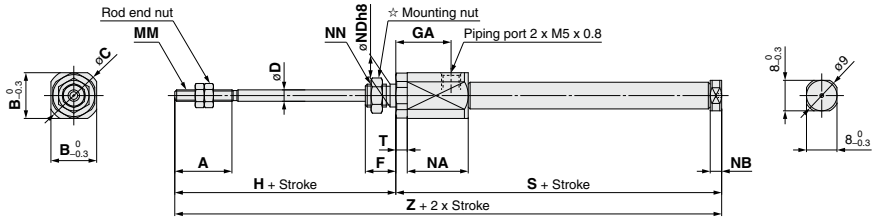

CJ2B $\frac{10}{16}$ – Stroke TZ

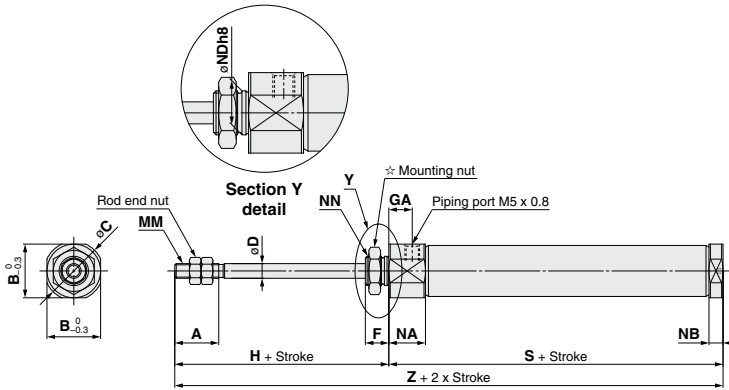

☆ For details of the mounting nut, refer to page 91.

Bore size	A	B	C	D	F	GA	H	MM	NA	NB	NDh8	NN	T	[mm]																				
														S						Z														
6	15	12	14	3	8	14.5	28	M3 x 0.5	16	3	6 $_{-0.018}^0$	M6 x 1.0	3	5 to 15 st	16 to 30 st	31 to 45 st	46 to 60 st	61 to 75 st	76 to 100 st	101 to 125 st	126 to 150 st	5 to 15 st	16 to 30 st	31 to 45 st	46 to 60 st	61 to 75 st	76 to 100 st	101 to 125 st	126 to 150 st					
10	15	12	14	4	8	8	28	M4 x 0.7	12.5	4.8	8 $_{-0.022}^0$	M8 x 1.0	—	46.5 (51.5)	55.5 (60.5)	59.5 (64.5)	73.5 (78.5)	—	—	—	—	74.5 (79.5)	83.5 (88.5)	87.5 (92.5)	101.5 (106.5)	—	—	—	—	—	—	—		
16	15	18.3	20	5	8	8	28	M5 x 0.8	12.5	4.8	10 $_{-0.022}^0$	M10 x 1.0	—	48.5	56	68	80	—	—	—	—	76.5	84	96	108	—	—	—	—	—	—	—	—	
6	15	18.3	20	5	8	8	28	M5 x 0.8	12.5	4.8	10 $_{-0.022}^0$	M10 x 1.0	—	48.5	57	69	81	87	111	129	141	76.5	85	97	109	115	139	157	169	—	—	—	—	—

*: () in S and Z dimensions: With auto switch

Single Acting, Spring Extend: Double-side Bossed (E)

CJ2E6 – Stroke TZ

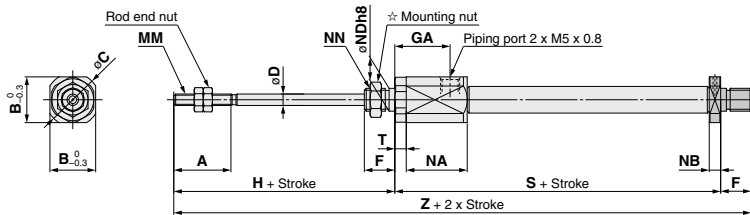

CJ2E 10/16 – Stroke TZ

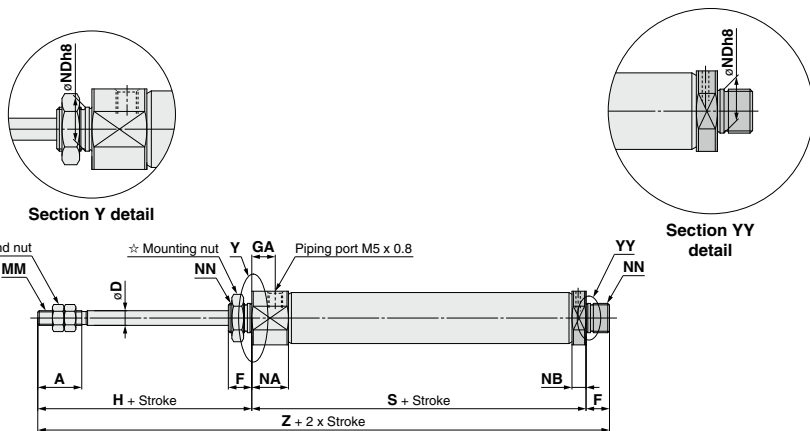

☆ For details of the mounting nut, refer to page 91.

[mm]

Bore size	A	B	C	D	F	GA	H	MM	NA	NB	Ndh8	NN
6	15	12	14	3	8	14.5	28	M3 x 0.5	16	3	6 ₀ ^{-0.018}	M6 x 1.0
10	15	12	14	4	8	8	28	M4 x 0.7	12.5	4.8	8 ₀ ^{-0.022}	M8 x 1.0
16	15	18.3	20	5	8	8	28	M5 x 0.8	12.5	4.8	10 ₀ ^{-0.022}	M10 x 1.0

Bore size	S								Z							
	5 to 15 st	16 to 30 st	31 to 45 st	46 to 60 st	61 to 75 st	76 to 100 st	101 to 125 st	126 to 150 st	5 to 15 st	16 to 30 st	31 to 45 st	46 to 60 st	61 to 75 st	76 to 100 st	101 to 125 st	126 to 150 st
6	46.5 (51.5)	55.5 (60.5)	59.5 (64.5)	73.5 (78.5)	—	—	—	—	82.5 (87.5)	91.5 (96.5)	95.5 (100.5)	109.5 (114.5)	—	—	—	—
10	48.5	56	68	80	—	—	—	—	84.5	92	104	116	—	—	—	—
16	48.5	57	69	81	87	111	129	141	84.5	93	105	117	123	147	165	177

☆: () in S and Z dimensions: With auto switch

CJ2 Series

Single Acting, Spring Extend: Single Foot (L)

CJ2L6 – Stroke TZ

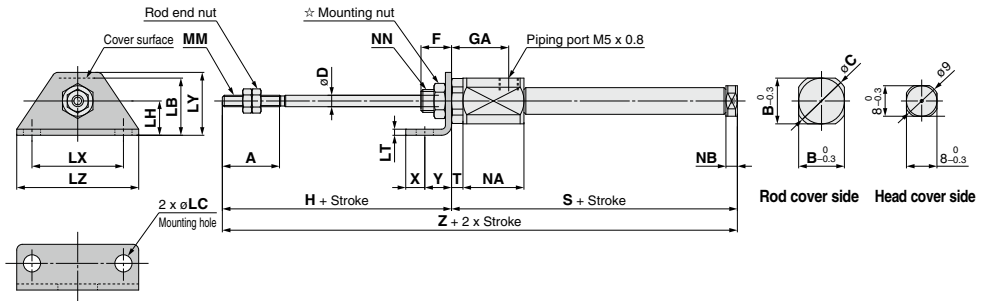

CJ2L 10/16 – Stroke TZ

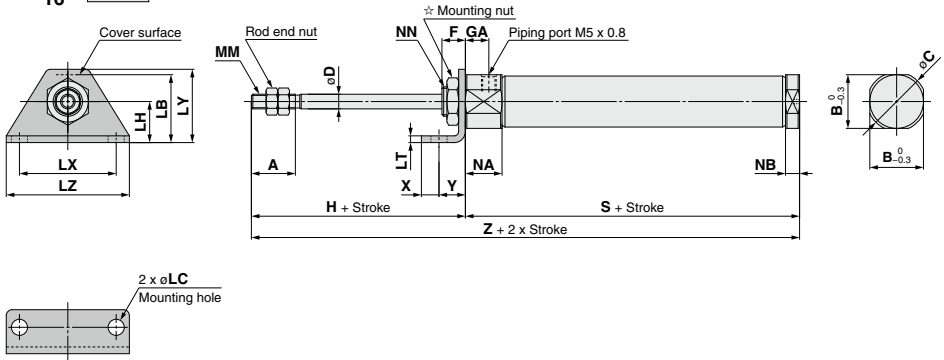

☆ For details of the mounting nut, refer to page 91.

[mm]

Bore size	A	B	C	D	F	GA	H	LB	LC	LH	LT	LX	LY	LZ	MM	NA	NB	NN	T
6	15	12	14	3	8	14.5	28	15	4.5	9	1.6	24	16.5	32	M3 x 0.5	16	3	M6 x 1.0	3
10	15	12	14	4	8	8	28	15	4.5	9	1.6	24	16.5	32	M4 x 0.7	12.5	4.8	M8 x 1.0	—
16	15	18.3	20	5	8	8	28	23	5.5	14	2.3	33	25	42	M5 x 0.8	12.5	4.8	M10 x 1.0	—

Bore size	S								X	Y	Z								
	5 to 15 st	16 to 30 st	31 to 45 st	46 to 60 st	61 to 75 st	76 to 100 st	101 to 125 st	126 to 150 st			5 to 15 st	16 to 30 st	31 to 45 st	46 to 60 st	61 to 75 st	76 to 100 st	101 to 125 st	126 to 150 st	
6	46.5 (51.5)	55.5 (60.5)	59.5 (64.5)	73.5 (78.5)	—	—	—	—	5	7	74.5 (79.5)	83.5 (88.5)	87.5 (92.5)	101.5 (106.5)	—	—	—	—	—
10	48.5	56	68	80	—	—	—	—	5	7	76.5	84	96	108	—	—	—	—	—
16	48.5	57	69	81	87	111	129	141	6	9	76.5	85	97	109	115	139	157	169	—

☆: () in S and Z dimensions: With auto switch

Single Acting, Spring Extend: Double Foot (M)

CJ2M6 – Stroke TZ

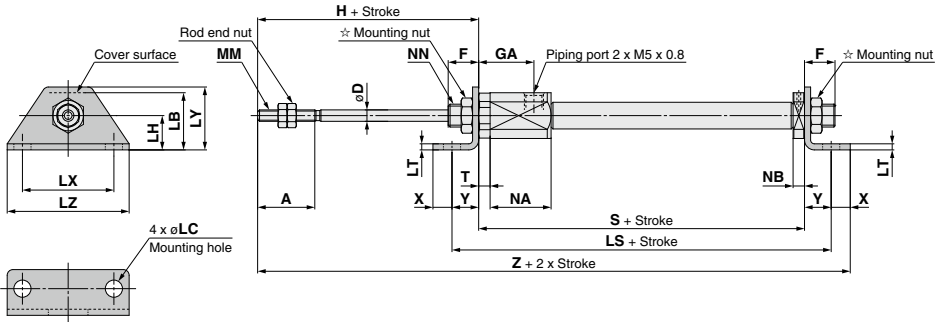

CJ2M ¹⁰/₁₆ – Stroke TZ

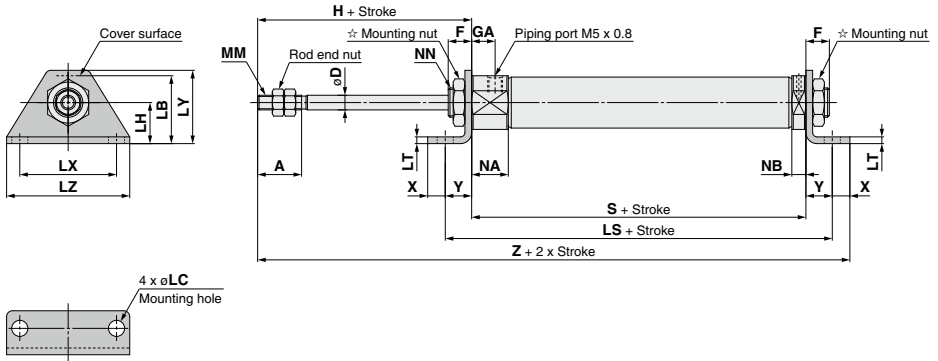

☆ For details of the mounting nut, refer to page 91.

Bore size	A	D	F	GA	H	LB	LC	LH	LS								LT	LX	LY	LZ	MM
									5 to 15 st	16 to 30 st	31 to 45 st	46 to 60 st	61 to 75 st	76 to 100 st	101 to 125 st	126 to 150 st					
6	15	3	8	14.5	28	15	4.5	9	60.5	69.5	73.5	87.5	—	—	—	—	1.6	24	16.5	32	M3 x 0.5
10	15	4	8	8	28	15	4.5	9	62.5	70	82	94	—	—	—	—	1.6	24	16.5	32	M4 x 0.7
16	15	5	8	8	28	23	5.5	14	66.5	75	87	99	105	129	147	159	2.3	33	25	42	M5 x 0.8

Bore size	NA	NB	NN	S								X	Y	Z									
				5 to 15 st	16 to 30 st	31 to 45 st	46 to 60 st	61 to 75 st	76 to 100 st	101 to 125 st	126 to 150 st			151 to 175 st	176 to 200 st	201 to 225 st	226 to 250 st						
6	16	3	M6 x 1.0	46.5	55.5	59.5	73.5	—	—	—	—	5	7	86.5	95.5	99.5	113.5	—	—	—	—	—	—
10	12.5	4.8	M8 x 1.0	48.5	56	68	80	—	—	—	—	5	7	88.5	96	108	120	—	—	—	—	—	—
16	12.5	4.8	M10 x 1.0	48.5	57	69	81	87	111	129	141	6	9	91.5	100	112	124	130	154	172	184	—	—

※: () in LS, S and Z dimensions: With auto switch

CJ2 Series

Single Acting, Spring Extend: Head Flange (G)

CJ2G6 – Stroke TZ

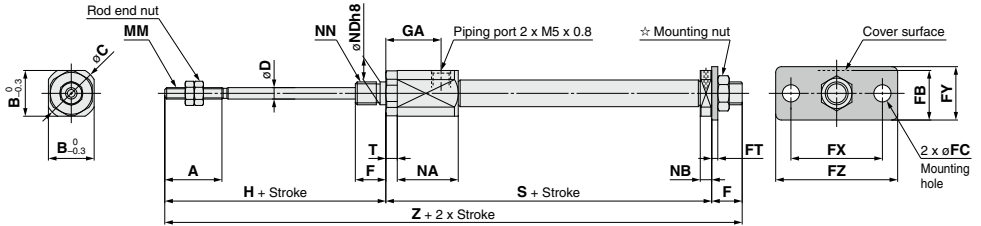

CJ2G ¹⁰/₁₆ – Stroke TZ

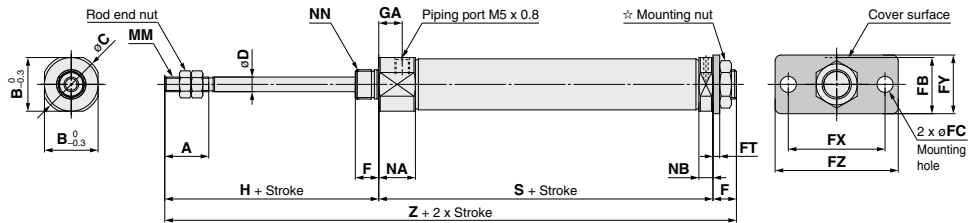

☆ For details of the mounting nut, refer to page 91.

Bore size	[mm]																
	A	B	C	D	F	FB	FC	FT	FX	FY	FZ	GA	H	MM	NA	NB	NN
6	15	12	14	3	8	13	4.5	1.6	24	14	32	14.5	28	M3 x 0.5	16	3	M6 x 1.0
10	15	12	14	4	8	13	4.5	1.6	24	14	32	8	28	M4 x 0.7	12.5	4.8	M8 x 1.0
16	15	18.3	20	5	8	19	5.5	2.3	33	20	42	8	28	M5 x 0.8	12.5	4.8	M10 x 1.0

Bore size	S										Z					
	5 to 15 st	16 to 30 st	31 to 45 st	46 to 60 st	61 to 75 st	76 to 100 st	101 to 125 st	126 to 150 st	5 to 15 st	16 to 30 st	31 to 45 st	46 to 60 st	61 to 75 st	76 to 100 st	101 to 125 st	126 to 150 st
6	46.5 (51.5)	55.5 (60.5)	59.5 (64.5)	73.5 (78.5)	—	—	—	—	82.5 (87.5)	91.5 (96.5)	95.5 (100.5)	109.5 (114.5)	—	—	—	—
10	48.5	56	68	80	—	—	—	—	84.5	92	104	116	—	—	—	—
16	48.5	57	69	81	87	111	129	141	84.5	93	105	117	123	147	165	177

※: () in S and Z dimensions: With auto switch

Single Acting, Spring Extend: Rod Flange (F)

CJ2F6 – Stroke TZ

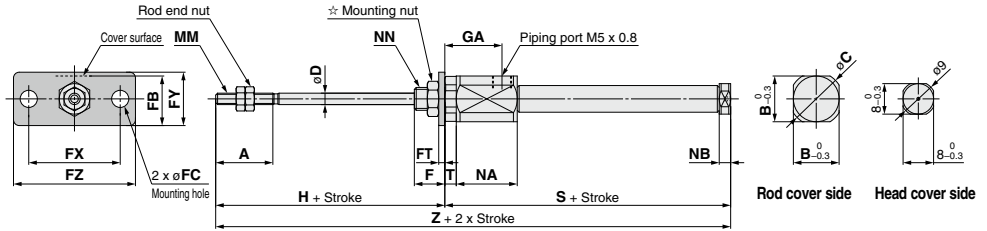

CJ2F 10/16 – Stroke TZ

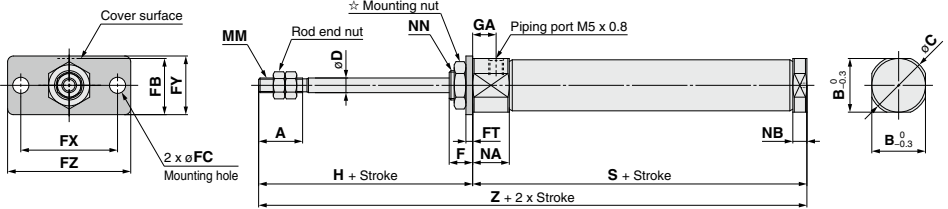

☆ For details of the mounting nut, refer to page 91.

Bore size	S													Z																				
	A	B	C	D	F	FB	FC	FT	FX	FY	FZ	GA	H	MM	NA	NB	NN	T	5 to 15 st	16 to 30 st	31 to 45 st	46 to 60 st	61 to 75 st	76 to 100 st	101 to 125 st	126 to 150 st	5 to 15 st	16 to 30 st	31 to 45 st	46 to 60 st	61 to 75 st	76 to 100 st	101 to 125 st	126 to 150 st
6	15	12	14	3	8	13	4.5	1.6	24	14	32	14.5	28	M3 x 0.5	16	3	M6 x 1.0	3	46.5 (51.5)	55.5 (60.5)	59.5 (64.5)	73.5 (78.5)	—	—	—	—	74.5 (79.5)	83.5 (88.5)	87.5 (92.5)	101.5 (106.5)	—	—	—	—
10	15	12	14	4	8	13	4.5	1.6	24	14	32	8	28	M4 x 0.7	12.5	4.8	M8 x 1.0	—	48.5 (51.5)	56 (59.5)	68 (71.5)	80 (83.5)	87	111	129	141	76.5 (79.5)	84 (87.5)	96 (99.5)	108 (111.5)	—	—	—	—
16	15	18.3	20	5	8	19	5.5	2.3	33	20	42	8	28	M5 x 0.8	12.5	4.8	M10 x 1.0	—	48.5 (51.5)	57 (60.5)	69 (72.5)	81 (84.5)	87	111	129	141	76.5 (79.5)	85 (88.5)	97 (100.5)	109 (112.5)	139	157	169	—

※: () in S and Z dimensions: With auto switch

Single Acting, Spring Extend: Double Clevis (D)

CJ2D 10/16 – Stroke TZ

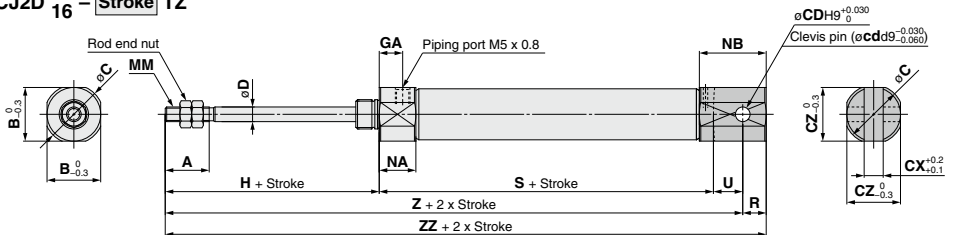

※: A clevis pin and retaining rings are included.

Bore size	S																					
	A	B	C	CD (cd)	CX	CZ	D	GA	H	MM	NA	NB	R	U	5 to 15 st	16 to 30 st	31 to 45 st	46 to 60 st	61 to 75 st	76 to 100 st	101 to 125 st	126 to 150 st
10	15	12	14	3.3	3.2	12	4	8	28	M4 x 0.7	12.5	17.8	5	8	48.5	56	68	80	—	—	—	—
16	15	18.3	20	5	6.5	18.3	5	8	28	M5 x 0.8	12.5	22.8	8	10	48.5	57	69	81	87	111	129	141

Bore size	Z													ZZ												
	5 to 15 st	16 to 30 st	31 to 45 st	46 to 60 st	61 to 75 st	76 to 100 st	101 to 125 st	126 to 150 st	5 to 15 st	16 to 30 st	31 to 45 st	46 to 60 st	61 to 75 st	76 to 100 st	101 to 125 st	126 to 150 st										
10	84.5	92	104	116	—	—	—	89.5	97	109	121	—	—	—	—											
16	86.5	95	107	119	125	149	167	179	94.5	103	115	127	133	157	175	187										

Air Cylinder: Non-rotating Rod Type Double Acting, Single Rod

CJ2K Series

ø10, ø16

RoHS



How to Order

With auto switch

CJ2K **B** 16 - 60 □ Z- □ □ - □

With auto switch (Built-in magnet)

CDJ2K **B** 16 - 60 □ Z- □ □ - **M9BW** □ - **B** - □

① ② ③ ④ ⑤ ⑥ ⑦ ⑧ ⑨ ⑩

1 Mounting

B	Basic
E	Double-side bossed
D**	Double clevis
L	Single foot
M	Double foot
F	Rod flange
G	Head flange

*: Foot/Flange brackets are shipped together with the product, but not assembled.

**: Refer to page 182 for the double clevis (with one-touch connecting pin).

2 Bore size

10	10 mm
16	16 mm

4 Head cover port location

Nil	Perpendicular to axis	
R	Axial	

*: For double clevis, the product is perpendicular to the cylinder axis.

*: For double-side bossed, the product is perpendicular to the cylinder axis.

3 Cylinder standard stroke [mm]

Refer to "Standard Strokes" on page 119.

5 Pivot bracket

Nil	None
N	Pivot bracket is shipped together with the product.

*: Only for the double clevis type
*: Pivot bracket is shipped together with the product, but not assembled.

6 Rod end bracket

Nil	None
V	Single knuckle joint
W**	Double knuckle joint
T	Rod end cap (Flat type)
U	Rod end cap (Round type)

*: Rod end bracket is shipped together with the product, but not assembled.
**: Refer to page 91 for the double knuckle joint (with one-touch connecting pin).

7 Auto switch

Nil	Without auto switch
------------	---------------------

*: For applicable auto switches, refer to the table below.

★ Enter the auto switch mounting type (A or B) even when a built-in magnet cylinder without an auto switch is required.

8 Number of auto switches

Nil	2 pcs.
S	1 pc.
n	"n" pcs.

9 Auto switch mounting type

A	Rail mounting
B	Band mounting

*: For rail mounting, screws and nuts for 2 auto switches come with the rail.

*: Refer to page 178 for auto switch mounting brackets.

10 Made to Order

Refer to page 119 for details.

*: Refer to "Ordering Example of Cylinder Assembly" on page 119.

Applicable Auto Switches/Refer to pages 1271 to 1365 for further information on auto switches.

Type	Special function	Electrical entry	Indicate light	Wiring (Output)	Load voltage		Auto switch model				Lead wire length [m]					Pre-wired connector	Applicable load								
					DC	AC	Band mounting		Rail mounting		0.5 (Nil)	1 (M)	3 (L)	5 (Z)	None (N)										
							Perpendicular	In-line	Perpendicular	In-line															
Solid state auto switch	—	Grommet	No	3-wire (NPN)	5 V, 12 V	—	M9NV	M9N	M9NV	M9N	●	●	●	○	—	○	C circuit	Relay, PLC							
				3-wire (PNP)			M9PV	M9P	M9PV	M9P	●	●	●	○	—	○									
		Connector	2-wire	M9BV			M9B	M9BV	M9B	●	●	●	○	—	○	—			○						
	Diagnostic indication (2-color indicator)	Grommet	Yes	3-wire (NPN)	5 V, 12 V	—	M9NV	M9NW	M9NV	M9NW	●	●	●	○	—	○			C circuit	Relay, PLC					
				3-wire (PNP)			M9PV	M9PW	M9PV	M9PW	●	●	●	○	—	○									
				Connector			2-wire	M9BV	M9B	M9BV	M9B	●	●	●	○	—					○	—	○		
Water resistant (2-color indicator)	Grommet	No	3-wire (NPN)	5 V, 12 V	—	M9NAV ^{*1}	M9NA ^{*1}	M9NAV ^{*1}	M9NA ^{*1}	○	○	○	○	—	○	C circuit	Relay, PLC								
			3-wire (PNP)			M9PAV ^{*1}	M9PA ^{*1}	M9PAV ^{*1}	M9PA ^{*1}	○	○	○	○	—	○										
			Connector			2-wire	M9BAV ^{*1}	M9BA ^{*1}	M9BAV ^{*1}	M9BA ^{*1}	○	○	●	○	—			○	—	○					
Reed auto switch	—	Grommet	No	3-wire (NPN equivalent)	5 V	—	A96V	A96	A96V	A96	●	—	●	—	—	—	C circuit	—							
				Connector			2-wire	24 V	12 V	—	—	—	A72	A72H	●	—			●	—	—	—			
										—	—	—	A93V ^{*2}	A93	A93V ^{*2}	A93			●	●	●	—	—	—	
										—	—	—	A90V	A90	A90V	A90			●	—	●	—	—	—	
				Diagnostic indication (2-color indicator)			Grommet	Yes	24 V	12 V	—	—	—	C73C	A73C	—			—	—	●	●	●	—	—
											—	—	—	C80C	A80C	—			—	—	—	—	—	—	—
—	—	—	A79W		A79W	—					—	—	—	—	—	—	—	—	—						

*1: Water resistant type auto switches can be mounted on the above models, but in such case SMC cannot guarantee water resistance. Please contact SMC regarding water resistant types with the above model numbers.

*2: 1 m type lead wire is only applicable to D-A93.

*: Lead wire length symbols: 0.5 m..... Nil (Example) M9NW
1 m..... M (Example) M9NWM
3 m..... L (Example) M9NWL
5 m..... Z (Example) M9NWZ
None..... N (Example) H7CN

*: Since there are other applicable auto switches than listed, refer to page 179 for details.

*: Solid state auto switches marked with "○" are produced upon receipt of order.

*: The D-A9□/M9□/A7□/A8□/F7□/J7□ auto switches are shipped together, but not assembled. (For band mounting, only auto switch mounting brackets are assembled before being shipped.)

A cylinder which rod does not rotate because of the hexagonal rod shape.

Non-rotating accuracy
 $\phi 10: \pm 1.5^\circ$, $\phi 16: \pm 1^\circ$
Can operate without lubrication.



Symbol

Double acting, Single rod, Rubber bumper

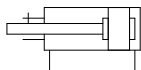

Made to Order: Individual Specifications
 (For details, refer to pages 180 to 182.)

Symbol	Specifications
-X446	PTFE grease
-X2838	Double clevis (With one-touch connecting pin)

Made to Order

[Click here for details](#)

Symbol	Specifications
-XA□	Change of rod end shape
-XC3	Special port location
-XC9	Adjustable stroke cylinder/Adjustable retraction type
-XC10	Dual stroke cylinder/Double rod type
-XC22	Fluororubber seal
-XC51	With hose nipple
-XC85	Grease for food processing equipment

⚠ Precautions

Refer to page 183 before handling.

Ordering Example of Cylinder Assembly

Cylinder model: **CDJ2KD16-60Z-NW-M9BW-B**

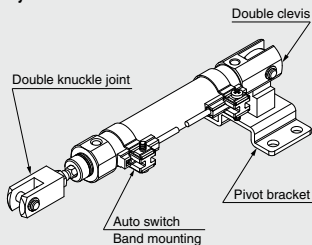

Mounting D: Double clevis
Pivot bracket N: Yes
Rod end bracket W: Double knuckle joint
Auto switch D-M9BW: 2 pcs.
Auto switch mounting B: Band mounting

*: Pivot bracket, double knuckle joint and auto switch are shipped together with the product, but not assembled.

Specifications

Bore size [mm]	10	16
Action	Double acting, Single rod	
Fluid	Air	
Proof pressure	1 MPa	
Maximum operating pressure	0.7 MPa	
Minimum operating pressure	0.06 MPa	
Ambient and fluid temperature	Without auto switch: -10°C to 70°C (No freezing) With auto switch: -10°C to 60°C	
Cushion	Rubber bumper	
Lubrication	Not required (Non-lube)	
Stroke length tolerance	± 1.0	
Rod non-rotating accuracy	$\pm 1.5^\circ$	$\pm 1^\circ$
Piston speed	50 to 750 mm/s	
Allowable kinetic energy	0.035 J	0.090 J

Standard Strokes

Bore size	Standard stroke [mm]
10	15, 30, 45, 60, 75, 100, 125, 150
16	15, 30, 45, 60, 75, 100, 125, 150, 175, 200

- *: Manufacture of intermediate strokes in 1 mm increments is possible. (Spacers are not used.)
- *: Please consult with SMC for strokes which exceed the standard stroke length.
- *: Applicable strokes should be confirmed according to the usage. For details, refer to "Air Cylinders Model Selection" on pages 8 to 19. In addition, the products that exceed the standard stroke might not be able to fulfill the specifications due to the deflection etc.

Mounting and Accessories / Refer to page 86 for the list of brackets and page 91 for details about part numbers and dimensions.

●: Mounted on the product. ○: Can be ordered within the cylinder model. △: Order separately.

Mounting		Basic	Foot	Flange	Double clevis	Double clevis (including T-bracket)
Standard	Mounting nut	●	●	●	—	—
	Rod end nut	●	●	●	●	●
	Clevis pin (including retaining rings)	—	—	—	●	●
Option	Double clevis (With one-touch connecting pin)	△	△	△	○ (-X2838)	○ (-X2838)
	Single knuckle joint	○	○	○	○	○
	Double knuckle joint (including a pin and retaining rings)	○	○	○	○	○
	Double knuckle joint (With one-touch connecting pin)	△	△	△	△	△
	Rod end cap (Flat/Round type)	○	○	○	○	○
Pivot bracket (T-bracket)	—	—	—	○	●	

Mounting Brackets/Part No.

Mounting bracket	Bore size [mm]	
	10	16
Foot	CJ-L016C	CJK-L016C
Flange	CJ-F016C	CJK-F016C
Pivot bracket (T-bracket)*1	CJ-T010C	CJ-T016C

*1: The pivot bracket (T-bracket) is used with double clevis (D).

Refer to pages 172 to 179 for cylinders with auto switches.

- Auto switch proper mounting position (detection at stroke end) and its mounting height
- Minimum stroke for auto switch mounting
- Operating range
- Auto switch mounting brackets/Part no.

CJ2K Series

Weights

		[g]	
Bore size [mm]		10	16
Basic weight (When the stroke is zero)	Basic	25	47
	Axial piping	25	47
	Double clevis (including clevis pin)	27	55
	Head-side bossed	29	50
Additional weight per 15 mm of stroke		4	7
Mounting bracket weight	Single foot	8	25
	Double foot	16	50
	Rod flange	5	13
	Head flange	5	13
Accessories	Clevis pin	1	3
	One-touch connecting pin for double clevis	2	4
	Single knuckle joint	17	23
	Double knuckle joint (including knuckle pin)	25	21
	Double knuckle joint (With one-touch connecting pin)	26	22
	Rod end cap (Flat type)	1	2
	Rod end cap (Round type)	1	2
	Pivot bracket (T-bracket)	32	50

*: Mounting nut and rod end nut are included in the basic weight.

*: Mounting nut is not included in the basic weight for the double clevis.

Calculation:

Example) **CJ2KL10-45Z**

- Basic weight25 (ø10)
 - Additional weight4/15 stroke
 - Cylinder stroke45 stroke
 - Mounting bracket weight ---8 (Single foot)
- $25 + 4/15 \times 45 + 8 = 45 \text{ g}$

Construction (Not able to disassemble)

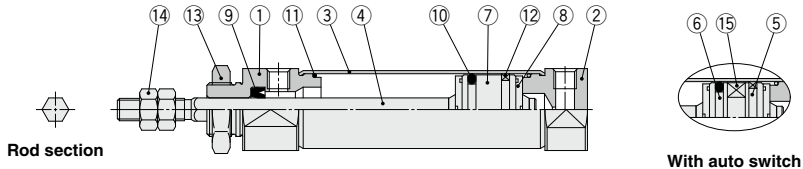

Component Parts

No.	Description	Material	Note
1	Rod cover	Aluminum alloy	
2	Head cover	Aluminum alloy	
3	Cylinder tube	Stainless steel	
4	Piston rod	Stainless steel	
5	Piston A	Aluminum alloy	
6	Piston B	Aluminum alloy	
7	Piston	Aluminum alloy	
8	Bumper	Urethane	

No.	Description	Material	Note
9	Rod seal	NBR	
10	Piston seal	NBR	
11	Tube gasket	NBR	
12	Wear ring	Resin	
13	Mounting nut	Rolled steel	
14	Rod end nut	Rolled steel	
15	Magnet	—	

Basic (B)

CJ2KB $\frac{10}{16}$ - Stroke Head cover port location Z

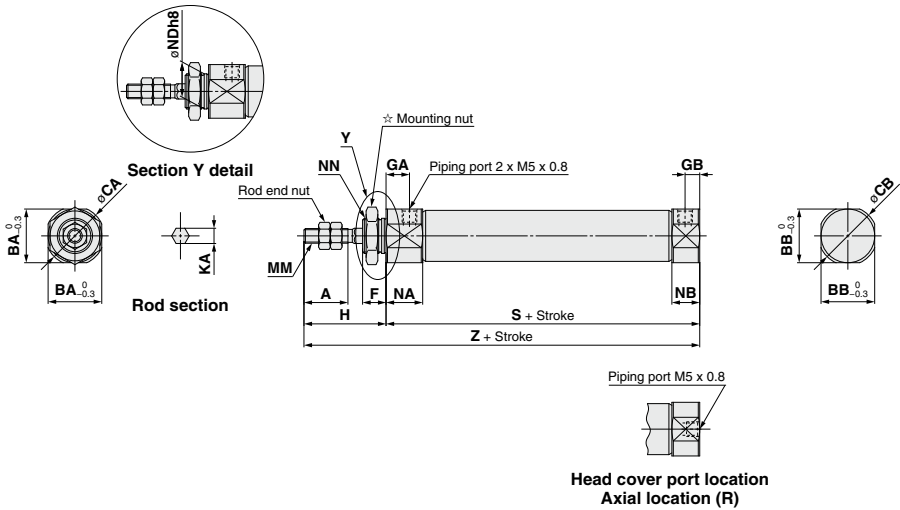

*: The overall cylinder length does not change.

* Refer to page 91 for details of the mounting nut. (SNJ-016C for $\phi 10$, SNKJ-016C for $\phi 16$)

Bore size	A	BA	BB	CA	CB	F	GA	GB	H	KA	MM	NA	NB	NDh8	NN	S	Z
10	15	15	12	17	14	8	8	5	28	4.2	M4 x 0.7	12.5	9.5	$10_{-0.022}^0$	M10 x 1.0	46	74
16	15	18.3	18.3	20	20	8	8	5	28	5.2	M5 x 0.8	12.5	9.5	$12_{-0.027}^0$	M12 x 1.0	47	75

Double-side Bossed (E)

CJ2KE $\frac{10}{16}$ - Stroke Z

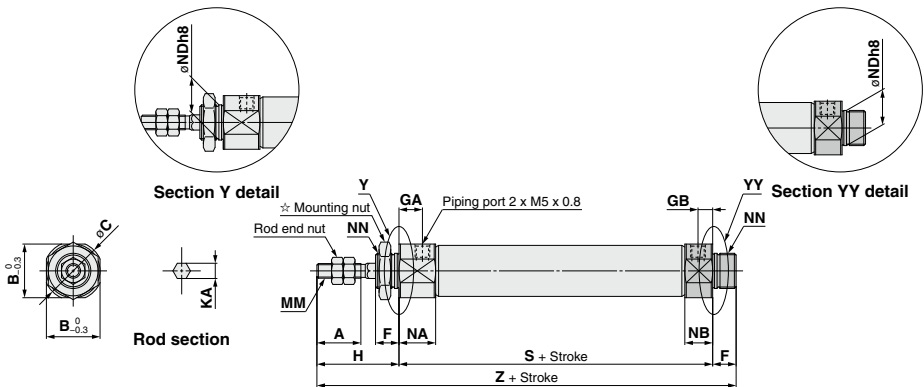

* Refer to page 91 for details of the mounting nut. (SNJ-016C for $\phi 10$, SNKJ-016C for $\phi 16$)

Bore size	A	B	C	F	GA	GB	H	KA	MM	NA	NB	NDh8	NN	S	Z
10	15	15	17	8	8	5	28	4.2	M4 x 0.7	12.5	9.5	$10_{-0.022}^0$	M10 x 1.0	46	82
16	15	18.3	20	8	8	5	28	5.2	M5 x 0.8	12.5	9.5	$12_{-0.027}^0$	M12 x 1.0	47	83

CJ2K Series

Double Clevis (D)

CJ2KD $\frac{10}{16}$ - Stroke Z

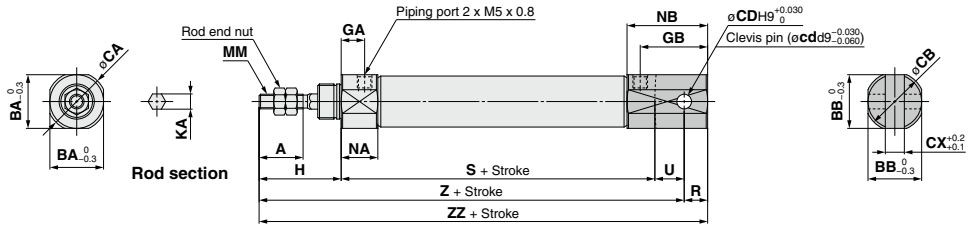

※: A clevis pin and retaining rings are included.

Bore size	A	BA	BB	CA	CB	CD(cd)	CX	GA	GB	H	KA	MM	NA	NB	R	S	U	Z	ZZ
10	15	15	12	17	14	3.3	3.2	8	18	28	4.2	M4 x 0.7	12.5	22.5	5	46	8	82	87
16	15	18.3	18.3	20	20	5	6.5	8	23	28	5.2	M5 x 0.8	12.5	27.5	8	47	10	85	93

Single Foot (L)

CJ2KL $\frac{10}{16}$ - Stroke Head cover port location Z

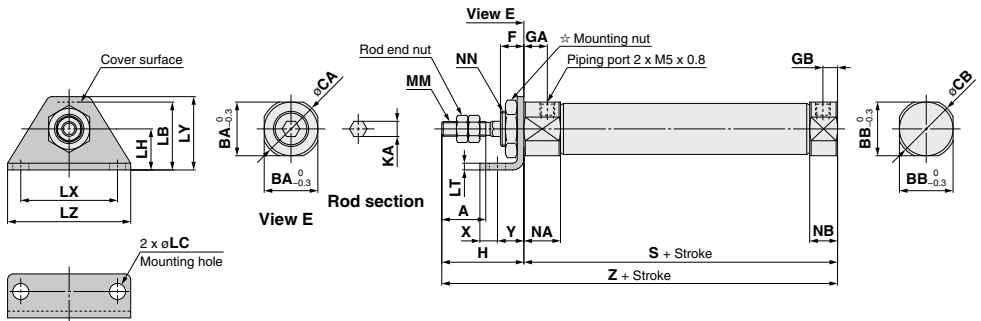

Head cover port location Axial location (R)

※: The overall cylinder length does not change.

☆ Refer to page 91 for details of the mounting nut. (SNJ-016C for ø10, SNKJ-016C for ø16)

Bore size	A	BA	BB	CA	CB	F	GA	GB	H	KA	LB	LC	LH	LT	LX	LY	LZ	MM	NA	NB	NN	S	X	Y	Z
10	15	15	12	17	14	8	8	5	28	4.2	21.5	5.5	14	2.3	33	25	42	M4 x 0.7	12.5	9.5	M10 x 1.0	46	6	9	74
16	15	18.3	18.3	20	20	8	8	5	28	5.2	23	5.5	14	2.3	33	25	42	M5 x 0.8	12.5	9.5	M12 x 1.0	47	6	9	75

Double Foot (M)

CJ2KM $\frac{10}{16}$ - Stroke Z

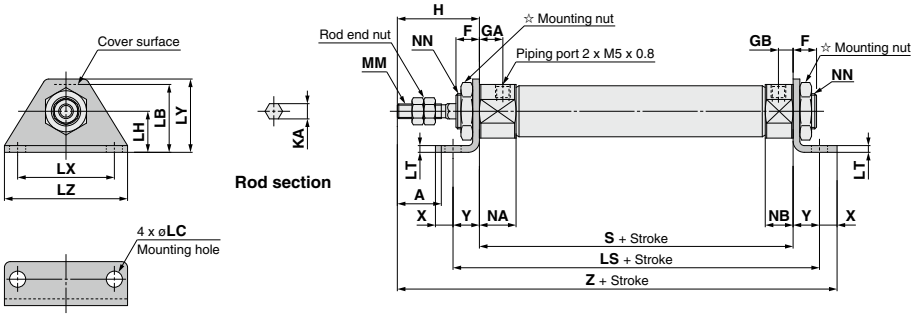

☆ Refer to page 91 for details of the mounting nut. (SNJ-016C for ø10, SNKJ-016C for ø16)

Bore size	A	F	GA	GB	H	KA	LB	LC	LH	LS	LT	LX	LY	LZ	MM	NA	NB	NN	S	X	Y	Z
10	15	8	8	5	28	4.2	21.5	5.5	14	64	2.3	33	25	42	M4 x 0.7	12.5	9.5	M10 x 1.0	46	6	9	89
16	15	8	8	5	28	5.2	23	5.5	14	65	2.3	33	25	42	M5 x 0.8	12.5	9.5	M12 x 1.0	47	6	9	90

Rod Flange (F)

CJ2KF $\frac{10}{16}$ - Stroke Head cover port location Z

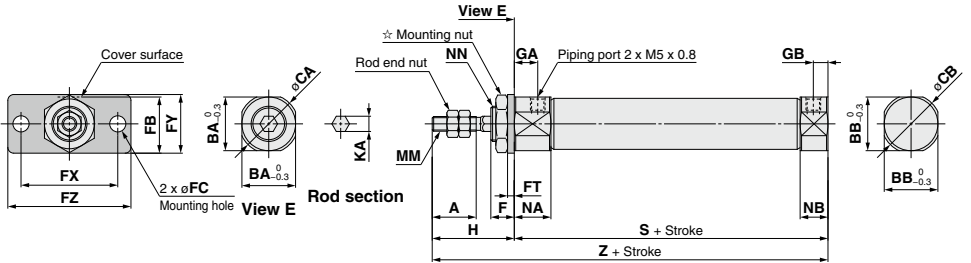

Piping port M5 x 0.8



Head cover port location Axial location (R)

※ The overall cylinder length does not change.

☆ Refer to page 91 for details of the mounting nut. (SNJ-016C for ø10, SNKJ-016C for ø16)

Bore size	A	BA	BB	CA	CB	F	FB	FC	FT	FX	FY	FZ	GA	GB	H	KA	MM	NA	NB	NN	S	Z
10	15	15	12	17	14	8	17.5	5.5	2.3	33	20	42	8	5	28	4.2	M4 x 0.7	12.5	9.5	M10 x 1.0	46	74
16	15	18.3	18.3	20	20	8	19	5.5	2.3	33	20	42	8	5	28	5.2	M5 x 0.8	12.5	9.5	M12 x 1.0	47	75

CJ2K Series

Head Flange (G)

CJ2KG $\frac{10}{16}$ - Stroke Z

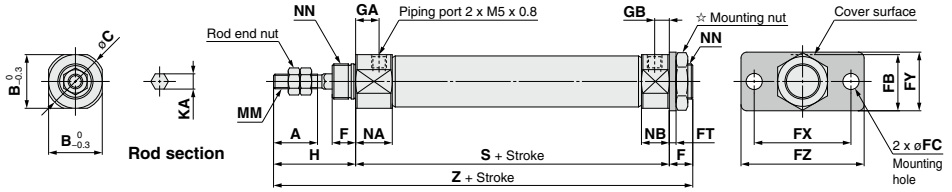

☆ Refer to page 91 for details of the mounting nut. (SNJ-016C for $\phi 10$, SNKJ-016C for $\phi 16$)

Bore size	A	B	C	F	FB	FC	FT	FX	FY	FZ	GA	GB	H	KA	MM	NA	NB	NN	S	Z
10	15	15	17	8	17.5	5.5	2.3	33	20	42	8	5	28	4.2	M4 x 0.7	12.5	9.5	M10 x 1.0	46	82
16	15	18.3	20	8	19	5.5	2.3	33	20	42	8	5	28	5.2	M5 x 0.8	12.5	9.5	M12 x 1.0	47	83

Air Cylinder: Non-rotating Rod Type Single Acting, Spring Return/Extend

CJ2K Series

ø10, ø16

RoHS

How to Order

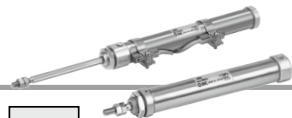

CJ2K **B** 16 - 45 **S** □ **Z** - □ - □ - □

With auto switch

CDJ2K **B** 16 - 45 **S** □ **Z** - □ - □ - □ - **M9BW** □ - **B** - □

With auto switch (Built-in magnet)

① ② ③ ④ ⑤ ⑥ ⑦ ⑧ ⑨ ⑩ ⑪

① Mounting

B	Basic
E	Double-side bossed
D**	Double clevis
L	Single foot
M	Double foot
F	Rod flange
G	Head flange

*: Foot/Flange brackets are shipped together with the product, but not assembled.

**: Refer to page 182 for the double clevis (with one-touch connecting pin).

③ Auto switch

Nil	Without auto switch
------------	---------------------

*: For applicable auto switches, refer to the table below.

* Enter the auto switch mounting type (A or B) even when a built-in magnet cylinder without an auto switch is required.

② Bore size

10	10 mm
16	16 mm

⑤ Head cover port location

Nil	Perpendicular to axis	
R	Axial	

*: For double clevis, the product is perpendicular to the cylinder axis.
*: For double-side bossed, the product is perpendicular to the cylinder axis.
*: Not applicable to single acting, spring extend (T).

⑨ Number of auto switches

Nil	2 pcs.
S	1 pc.
n	"n" pcs.

③ Cylinder standard stroke [mm]

Refer to "Standard Strokes" on page 126.

⑥ Pivot bracket

Nil	None
N	Pivot bracket is shipped together with the product.

*: Only for the double clevis type
*: Pivot bracket is shipped together with the product, but not assembled.

④ Action

S	Single acting, Spring return
T	Single acting, Spring extend

⑦ Rod end bracket

Nil	None
V	Single knuckle joint
W**	Double knuckle joint
T	Rod end cap (Flat type)
U	Rod end cap (Round type)

*: Rod end bracket is shipped together with the product, but not assembled.
**: Refer to page 91 for the double knuckle joint (with one-touch connecting pin).

⑩ Auto switch mounting type

A	Rail mounting
B	Band mounting

*: For rail mounting, screws and nuts for 2 auto switches come with the rail.
*: Refer to page 178 for auto switch mounting brackets.

⑪ Made to Order

Refer to page 119 for details.

*: Refer to "Ordering Example of Cylinder Assembly" on page 126.

Applicable Auto Switches/Refer to pages 1271 to 1365 for further information on auto switches.

Type	Special function	Electrical entry	Indicating light	Wiring (Output)	Load voltage		Auto switch model				Lead wire length [m]					Pre-wired connector	Applicable load					
					DC	AC	Band mounting		Rail mounting		0.5 (Nil)	1 (M)	3 (L)	5 (Z)	None (N)							
							Perpendicular	In-line	Perpendicular	In-line												
Solid state auto switch	—	Grommet	No	3-wire (NPN) 3-wire (PNP)	5 V, 12 V	—	M9NV	M9N	M9NV	M9N	●	●	●	○	○	IC circuit	—					
							M9PV	M9P	M9PV	M9P	●	●	●	○	○							
							M9BV	M9B	M9BV	M9B	●	●	●	○	○							
	Diagnostic indication (2-color indicator)	Connector	Yes	3-wire (NPN) 2-wire	24 V	—	M9NV	M9NW	M9NV	M9NW	●	●	●	○	○	IC circuit	Relay, PLC					
							M9PV	M9PW	M9PV	M9PW	●	●	●	○	○							
							M9BV	M9BW	M9BV	M9BW	●	●	●	○	○							
	Water resistant (2-color indicator)	Grommet	No	3-wire (NPN) 3-wire (PNP) 2-wire	5 V, 12 V	—	M9NAV ^{*1}	M9NA ^{*1}	M9NAV ^{*1}	M9NA ^{*1}	○	○	●	○	○	IC circuit	—					
							M9PAV ^{*1}	M9PA ^{*1}	M9PAV ^{*1}	M9PA ^{*1}	○	○	●	○	○							
							M9BAV ^{*1}	M9BA ^{*1}	M9BAV ^{*1}	M9BA ^{*1}	○	○	●	○	○							
With diagnostic output (2-color indicator)	Grommet	Yes	4-wire (NPN)	5 V, 12 V	—	—	H7NF	—	F79F	●	—	●	○	○	IC circuit	—						
						Reed auto switch	Grommet	No	3-wire (NPN equivalent)	—	A96V	A96	A96V	A96			●	●	—	—	IC circuit	—
											—	—	A72	A72H			●	—	—	—		
—	—	A93V ^{*2}	A93	A93V ^{*2}	A93						●	●	●	—	—							
Diagnostic indication (2-color indicator)	Connector	No	2-wire	24 V	12 V	100 V or less	A90V	A90	A90V	A90	●	—	—	—	IC circuit	Relay, PLC						
						—	C73C	A73C	—	●	—	●	●	—			—					
						24 V or less	C80C	A80C	—	●	—	●	●	—			—					
—	Grommet	Yes	—	—	—	—	A79W	—	—	●	—	●	—	IC circuit	—							

*1: Water resistant type auto switches can be mounted on the above models, but in such case SMC cannot guarantee water resistance.

*2: 1 m type lead wire is only applicable to D-A93.

*: Lead wire length symbols: 0.5 m..... Nil (Example) M9NV
1 m..... M (Example) M9NWM
3 m..... L (Example) M9NWL

5 m..... Z (Example) M9NWX
None..... N (Example) H7CN

*: Since there are other applicable auto switches than listed, refer to page 179 for details.

*: Solid state auto switches marked with "○" are produced upon receipt of order.

*: The D-A9J/M9C/A7C/A80C/F7J/J7C auto switches are shipped together, but not assembled. (For band mounting, only auto switch mounting brackets are assembled before being shipped.)

CJ2K Series

A cylinder which rod does not rotate because of the hexagonal rod shape.

Non-rotating accuracy

∅10: ±1.5°, ∅16: ±1°

Can operate without lubrication.



Spring return

Symbol

Single acting, Spring return, Rubber bumper

Single acting, Spring extend, Rubber bumper

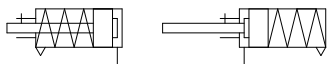

Made to Order: Individual Specifications
(For details, refer to pages 180 to 182.)

Symbol	Specifications
-X446	PTFE grease
-X2838	Double clevis (With one-touch connecting pin)

Made to Order

[Click here for details](#)

Symbol	Specifications
-XA□	Change of rod end shape
-XC51	With hose nipple
-XC85	Grease for food processing equipment



Precautions

Refer to page 183 before handling.

Ordering Example of Cylinder Assembly

Cylinder model: CDJ2KD16-45SZ-NW-M9BW-B

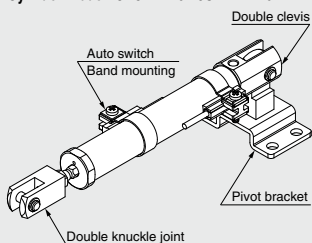

Mounting D: Double clevis
Pivot bracket N: Yes
Rod end bracket W: Double knuckle joint
Auto switch D-M9BW: 2 pcs.
Auto switch mounting B: Band mounting

*: Pivot bracket, double knuckle joint and auto switch are shipped together with the product, but not assembled.

Specifications

Bore size [mm]	10	16
Action	Single acting, Spring return/Single acting, Spring extend	
Fluid	Air	
Proof pressure	1 MPa	
Maximum operating pressure	0.7 MPa	
Minimum operating pressure	0.15 MPa	
Ambient and fluid temperature	Without auto switch: -10°C to 70°C (No freezing) With auto switch: -10°C to 60°C	
Cushion	Rubber bumper (standard equipment)	
Lubrication	Not required (Non-lube)	
Stroke length tolerance	+1.0	
Rod non-rotating accuracy	±1.5°	±1°
Piston speed	50 to 750 mm/s	
Allowable kinetic energy	0.035 J	0.090 J

Standard Strokes

Bore size	Standard stroke [mm]
10	15, 30, 45, 60
16	15, 30, 45, 60, 75, 100, 125, 150

- *: Manufacture of intermediate strokes in 1 mm increments is possible. (Spacers are not used.)
- *: Please consult with SMC for strokes which exceed the standard stroke length.
- *: Applicable strokes should be confirmed according to the usage. For details, refer to "Air Cylinders Model Selection" on pages 8 to 19. In addition, the products that exceed the standard stroke might not be able to fulfill the specifications due to the deflection etc.

Spring Reaction Force

Refer to page 1571 (Table (2): Spring Reaction Force).

Mounting and Accessories

●...Mounted on the product. ○...Can be ordered within the cylinder model. △...Order separately.

	Mounting	Basic	Foot	Flange	Double clevis	Double clevis (including T-bracket)
Standard	Mounting nut	●	●	●	—	—
	Rod end nut	●	●	●	●	●
	Clevis pin (including retaining rings)	—	—	—	●	●
Option	Double clevis (With one-touch connecting pin)	△	△	△	○ (-X2838)	○ (-X2838)
	Single knuckle joint	○	○	○	○	○
	Double knuckle joint (including a pin and retaining rings)	○	○	○	○	○
	Double knuckle joint (With one-touch connecting pin)	△	△	△	△	△
	Rod end cap (Flat/Round type)	○	○	○	○	○
	Pivot bracket (T-bracket)	—	—	—	○	●

Mounting Brackets/Part No.

Mounting bracket	Bore size [mm]	
	10	16
Foot	CJ-L016C	CJK-L016C
Flange	CJ-F016C	CJK-F016C
Pivot bracket (T-bracket)*1	CJ-T010C	CJ-T016C

*1: The pivot bracket (T-bracket) is used with double clevis (D).

Refer to pages 172 to 179 for cylinders with auto switches.

- Auto switch proper mounting position (detection at stroke end) and its mounting height
- Minimum stroke for auto switch mounting
- Operating range
- Auto switch mounting brackets/Part no.

Weights

Spring Return

[g]

Bore size [mm]		10				16			
		Basic	Axial piping	Double clevis (including clevis pin)	Double-side bossed	Basic	Axial piping	Double clevis (including clevis pin)	Double-side bossed
Basic weight	15 stroke	30	30	30	31	64	64	70	66
	30 stroke	38	38	38	39	79	79	86	81
	45 stroke	48	48	48	49	97	97	104	99
	60 stroke	58	58	58	59	116	116	122	118
	75 stroke	/				138	138	144	140
	100 stroke					171	171	178	173
	125 stroke					209	209	215	211
	150 stroke					232	232	238	234
150 stroke	232					232	238	234	
Mounting bracket weight	Single foot	8				25			
	Double foot	16				50			
	Rod flange	5				13			
	Head flange	5				13			
Accessories	Clevis pin	—	—	1	—	—	—	3	—
	One-touch connecting pin for double clevis	—	—	2	—	—	—	4	—
	Single knuckle joint	17				23			
	Double knuckle joint (including knuckle pin)	25				21			
	Double knuckle joint (With one-touch connecting pin)	26				22			
	Rod end cap (Flat type)	1				2			
	Rod end cap (Round type)	1				2			
Pivot Bracket (T-bracket)	32				50				

*: Mounting nut and rod end nut are included in the basic weight.

*: Mounting nut is not included in the basic weight for the double clevis.

Calculation:

Example) **CJ2KL10-45SZ**

- Basic weight 48 (ø10)
- Cylinder stroke 45 stroke
- Mounting bracket weight 8 (Single foot)

$$48 + 8 = 56 \text{ g}$$

Spring Extend

[g]

Bore size [mm]		10				16			
		Basic	Axial piping	Double clevis (including clevis pin)	Double-side bossed	Basic	Axial piping	Double clevis (including clevis pin)	Double-side bossed
Basic weight	15 stroke	29	29	31	31	64	64	72	69
	30 stroke	35	35	37	38	79	79	86	83
	45 stroke	44	44	46	46	95	95	103	99
	60 stroke	52	52	54	55	111	111	119	115
	75 stroke	/				133	133	140	137
	100 stroke					163	163	170	167
	125 stroke					198	198	206	202
	150 stroke					219	219	227	223
150 stroke	219					219	227	223	
Mounting bracket weight	Single foot	8				25			
	Double foot	16				50			
	Rod flange	5				13			
	Head flange	5				13			
Accessories	Clevis pin	—	—	1	—	—	—	3	—
	One-touch connecting pin for double clevis	—	—	2	—	—	—	4	—
	Single knuckle joint	17				23			
	Double knuckle joint (including knuckle pin)	25				21			
	Double knuckle joint (With one-touch connecting pin)	26				22			
	Rod end cap (Flat type)	1				2			
	Rod end cap (Round type)	1				2			
Pivot Bracket (T-bracket)	32				50				

*: Mounting nut and rod end nut are included in the basic weight.

*: Mounting nut is not included in the basic weight for the double clevis.

Calculation:

Example) **CJ2KL10-45TZ**

- Basic weight 44 (ø10)
- Cylinder stroke 45 stroke
- Mounting bracket weight 8 (Single foot)

$$44 + 8 = 52 \text{ g}$$

CJ2K Series

Construction (Not able to disassemble)

Single acting, Spring return

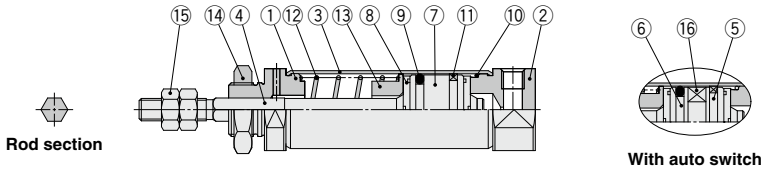

Single acting, Spring extend

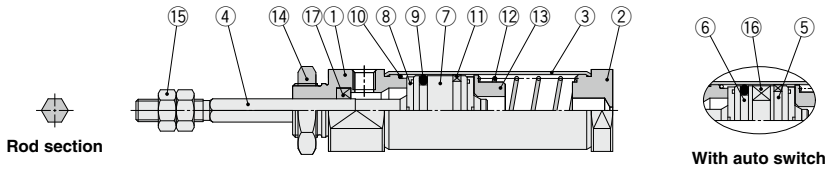

Component Parts

No.	Description	Material	Note
1	Rod cover	Aluminum alloy	
2	Head cover	Aluminum alloy	
3	Cylinder tube	Stainless steel	
4	Piston rod	Stainless steel	
5	Piston A	Aluminum alloy	
6	Piston B	Aluminum alloy	
7	Piston	Aluminum alloy	
8	Bumper	Urethane	
9	Piston seal	NBR	

No.	Description	Material	Note
10	Tube gasket	NBR	
11	Wear ring	Resin	
12	Return spring	Piano wire	
13	Spring seat	Aluminum alloy	
14	Mounting nut	Rolled steel	
15	Rod end nut	Rolled steel	
16	Magnet	—	
17	Rod seal	NBR	

Single Acting, Spring Return: Basic (B)

CJ2KB $\frac{10}{16}$ - Stroke S Head cover port location Z

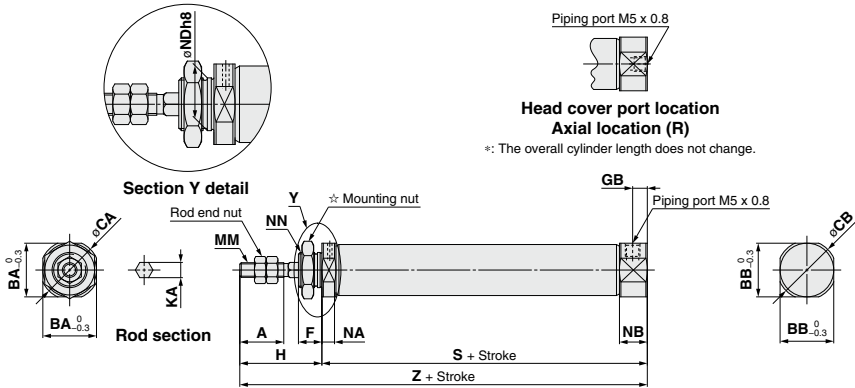

☆ For details of the mounting nut, refer to page 91.

[mm]

Bore size	A	BA	BB	CA	CB	F	GB	H	KA	MM	NA	NB	NDh8	NN	S								Z							
															5 to 15 st	16 to 30 st	31 to 45 st	46 to 60 st	61 to 75 st	76 to 100 st	101 to 125 st	126 to 150 st	5 to 15 st	16 to 30 st	31 to 45 st	46 to 60 st	61 to 75 st	76 to 100 st	101 to 125 st	126 to 150 st
10	15	15	12	17	14	8	5	28	4.2	M4 x 0.7	4.8	9.5	10 _{0.022}	M10 x 1.0	45.5	53	65	77	—	—	—	—	73.5	81	93	105	—	—	—	—
16	15	18.3	18.3	20	20	8	5	28	5.2	M5 x 0.8	4.8	9.5	12 _{0.027}	M12 x 1.0	45.5	54	66	78	84	108	126	138	73.5	82	94	106	112	136	154	166

Single Acting, Spring Return: Double-side Bossed (E)

CJ2KE $\frac{10}{16}$ - Stroke SZ

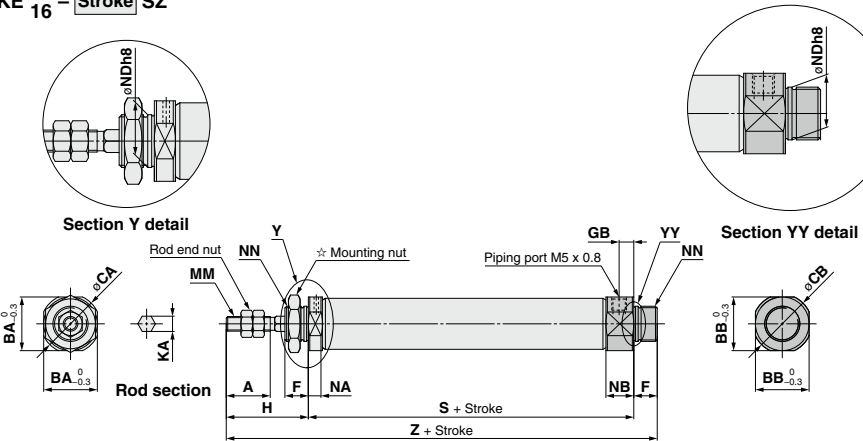

☆ For details of the mounting nut, refer to page 91.

[mm]

Bore size	A	BA	BB	CA	CB	F	GB	H	KA	MM	NA	NB	NDh8	NN	S								Z							
															5 to 15 st	16 to 30 st	31 to 45 st	46 to 60 st	61 to 75 st	76 to 100 st	101 to 125 st	126 to 150 st	5 to 15 st	16 to 30 st	31 to 45 st	46 to 60 st	61 to 75 st	76 to 100 st	101 to 125 st	126 to 150 st
10	15	15	15	17	17	8	5	28	4.2	M4 x 0.7	4.8	9.5	10 _{0.022}	M10 x 1.0	45.5	53	65	77	—	—	—	—	81.5	89	101	113	—	—	—	—
16	15	18.3	18.3	20	20	8	5	28	5.2	M5 x 0.8	4.8	9.5	12 _{0.027}	M12 x 1.0	45.5	54	66	78	84	108	126	138	81.5	90	102	114	120	144	162	174

CJ2K Series

Single Acting, Spring Return: Double Clevis (D)

CJ2KD $\frac{10}{16}$ - Stroke SZ

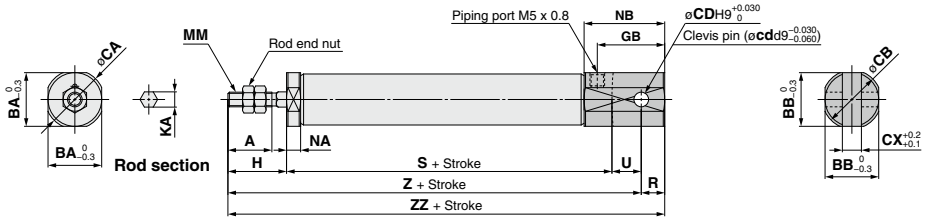

※: A clevis pin and retaining rings are included.

Bore size	A	BA	BB	CA	CB	CD (cd)	CX	GB	H	KA	MM	NA	NB	R	U	S							
																5 to 15 st	16 to 30 st	31 to 45 st	46 to 60 st	61 to 75 st	76 to 100 st	101 to 125 st	126 to 150 st
10	15	12	12	14	14	3.3	3.2	18	20	4.2	M4 x 0.7	4.8	22.5	5	8	45.5	53	65	77	—	—	—	—
16	15	18.3	18.3	20	20	5	6.5	23	20	5.2	M5 x 0.8	4.8	27.5	8	10	45.5	54	66	78	84	108	126	138

Bore size	Z								ZZ							
	5 to 15 st	16 to 30 st	31 to 45 st	46 to 60 st	61 to 75 st	76 to 100 st	101 to 125 st	126 to 150 st	5 to 15 st	16 to 30 st	31 to 45 st	46 to 60 st	61 to 75 st	76 to 100 st	101 to 125 st	126 to 150 st
10	73.5	81	93	105	—	—	—	—	78.5	86	98	110	—	—	—	—
16	75.5	84	96	108	114	138	156	168	83.5	92	104	116	122	146	164	176

Single Acting, Spring Return: Single Foot (L)

CJ2KL $\frac{10}{16}$ - Stroke S Head cover port location Z

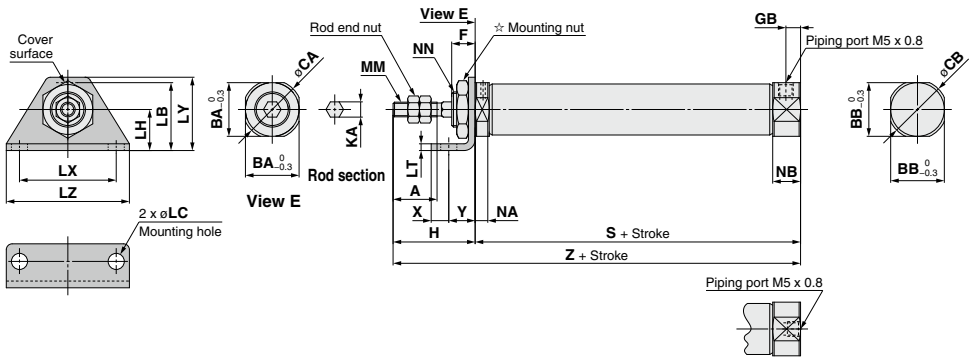

Head cover port location
Axial location (R)

※: The overall cylinder length does not change.

☆ For details of the mounting nut, refer to page 91.

Bore size	A	BA	BB	CA	CB	F	GB	H	KA	LB	LC	LH	LT	LX	LY	LZ	MM	NA	NB	NN
16	15	18.3	18.3	20	20	8	5	28	5.2	23	5.5	14	2.3	33	25	42	M5 x 0.8	4.8	9.5	M12 x 1.0

Bore size	S								X	Y	Z									
	5 to 15 st	16 to 30 st	31 to 45 st	46 to 60 st	61 to 75 st	76 to 100 st	101 to 125 st	126 to 150 st			5 to 15 st	16 to 30 st	31 to 45 st	46 to 60 st	61 to 75 st	76 to 100 st	101 to 125 st	126 to 150 st		
10	45.5	53	65	77	—	—	—	—	6	9	73.5	81	93	105	—	—	—	—	—	—
16	45.5	54	66	78	84	108	126	138	6	9	73.5	82	94	106	112	136	154	166	—	—

Single Acting, Spring Return: Double Foot (M)

CJ2KM $\frac{10}{16}$ - Stroke SZ

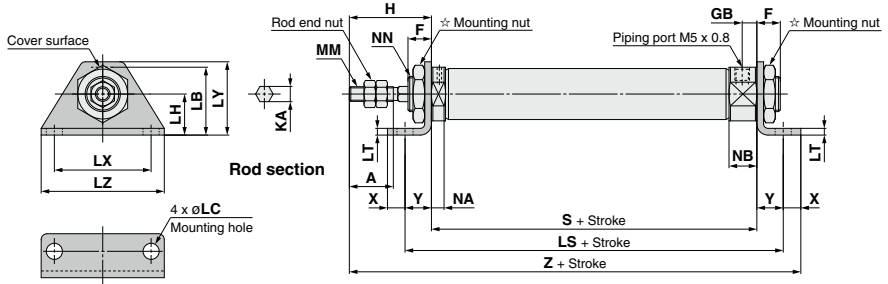

☆ For details of the mounting nut, refer to page 91.

Bore size	A	F	GB	H	LB	LC	LH	LS								KA	MM	NA	NB	NN				
								5 to 15 st	16 to 30 st	31 to 45 st	46 to 60 st	61 to 75 st	76 to 100 st	101 to 125 st	126 to 150 st						LT	LX	LY	LZ
10	15	8	5	28	21.5	5.5	14	63.5	71	83	95	—	—	—	2.3	33	25	42	4.2	M4 x 0.7	4.8	9.5	M10 x 1.0	
16	15	8	5	28	23	5.5	14	63.5	72	84	96	102	126	144	156	2.3	33	25	42	5.2	M5 x 0.8	4.8	9.5	M12 x 1.0

Bore size	S									X	Y	Z												
	5 to 15 st	16 to 30 st	31 to 45 st	46 to 60 st	61 to 75 st	76 to 100 st	101 to 125 st	126 to 150 st	5 to 15 st			16 to 30 st	31 to 45 st	46 to 60 st	61 to 75 st	76 to 100 st	101 to 125 st	126 to 150 st						
10	45.5	53	65	77	—	—	—	—	—	6	9	88.5	96	108	120	—	—	—	—	—	—	—	—	—
16	45.5	54	66	78	84	108	126	138	138	6	9	88.5	97	109	121	127	151	169	181	—	—	—	—	—

Single Acting, Spring Return: Rod Flange (F)

CJ2KF $\frac{10}{16}$ - Stroke S Head cover port location Z

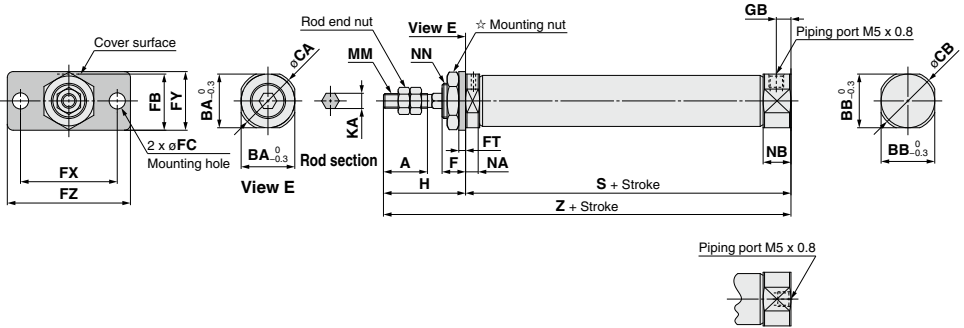

☆ For details of the mounting nut, refer to page 91.

*: The overall cylinder length does not change.

Bore size	A	BA	BB	CA	CB	F	FB	FC	FY	FZ	GH	KA	MM	NA	NB	NN	S								Z															
																	5 to 15 st	16 to 30 st	31 to 45 st	46 to 60 st	61 to 75 st	76 to 100 st	101 to 125 st	126 to 150 st	5 to 15 st	16 to 30 st	31 to 45 st	46 to 60 st	61 to 75 st	76 to 100 st	101 to 125 st	126 to 150 st								
10	15	15	12	17	14	8	17.5	5.5	2.3	33	20	42	5	28	4.2	M4 x 0.7	4.8	9.5	M10 x 1.0	45.5	53	65	77	—	—	—	—	—	—	—	—	—	—	—	—	—	—	—	—	—
16	15	18.3	18.3	20	20	8	19	5.5	2.3	33	20	42	5	28	5.2	M5 x 0.8	4.8	9.5	M12 x 1.0	45.5	54	66	78	84	108	126	138	138	138	73.5	82	94	106	112	136	154	166			

CJ2K Series

Single Acting, Spring Return: Head Flange (G)

CJ2KG $\frac{10}{16}$ - Stroke SZ

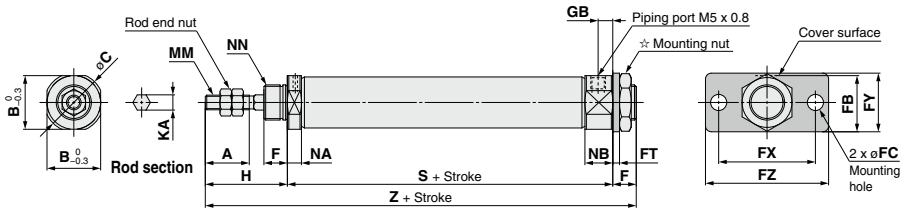

☆ For details of the mounting nut, refer to page 91.

[mm]

Bore size	A	B	C	F	FB	FC	FT	FX	FY	FZ	GB	H	KA	MM	NA	NB	NN
10	15	15	17	8	17.5	5.5	2.3	33	20	42	5	28	4.2	M4 x 0.7	4.8	9.5	M10 x 1.0
16	15	18.3	20	8	19	5.5	2.3	33	20	42	5	28	5.2	M5 x 0.8	4.8	9.5	M12 x 1.0

Bore size	S								Z							
	5 to 15 st	16 to 30 st	31 to 45 st	46 to 60 st	61 to 75 st	76 to 100 st	101 to 125 st	126 to 150 st	5 to 15 st	16 to 30 st	31 to 45 st	46 to 60 st	61 to 75 st	76 to 100 st	101 to 125 st	126 to 150 st
10	45.5	53	65	77	—	—	—	—	81.5	89	101	113	—	—	—	—
16	45.5	54	66	78	84	108	126	138	81.5	90	102	114	120	144	162	174

Single Acting, Spring Extend: Basic (B)

CJ2KB $\frac{10}{16}$ - Stroke TZ

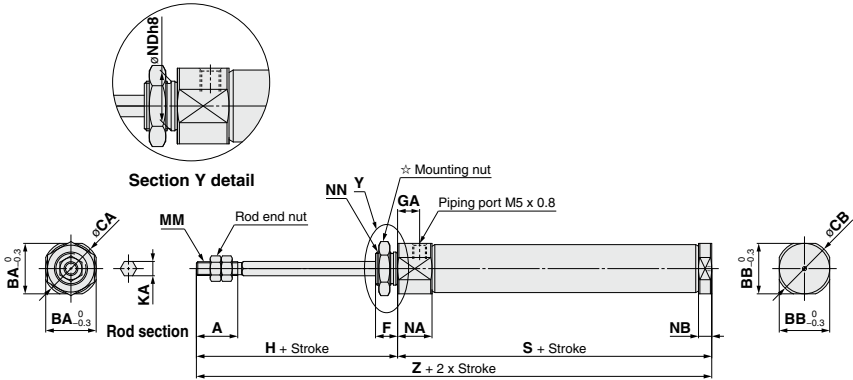

☆ For details of the mounting nut, refer to page 91.

Bore size	A	BA	BB	CA	CB	F	GA	H	KA	MM	NA	NB	NDh8	NN	S										Z											
															5 to 15 st	16 to 30 st	31 to 45 st	46 to 60 st	61 to 75 st	76 to 100 st	101 to 125 st	126 to 150 st	5 to 15 st	16 to 30 st	31 to 45 st	46 to 60 st	61 to 75 st	76 to 100 st	101 to 125 st	126 to 150 st						
10	15	15	12	17	14	8	8	28	4.2	M4 x 0.7	12.5	4.8	10 $_{-0.022}^0$	M10 x 1.0	48.5	56	68	80	—	—	—	—	—	—	—	—	—	—	—	—	—	—	—	—	—	
16	15	18.3	18.3	20	20	8	8	28	5.2	M5 x 0.8	12.5	4.8	12 $_{-0.022}^0$	M12 x 1.0	48.5	57	69	81	87	111	129	141	141	141	141	76.5	85	97	109	115	139	157	169	—	—	—

Single Acting, Spring Extend: Double-side Bossed (E)

CJ2KE $\frac{10}{16}$ - Stroke TZ

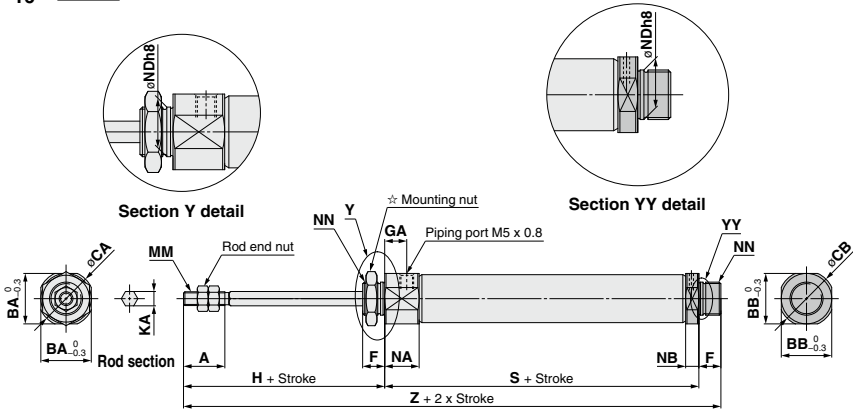

☆ For details of the mounting nut, refer to page 91.

Bore size	A	BA	BB	CA	CB	F	GA	H	KA	MM	NA	NB	NDh8	NN	S										Z										
															5 to 15 st	16 to 30 st	31 to 45 st	46 to 60 st	61 to 75 st	76 to 100 st	101 to 125 st	126 to 150 st	5 to 15 st	16 to 30 st	31 to 45 st	46 to 60 st	61 to 75 st	76 to 100 st	101 to 125 st	126 to 150 st					
10	15	15	15	17	17	8	8	28	4.2	M4 x 0.7	12.5	4.8	10 $_{-0.022}^0$	M10 x 1.0	48.5	56	68	80	—	—	—	—	—	—	—	—	—	—	—	—	—	—	—	—	—
16	15	18.3	18.3	20	20	8	8	28	5.2	M5 x 0.8	12.5	4.8	12 $_{-0.022}^0$	M12 x 1.0	48.5	57	69	81	87	111	129	141	141	141	84.5	93	105	117	123	147	165	177	—	—	—

CJ2K Series

Single Acting, Spring Extend: Double Clevis (D)

CJ2KD $\frac{10}{16}$ – Stroke TZ

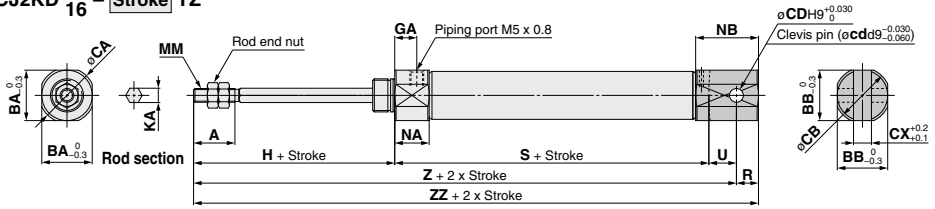

* A clevis pin and retaining rings are included.

Bore size	A	BA	BB	CA	CB	CD (cd)	CX	GA	H	KA	MM	NA	NB	R	U	S									
	5 to 15 st	16 to 30 st	31 to 45 st	46 to 60 st	61 to 75 st	76 to 100 st	101 to 125 st	126 to 150 st	5 to 15 st	16 to 30 st	31 to 45 st	46 to 60 st	61 to 75 st	76 to 100 st	101 to 125 st	126 to 150 st	5 to 15 st	16 to 30 st	31 to 45 st	46 to 60 st	61 to 75 st	76 to 100 st	101 to 125 st	126 to 150 st	
10	15	15	12	17	14	3.3	3.2	8	28	4.2	M4 x 0.7	12.5	17.8	5	8	48.5	56	68	80	—	—	—	—	—	—
16	15	18.3	18.3	20	20	5	6.5	8	28	5.2	M5 x 0.8	12.5	22.8	8	10	48.5	57	69	81	87	111	129	141	—	

Bore size	Z								ZZ							
	5 to 15 st	16 to 30 st	31 to 45 st	46 to 60 st	61 to 75 st	76 to 100 st	101 to 125 st	126 to 150 st	5 to 15 st	16 to 30 st	31 to 45 st	46 to 60 st	61 to 75 st	76 to 100 st	101 to 125 st	126 to 150 st
10	84.5	92	104	116	—	—	—	—	89.5	97	109	121	—	—	—	—
16	86.5	95	107	119	125	149	167	179	94.5	103	115	127	133	157	175	187

Single Acting, Spring Extend: Single Foot (L)

CJ2KL $\frac{10}{16}$ – Stroke TZ

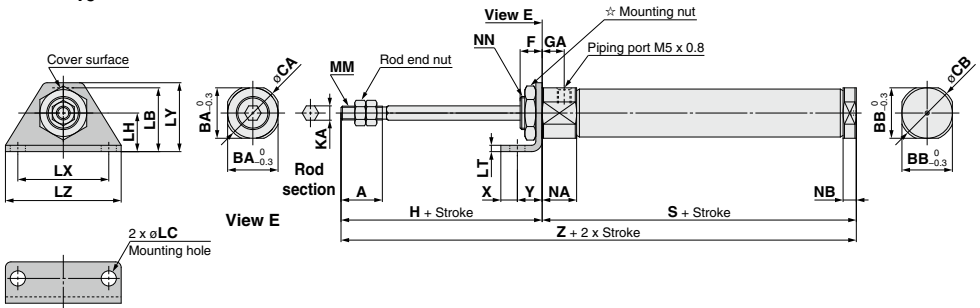

☆ For details of the mounting nut, refer to page 91.

Bore size	A	BA	BB	CA	CB	F	GA	H	KA	LB	LC	LH	LT	LX	LY	LZ	MM	NA	NB	NN
	10	15	15	12	17	14	8	8	28	4.2	21.5	5.5	14	2.3	33	25	42	M4 x 0.7	12.5	4.8
16	15	18.3	18.3	20	20	8	8	28	5.2	23	5.5	14	2.3	33	25	42	M5 x 0.8	12.5	4.8	M12 x 1.0

Bore size	S																X	Y	Z							
	5 to 15 st	16 to 30 st	31 to 45 st	46 to 60 st	61 to 75 st	76 to 100 st	101 to 125 st	126 to 150 st	5 to 15 st	16 to 30 st	31 to 45 st	46 to 60 st	61 to 75 st	76 to 100 st	101 to 125 st	126 to 150 st										
10	48.5	56	68	80	—	—	—	—	6	9	76.5	84	96	108	—	—	—	—	—	—						
16	48.5	57	69	81	87	111	129	141	6	9	76.5	85	97	109	115	139	157	169	—	—						

Single Acting, Spring Extend: Double Foot (M)

CJ2KM $\frac{10}{16}$ - Stroke TZ

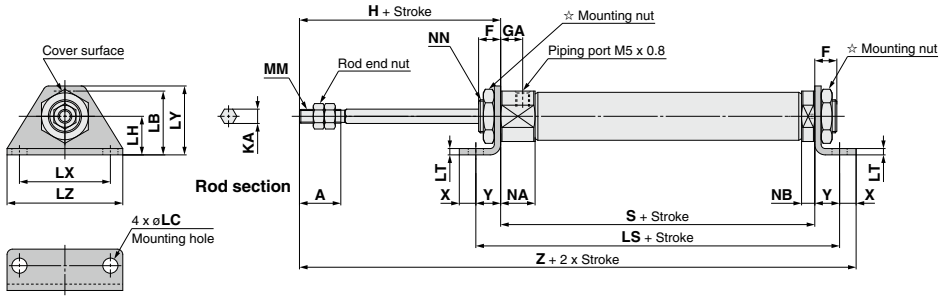

☆ For details of the mounting nut, refer to page 91.

Bore size	A	F	GA	H	KA	LB	LC	LH	LS								LT	LX	LY	LZ	MM	NA	NB	NN
									5 to 15 st	16 to 30 st	31 to 45 st	46 to 60 st	61 to 75 st	76 to 100 st	101 to 125 st	126 to 150 st								
10	15	8	8	28	4.2	21.5	5.5	14	66.5	74	86	98	—	—	—	2.3	33	25	42	M4 x 0.7	12.5	4.8	M10 x 1.0	
16	15	8	8	28	5.2	23	5.5	14	66.5	75	87	99	105	129	147	159	2.3	33	25	42	M5 x 0.8	12.5	4.8	M12 x 1.0

Bore size	S								X	Y	Z													
	5 to 15 st	16 to 30 st	31 to 45 st	46 to 60 st	61 to 75 st	76 to 100 st	101 to 125 st	126 to 150 st			5 to 15 st	16 to 30 st	31 to 45 st	46 to 60 st	61 to 75 st	76 to 100 st	101 to 125 st	126 to 150 st						
10	48.5	56	68	80	—	—	—	—	6	9	91.5	99	111	123	—	—	—	—	—	—	—	—	—	—
16	48.5	57	69	81	87	111	129	141	6	9	91.5	100	112	124	130	154	172	184	—	—	—	—	—	—

Single Acting, Spring Extend: Rod Flange (F)

CJ2KF $\frac{10}{16}$ - Stroke TZ

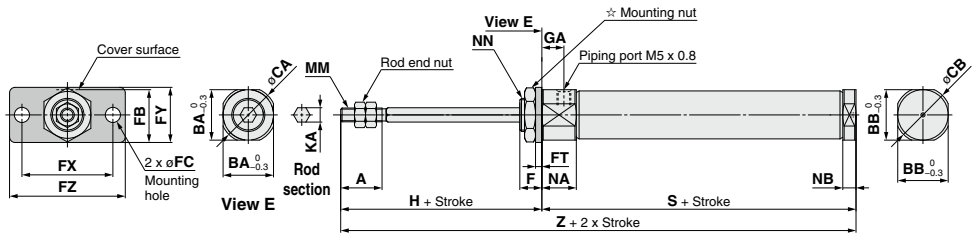

☆ For details of the mounting nut, refer to page 91.

Bore size	A	BA	BB	CA	CB	F	FB	FC	FT	FX	FY	FZ	GA	H	KA	MM	NA	NB	NN
16	15	18.3	18.3	20	20	8	19	5.5	2.3	33	20	42	8	28	5.2	M5 x 0.8	12.5	4.8	M12 x 1.0

Bore size	S								Z							
	5 to 15 st	16 to 30 st	31 to 45 st	46 to 60 st	61 to 75 st	76 to 100 st	101 to 125 st	126 to 150 st	5 to 15 st	16 to 30 st	31 to 45 st	46 to 60 st	61 to 75 st	76 to 100 st	101 to 125 st	126 to 150 st
10	48.5	56	68	80	—	—	—	—	76.5	84	96	108	—	—	—	—
16	48.5	57	69	81	87	111	129	141	76.5	85	97	109	115	139	157	169

CJ2K Series

Single Acting, Spring Extend: Head Flange (G)

CJ2KG $\frac{10}{16}$ - Stroke TZ

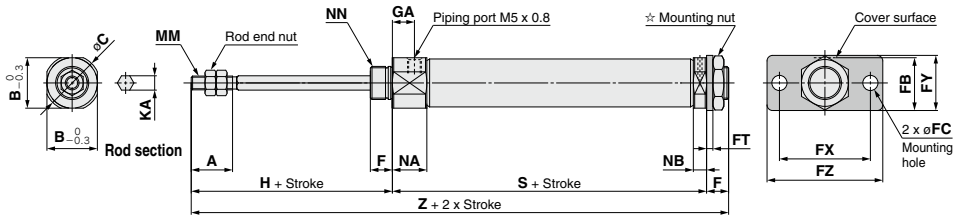

☆ For details of the mounting nut, refer to page 91.

[mm]

Bore size	A	B	C	F	FB	FC	FT	FX	FY	FZ	GA	H	KA	MM	NA	NB	NN
10	15	15	17	8	17.5	5.5	2.3	33	20	42	8	28	4.2	M4 x 0.7	12.5	4.8	M10 x 1.0
16	15	18.3	20	8	19	5.5	2.3	33	20	42	8	28	5.2	M5 x 0.8	12.5	4.8	M12 x 1.0

Bore size	S								Z							
	5 to 15 st	16 to 30 st	31 to 45 st	46 to 60 st	61 to 75 st	76 to 100 st	101 to 125 st	126 to 150 st	5 to 15 st	16 to 30 st	31 to 45 st	46 to 60 st	61 to 75 st	76 to 100 st	101 to 125 st	126 to 150 st
10	48.5	56	68	80	—	—	—	—	84.5	92	104	116	—	—	—	—
16	48.5	57	69	81	87	111	129	141	84.5	93	105	117	123	147	165	177

Air Cylinder: Built-in Speed Controller Type Double Acting, Single Rod

CJ2Z Series

ø10, ø16



How to Order

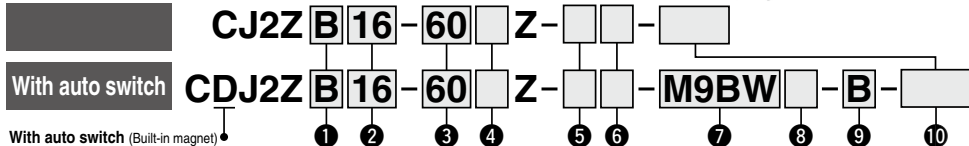

With auto switch (Built-in magnet)

1 Mounting

B	Basic
E	Double-side bossed
D	Double clevis
L	Single foot
M	Double foot
F	Rod flange
G	Head flange

*: Foot/Flange brackets are shipped together with the product, but not assembled.

2 Bore size

10	10 mm
16	16 mm

4 Head cover port location

Nil	Perpendicular to axis	
R	Axial	

*: For double clevis, the product is perpendicular to the cylinder axis.
*: For double-side bossed, the product is perpendicular to the cylinder axis.

3 Cylinder standard stroke [mm]

Refer to "Standard Strokes" on page 138.

5 Pivot bracket

Nil	None
N	Pivot bracket is shipped together with the product.

*: Only for the double clevis type
*: Pivot bracket is shipped together with the product, but not assembled.

6 Rod end bracket

Nil	None
V	Single knuckle joint
W**	Double knuckle joint
T	Rod end cap (Flat type)
U	Rod end cap (Round type)

*: Rod end bracket is shipped together with the product, but not assembled.
**: Refer to page 91 for the double knuckle joint (with one-touch connecting pin).

7 Auto switch

Nil	Without auto switch
-----	---------------------

*: For applicable auto switches, refer to the table below.

★ Enter the auto switch mounting type (A or B) even when a built-in magnet cylinder without an auto switch is required.

8 Number of auto switches

Nil	2 pcs.
S	1 pc.
n	"n" pcs.

9 Auto switch mounting type

A	Rail mounting
B	Band mounting

*: For rail mounting, screws and nuts for 2 auto switches come with the rail.

*: Refer to page 178 for auto switch mounting brackets.

10 Made to Order

Refer to page 138 for details.

*: Refer to "Ordering Example of Cylinder Assembly" on page 138.

Applicable Auto Switches/Refer to pages 1271 to 1365 for further information on auto switches.

Type	Special function	Electrical entry	Indicator light	Wiring (Output)	Load voltage		Auto switch model				Lead wire length [m]					Pre-wired connector	Applicable load
					DC	AC	Band mounting		Rail mounting		0.5 (Nil)	1 (L)	3 (Z)	5 (N)	None (N)		
							Perpendicular	In-line	Perpendicular	In-line							
Solid state auto switch	—	Grommet	—	3-wire (NPN)	5 V, 12 V	—	M9NV	M9N	M9NV	M9N	●	●	●	○	○	IC circuit	
				3-wire (PNP)			M9PV	M9P	M9PV	M9P	●	●	●	○	○		
	Diagnostic indication (2-color indicator)	Connector	Yes	2-wire	12 V	—	M9BV	M9B	M9BV	M9B	●	●	○	○	○	—	
				3-wire (NPN)	5 V, 12 V	—	M9NV	M9NW	M9NV	M9NW	●	●	●	○	○	IC circuit	
	Water resistant (2-color indicator)	Grommet	—	2-wire	12 V	—	M9PW	M9P	M9PW	M9P	●	●	●	○	○	—	
				3-wire (NPN)	5 V, 12 V	—	M9BW	M9B	M9BW	M9B	●	●	●	○	○	—	
	With diagnostic output (2-color indicator)	Grommet	—	3-wire (PNP)	5 V, 12 V	—	M9AV ^{*1}	M9A ^{*1}	M9AV ^{*1}	M9A ^{*1}	○	○	○	○	○	IC circuit	
2-wire				12 V	—	M9PAV ^{*1}	M9PA ^{*1}	M9PAV ^{*1}	M9PA ^{*1}	○	○	●	○	○	—		
Reed auto switch	—	Grommet	Yes	4-wire (NPN)	5 V, 12 V	—	M9BAV ^{*1}	M9BA ^{*1}	M9BAV ^{*1}	M9BA ^{*1}	○	○	●	○	○	IC circuit	
				—	5 V	—	A96V	A96	A96V	A96	●	—	—	—	—	IC circuit	
	Diagnostic indication (2-color indicator)	Connector	No	2-wire	24 V	12 V	—	—	—	A72H	●	●	●	—	—	—	
							—	200 V	—	A72	A72H	●	●	●	—	—	—
	—	Grommet	No	2-wire	24 V	12 V	100 V or less	A93V ^{*2}	A93	A93V ^{*2}	A93	●	●	●	—	—	
							—	A90V	A90	A90V	A90	●	●	●	—	—	IC circuit
	—	Grommet	Yes	2-wire	24 V	24 V or less	—	C73C	A73C	—	—	●	●	●	—	—	
—							C80C	A80C	—	—	●	●	●	—	—	IC circuit	
—	Grommet	Yes	2-wire	24 V	24 V or less	—	—	A79W	—	—	●	●	●	—	—		
						—	—	—	—	—	●	●	●	—	—	—	

*1: Water resistant type auto switches can be mounted on the above models, but in such case SMC cannot guarantee water resistance.

*2: 1 m type lead wire is only applicable to D-A93.

*: Lead wire length symbols: 0.5 m..... Nil (Example) M9NV 5 m..... Z (Example) M9NVZ
1 m..... M (Example) M9NWM None..... N (Example) H7CN
3 m..... L (Example) M9NWL

*: Since there are other applicable auto switches than listed, refer to page 179 for details.

*: Solid state auto switches marked with "○" are produced upon receipt of order.

*: The D-A9□/M9□/A7□/A80□/F7□/J7□ auto switches are shipped together, but not assembled. (For band mounting, only auto switch mounting brackets are assembled before being shipped.)



CJ2Z Series

Space-saving air cylinder with speed controller built-in cylinder cover



Symbol

Double acting, Single rod, Rubber bumper

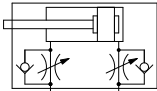

Made to Order: Individual Specifications
(For details, refer to page 180.)

Symbol	Specifications
-X446	PTFE grease

Made to Order

[Click here for details](#)

Symbol	Specifications
-XA□	Change of rod end shape
-XC51	With hose nipple
-XC85	Grease for food processing equipment

⚠ Precautions

Refer to page 183 before handling.

Ordering Example of Cylinder Assembly

Cylinder model: CDJ2ZD16-60Z-NW-M9BW-B

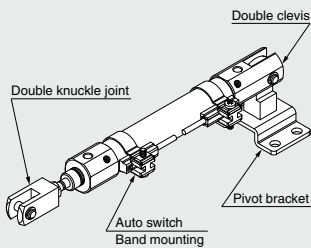

Mounting D: Double clevis
Pivot bracket N: Yes
Rod end bracket W: Double knuckle joint
Auto switch D-M9BW: 2 pcs.
Auto switch mounting B: Band mounting

*: Pivot bracket, double knuckle joint and auto switch are shipped together with the product, but not assembled.

Specifications

Bore size [mm]	10	16
Action	Double acting, Single rod	
Fluid	Air	
Proof pressure	1 MPa	
Maximum operating pressure	0.7 MPa	
Minimum operating pressure	0.06 MPa	
Ambient and fluid temperature	Without auto switch: -10°C to 70°C (No freezing) With auto switch: -10°C to 60°C	
Cushion	Rubber bumper	
Lubrication	Not required (Non-lube)	
Stroke length tolerance	+1.0 0	
Speed controller	Built-in	
Piston speed	50 to 750 mm/s	
Allowable kinetic energy	0.035 J	0.090 J

Standard Strokes

Bore size	Standard stroke	Maximum manufacturable stroke [mm]
10	15, 30, 45, 60, 75, 100, 125, 150	400
16	15, 30, 45, 60, 75, 100, 125, 150, 175, 200	400

- *: Manufacture of intermediate strokes in 1 mm increments is possible. (Spacers are not used.)
- *: Applicable strokes should be confirmed according to the usage. For details, refer to "Air Cylinders Model Selection" on pages 8 to 19. In addition, the products that exceed the standard stroke might not be able to fulfill the specifications due to the deflection etc.

Mounting and Accessories

(Refer to page 68 for the list of brackets and page 91 for details about part numbers and dimensions.)

- ...Mounted on the product. ○...Can be ordered within the cylinder model. △...Order separately.

Mounting		Basic	Foot	Flange	Double clevis	Double clevis (including T-bracket)
Standard	Mounting nut	●	●	●	—	—
	Rod end nut	●	●	●	●	●
	Clevis pin (including retaining rings)	—	—	—	●	●
	Single knuckle joint	○	○	○	○	○
Option	Double knuckle joint (including a pin and retaining rings)	○	○	○	○	○
	Double knuckle joint (With one-touch connecting pin)	△	△	△	△	△
	Rod end cap (Flat/Round type)	○	○	○	○	○
	Pivot bracket (T-bracket)	—	—	—	○	●

- *: Stainless steel mounting brackets and accessories are also available. Refer to page 92 for details.

Mounting Brackets/Part No.

Mounting bracket	Bore size [mm]	
	10	16
Foot	CJ-L010C	CJ-L016C
Flange	CJ-F010C	CJ-F016C
Pivot bracket (T-bracket)*1	CJ-T010C	CJ-T016C

- *1: The pivot bracket (T-bracket) is used with double clevis (D).

Refer to pages 172 to 179 for cylinders with auto switches.

- Auto switch proper mounting position (detection at stroke end) and its mounting height
- Minimum stroke for auto switch mounting
- Operating range
- Auto switch mounting brackets/Part no.

Weights

		[g]	
Bore size [mm]		10	16
Basic weight (When the stroke is zero)	Basic	36	61
	Axial piping	36	61
	Double clevis (including clevis pin)	40	68
	Head-side bossed	37	63
Additional weight per 15 mm of stroke		4	7
	Single foot	8	25
Mounting bracket weight	Double foot	16	50
	Rod flange	5	13
	Head flange	5	13
	Single knuckle joint	17	23
Accessories	Double knuckle joint (including knuckle pin)	25	21
	Double knuckle joint (With one-touch connecting pin)	26	22
	Rod end cap (Flat type)	1	2
	Rod end cap (Round type)	1	2
	Pivot bracket (T-bracket)	32	50

∗: Mounting nut and rod end nut are included in the basic weight.

∗∗: Mounting nut is not included in the basic weight for the double clevis.

Calculation:

Example) **CJ2ZL10-45Z**

- Basic weight 36 (ø10)
 - Additional weight 4/15 stroke
 - Cylinder stroke 45 stroke
 - Mounting bracket weight ... 8 (Single foot)
- $36 + 4/15 \times 45 + 8 = 56 \text{ g}$

Construction (Not able to disassemble)

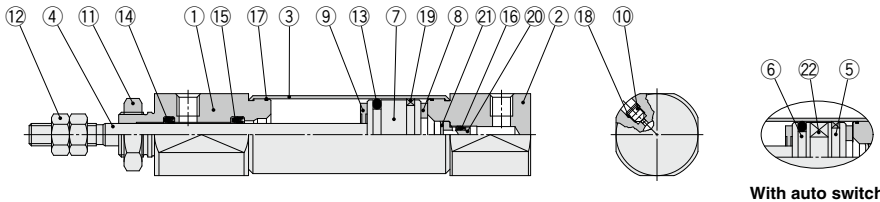

Component Parts

No.	Description	Material	Note
1	Rod cover	Aluminum alloy	
2	Head cover	Aluminum alloy	
3	Cylinder tube	Stainless steel	
4	Piston rod	Stainless steel	
5	Piston A	Aluminum alloy	
6	Piston B	Aluminum alloy	
7	Piston	Aluminum alloy	
8	Bumper A	Urethane	
9	Bumper B	Urethane	
10	Speed controller needle	Carbon steel	
11	Mounting nut	Rolled steel	

No.	Description	Material	Note
12	Rod end nut	Rolled steel	
13	Piston seal	NBR	
14	Rod seal	NBR	
15	Check seal A	NBR	
16	Check seal B	NBR	
17	Tube gasket	NBR	
18	Needle seal	NBR	
19	Wear ring	Resin	
20	Check seal sleeve	Aluminum alloy	
21	Retaining ring	Carbon tool steel	
22	Magnet	—	

CJ2Z Series

Basic (B)

CJ2ZB $\frac{10}{16}$ – Stroke Head cover port location Z

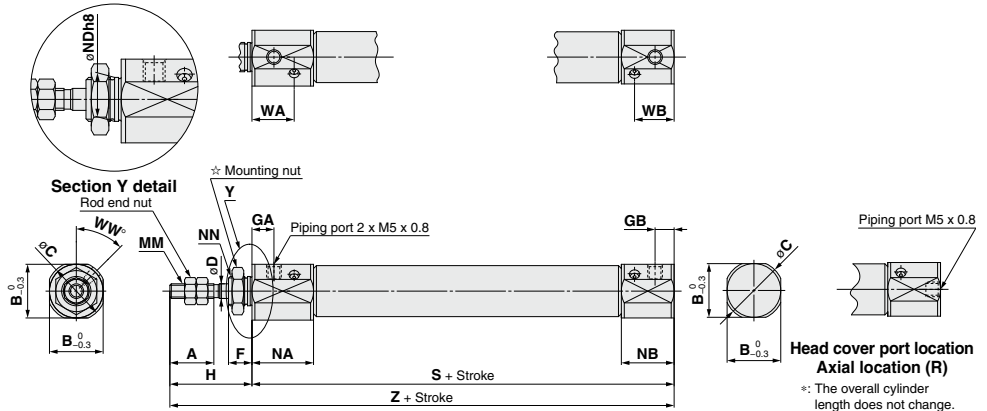

☆ For details of the mounting nut, refer to page 91.

Bore size	A	B	C	D	F	GA	GB	H	MM	NA	NB	NDh8	NN	WA	WB	WW	S	Z
																		[mm]
10	15	15	17	4	8	7.5	6.5	28	M4 x 0.7	21	18	8 ⁰ _{-0.022}	M8 x 1.0	14.4	13.5	45	63	91
16	15	18.3	20	5	8	7.5	6.5	28	M5 x 0.8	21	18	10 ⁰ _{-0.022}	M10 x 1.0	14.4	13.5	45	64	92

Double-side Bossed (E)

CJ2ZE $\frac{10}{16}$ – Stroke Z

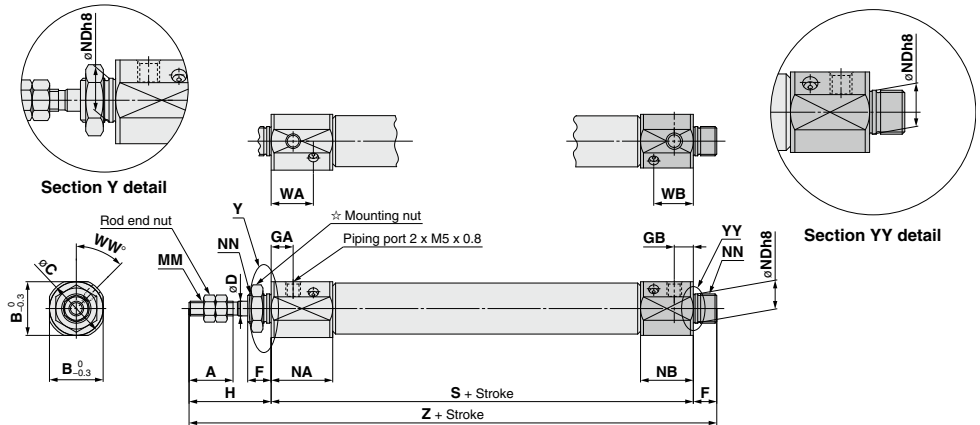

☆ For details of the mounting nut, refer to page 91.

Bore size	A	B	C	D	F	GA	GB	H	MM	NA	NB	NDh8	NN	WA	WB	WW	S	Z
																		[mm]
10	15	15	17	4	8	7.5	6.5	28	M4 x 0.7	21	18	8 ⁰ _{-0.022}	M8 x 1.0	14.4	13.5	45	63	99
16	15	18.3	20	5	8	7.5	6.5	28	M5 x 0.8	21	18	10 ⁰ _{-0.022}	M10 x 1.0	14.4	13.5	45	64	100

Double Clevis (D)

CJ2ZD $\frac{10}{16}$ – Stroke Z

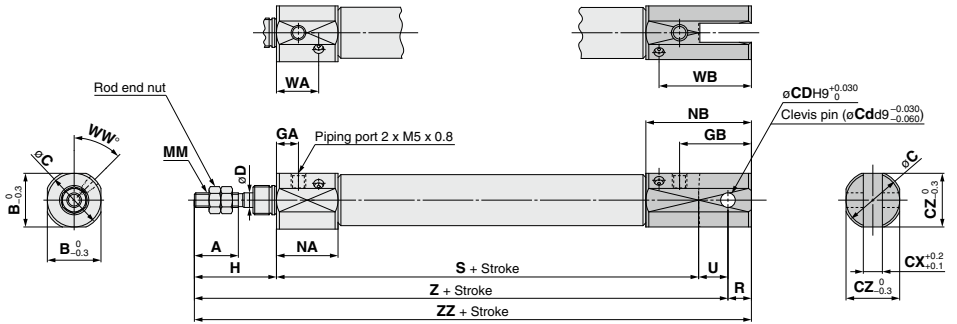

Bore size	A	B	C	CD	CX	CZ	D	GA	GB	H	MM	NA	NB	R	U	WA	WB	WW	S	Z	ZZ
10	15	15	17	3.3	3.2	15	4	7.5	19.5	28	M4 x 0.7	21	31	5	8	14.4	26.5	45	63	99	104
16	15	18.3	20	5	6.5	18.3	5	7.5	24.5	28	M5 x 0.8	21	36	8	10	14.4	31.5	45	64	102	110

Single Foot (L)

CJ2ZL $\frac{10}{16}$ – Stroke Head cover port location Z

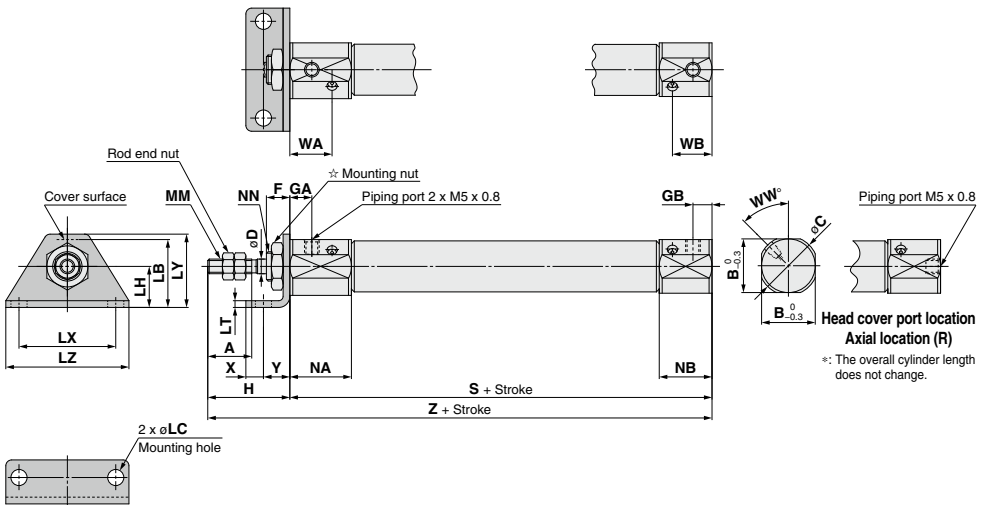

☆ For details of the mounting nut, refer to page 91.

Bore size	A	B	C	D	F	GA	GB	H	LB	LC	LH	LT	LX	LY	LZ	MM	NA	NB	NN	WA	WB	WW	S	X	Y	Z
10	15	15	17	4	8	7.5	6.5	28	15	4.5	9	1.6	24	16.5	32	M4 x 0.7	21	18	M8 x 1.0	14.4	13.5	45	63	5	7	91
16	15	18.3	20	5	8	7.5	6.5	28	23	5.5	14	2.3	33	25	42	M5 x 0.8	21	18	M10 x 1.0	14.4	13.5	45	64	6	9	92

CJ2Z Series

Double Foot (M)

CJ2ZM $\frac{10}{16}$ - Stroke Z

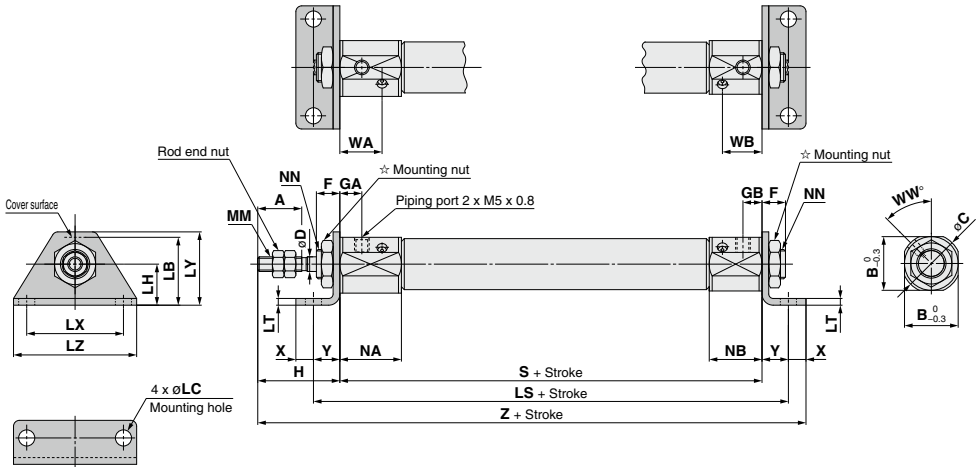

☆ For details of the mounting nut, refer to page 91.

Bore size	A	B	C	D	F	GA	GB	H	LB	LC	LH	LS	LT	LX	LY	LZ	MM	NA	NB	NN	WA	WB	WW	S	X	Y	Z
10	15	15	17	4	8	7.5	6.5	28	15	4.5	9	77	1.6	24	16.5	32	M4 x 0.7	21	18	M8 x 1.0	14.4	13.5	45	63	5	7	103
16	15	18.3	20	5	8	7.5	6.5	28	23	5.5	14	82	2.3	33	25	42	M5 x 0.8	21	18	M10 x 1.0	14.4	13.5	45	64	6	9	107

Rod Flange (F)

CJ2ZF $\frac{10}{16}$ - Stroke Head cover port location Z

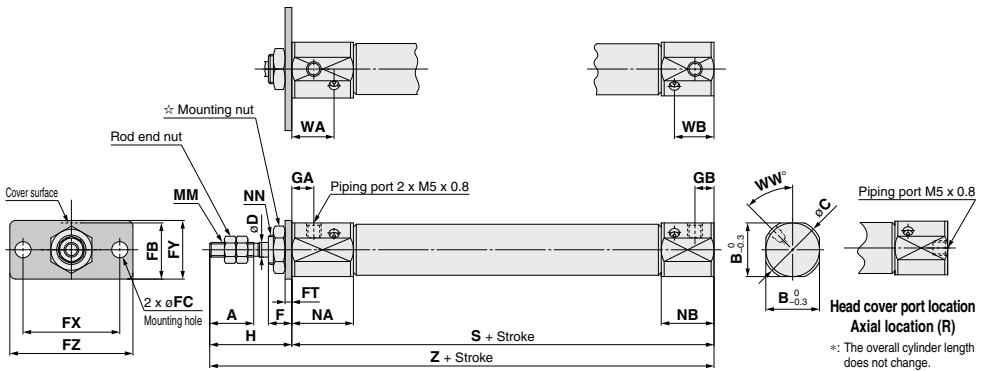

☆ For details of the mounting nut, refer to page 91.

Bore size	A	B	C	D	F	FB	FC	FT	FX	FY	FZ	GA	GB	H	MM	NA	NB	NN	WA	WB	WW	S	Z
10	15	15	17	4	8	13	4.5	1.6	24	14	32	7.5	6.5	28	M4 x 0.7	21	18	M8 x 1.0	14.4	13.5	45	63	91
16	15	18.3	20	5	8	19	5.5	2.3	33	20	42	7.5	6.5	28	M5 x 0.8	21	18	M10 x 1.0	14.4	13.5	45	64	92

Head Flange (G)

CJ2ZG $\frac{10}{16}$ - Stroke Z

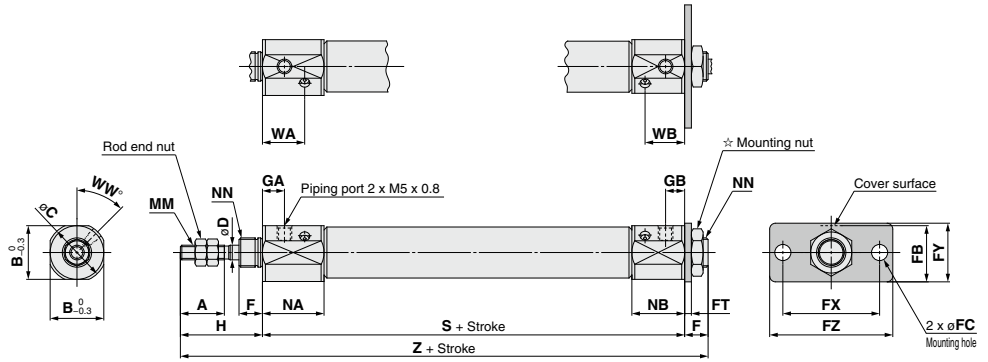

☆ For details of the mounting nut, refer to page 91.

Bore size	[mm]																						
	A	B	C	D	F	FB	FC	FT	FX	FY	FZ	GA	GB	H	MM	NA	NB	NN	WA	WB	WW	S	Z
10	15	15	17	4	8	13	4.5	1.6	24	14	32	7.5	6.5	28	M4 x 0.7	21	18	M8 x 1.0	14.4	13.5	45	63	99
16	15	18.3	20	5	8	19	5.5	2.3	33	20	42	7.5	6.5	28	M5 x 0.8	21	18	M10 x 1.0	14.4	13.5	45	64	100

Air Cylinder: Built-in Speed Controller Type Double Acting, Double Rod

CJ2ZW Series



ø10, ø16



How to Order

With auto switch

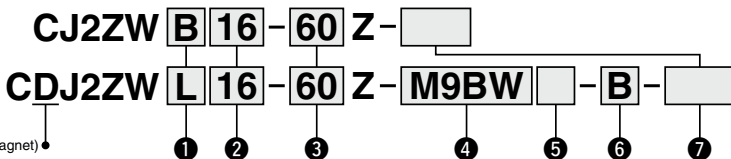

With auto switch (Built-in magnet)

1 Mounting

B	Basic
L	Foot
F	Flange

*: Foot/Flange brackets are shipped together with the product, but not assembled.

2 Bore size

10	10 mm
16	16 mm

3 Cylinder standard stroke [mm]

Refer to "Standard Strokes" on page 145.

4 Auto switch

Nil	Without auto switch
------------	---------------------

*: For applicable auto switches, refer to the table below.

★ Enter the auto switch mounting type (A or B) even when a built-in magnet cylinder without an auto switch is required.

5 Number of auto switches

Nil	2 pcs.
S	1 pc.
n	"n" pcs.

6 Auto switch mounting type

A	Rail mounting
B	Band mounting

*: For rail mounting, screws and nuts for 2 auto switches come with the rail.

*: Refer to page 178 for auto switch mounting brackets.

7 Made to Order

Refer to page 145 for details.

Applicable Auto Switches/Refer to pages 1271 to 1365 for further information on auto switches.

Type	Special function	Electrical entry	Indicator light	Wiring (Output)	Load voltage		Auto switch model				Lead wire length [m]					Pre-wired connector	Applicable load	
					DC	AC	Band mounting		Rail mounting		0.5 (Nil)	1 (M)	3 (L)	5 (Z)	None (N)			
							Perpendicular	In-line	Perpendicular	In-line								
Solid state auto switch	—	Grommet	No	3-wire (NPN)	5 V, 12 V	—	M9NV	M9N	M9NV	M9N	●	●	●	○	○	IC circuit	Relay, PLC	
				3-wire (PNP)			M9PV	M9P	M9PV	M9P	●	●	●	○	○			
		Connector	No	2-wire	M9BV	M9B	M9BV	M9B	●	●	●	○	○	○	○	—		
				—	H7C	J79C	—	●	—	●	●	—	—	—	—			
	Diagnostic indication (2-color indicator)	Grommet	Yes	3-wire (NPN)	5 V, 12 V	—	M9NWV	M9NW	M9NWV	M9NW	●	●	●	○	○	IC circuit		
				3-wire (PNP)			M9PWV	M9PW	M9PWV	M9PW	●	●	●	○	○	IC circuit		
		Connector	No	2-wire	M9BWV	M9BW	M9BWV	M9BW	●	●	●	○	○	○	—			
				—	H7NF	—	—	●	—	●	●	—	—	—	—			
Water resistant (2-color indicator)	Grommet	No	3-wire (NPN)	5 V, 12 V	—	M9NAV ^{*1}	M9NA ^{*1}	M9NAV ^{*1}	M9NA ^{*1}	○	○	●	○	○	IC circuit			
			3-wire (PNP)			M9PAV ^{*1}	M9PA ^{*1}	M9PAV ^{*1}	M9PA ^{*1}	○	○	●	○	○	IC circuit			
	Connector	No	2-wire	M9BAV ^{*1}	M9BA ^{*1}	M9BAV ^{*1}	M9BA ^{*1}	○	○	○	○	○	○	—				
			—	H7NF	—	F79F	●	—	●	●	—	—	—	IC circuit				
Reed auto switch	—	Grommet	Yes	3-wire (NPN equivalent)	—	—	A96V	A96	A96V	A96	●	—	●	—	—	IC circuit	Relay, PLC	
							—	—	A72	A72H	●	—	●	—	—	—		
							—	200 V	—	—	—	—	—	—	—	—		—
		Connector	No	2-wire	24 V	12 V	100 V or less	A93V ^{*2}	A93	A93V ^{*2}	A93	●	●	●	—	—		—
							—	A90V	A90	A90V	A90	●	—	●	—	—		IC circuit
							—	—	C73C	A73C	—	●	—	●	●	—		—
Grommet	Yes	2-wire	24 V	—	24 V or less	—	C80C	A80C	—	●	—	●	●	—	IC circuit			
					—	—	A79W	—	●	—	●	—	—	—				
					—	—	—	—	●	—	●	—	—	—	—			
Diagnostic indication (2-color indicator)	Grommet	No	—	—	—	—	—	—	—	—	—	—	—	—	—			

*1: Water resistant type auto switches can be mounted on the above models, but in such case SMC cannot guarantee water resistance. Please contact SMC regarding water resistant types with the above model numbers.

*2: 1 m type lead wire is only applicable to D-A93.

*: Lead wire length symbols: 0.5 m..... Nil (Example) M9NW
1 m..... M (Example) M9NWM
3 m..... L (Example) M9NWL
5 m..... Z (Example) M9NWX
None..... N (Example) H7CN

*: Since there are other applicable auto switches than listed, refer to page 179 for details.

*: Solid state auto switches marked with "○" are produced upon receipt of order.

*: The D-A9□/M9□/A7□/A8□/F7□/J7□ auto switches are shipped together, but not assembled. (For band mounting, only auto switch mounting brackets are assembled before being shipped.)

Space-saving air cylinder with speed controller built-in cylinder cover



Symbol

Double acting, Double rod, Rubber bumper

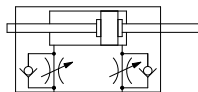

Made to Order: Individual Specifications
(For details, refer to page 180.)

Symbol	Specifications
-X446	PTFE grease

Made to Order

[Click here for details](#)

Symbol	Specifications
-XA□	Change of rod end shape
-XC51	With hose nipple
-XC85	Grease for food processing equipment

⚠ Precautions

Refer to page 183 before handling.

Specifications

Bore size [mm]	10	16
Action	Double acting, Double rod	
Fluid	Air	
Proof pressure	1 MPa	
Maximum operating pressure	0.7 MPa	
Minimum operating pressure	0.1 MPa	
Ambient and fluid temperature	Without auto switch: -10°C to 70°C (No freezing) With auto switch: -10°C to 60°C	
Cushion	Rubber bumper	
Lubrication	Not required (Non-lube)	
Stroke length tolerance	+1.0 0	
Speed controller	Built-in	
Piston speed	50 to 750 mm/s	
Allowable kinetic energy	0.035 J	0.090 J

Standard Strokes

Bore size	Standard stroke [mm]
10	15, 30, 45, 60, 75, 100, 125, 150
16	15, 30, 45, 60, 75, 100, 125, 150, 175, 200

- *: Manufacture of intermediate strokes in 1 mm increments is possible. (Spacers are not used.)
- *: Please consult with SMC for strokes which exceed the standard stroke length.
- *: Applicable strokes should be confirmed according to the usage. For details, refer to "Air Cylinders Model Selection" on pages 8 to 19. In addition, the products that exceed the standard stroke might not be able to fulfill the specifications due to the deflection etc.

Mounting and Accessories (Refer to page 68 for the list of brackets and page 91 for details about part numbers and dimensions.)

●●● Mounted on the product. ○○○ Please order separately.

Mounting	Basic	Foot	Flange
	●	●	●
Standard	●	●	●
Option	○	○	○
Option	○	○	○
Option	○	○	○

- *: Stainless steel mounting brackets and accessories are also available.
Refer to page 92 for details.

Mounting Brackets/Part No.

Mounting bracket	Bore size [mm]	
	10	16
Foot	CJ-L010C	CJ-L016C
Flange	CJ-F010C	CJ-F016C

Refer to pages 172 to 179 for cylinders with auto switches.

- Auto switch proper mounting position (detection at stroke end) and its mounting height
- Minimum stroke for auto switch mounting
- Operating range
- Auto switch mounting brackets/Part no.

CJ2ZW Series

Weights

Bore size [mm]		10	16
Basic weight (When the stroke is zero)	Basic	36	61
	Additional weight per 15 mm of stroke	4.5	7.5
Mounting bracket weight	Double foot	16	50
	Head flange	5	13
Accessories	Single knuckle joint	17	23
	Double knuckle joint (including knuckle pin)	25	21
	Double knuckle joint (With one-touch connecting pin)	26	22
	Rod end cap (Flat type)	1	2
	Rod end cap (Round type)	1	2

※: Mounting nut and rod end nut are included in the basic weight.

Calculation:

Example) **CJ2ZWL10-45Z**

- Basic weight36 (ø10)
 - Additional weight4.5/15 stroke
 - Cylinder stroke.....45 stroke
 - Mounting bracket weight...16 (Double foot)
- $36 + 4.5/15 \times 45 + 16 = 65.5 \text{ g}$

Construction (Not able to disassemble)

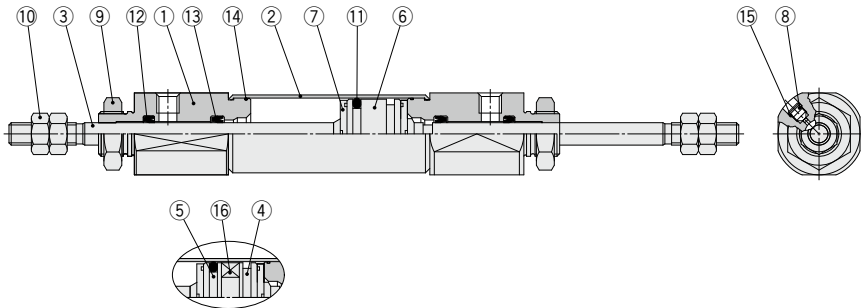

With auto switch

Component Parts

No.	Description	Material	Note
1	Rod cover	Aluminum alloy	
2	Cylinder tube	Stainless steel	
3	Piston rod	Stainless steel	
4	Piston A	Aluminum alloy	
5	Piston B	Aluminum alloy	
6	Piston	Aluminum alloy	
7	Bumper	Urethane	
8	Speed controller needle	Carbon steel	

No.	Description	Material	Note
9	Mounting nut	Rolled steel	
10	Rod end nut	Rolled steel	
11	Piston seal	NBR	
12	Rod seal	NBR	
13	Check seal	NBR	
14	Tube gasket	NBR	
15	Needle seal	NBR	
16	Magnet	—	

Basic (B)

CJ2ZWB $\frac{10}{16}$ - Stroke Z

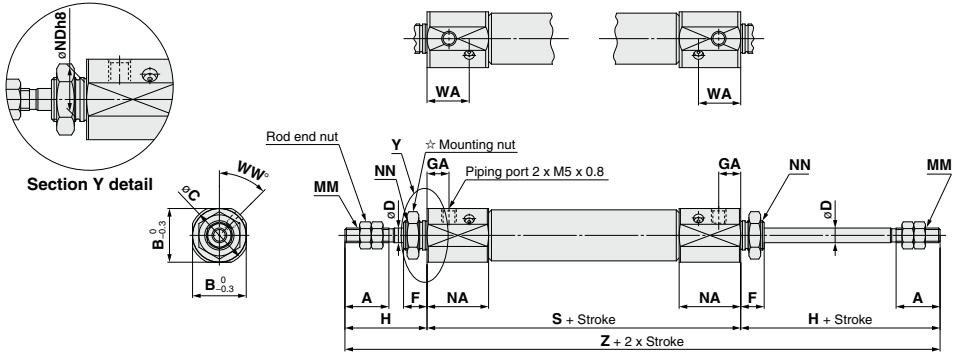

☆ For details of the mounting nut, refer to page 91.

Bore size	A	B	C	D	F	GA	H	MM	NA	NDh8	NN	WA	WW	S	Z
10	15	15	17	4	8	7.5	28	M4 x 0.7	21	8 $_{-0.022}^0$	M8 x 1.0	14.4	45	66	122
16	15	18.3	20	5	8	7.5	28	M5 x 0.8	21	10 $_{-0.022}^0$	M10 x 1.0	14.4	45	67	123

Foot (L)

CJ2ZWL $\frac{10}{16}$ - Stroke Z

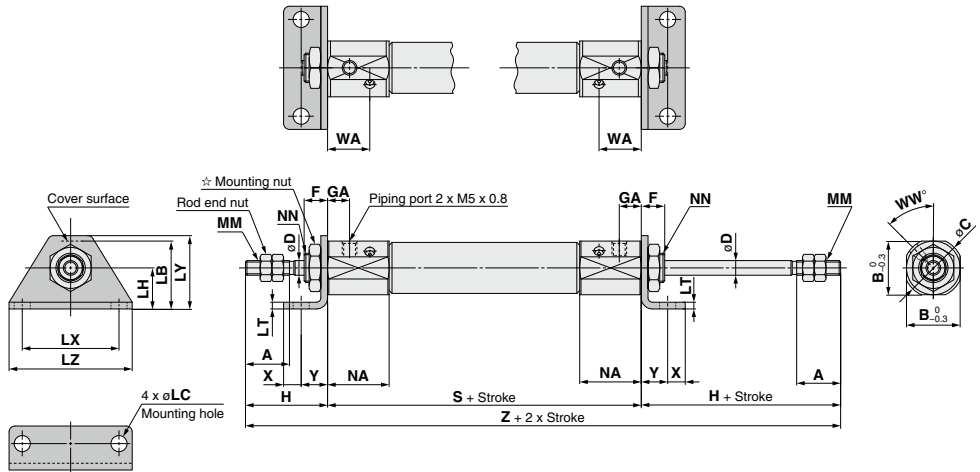

☆ For details of the mounting nut, refer to page 91.

Bore size	A	B	C	D	F	GA	H	LB	LC	LH	LT	LX	LY	LZ	NN	NA	NN	WA	WW	S	X	Y	Z
10	15	15	17	4	8	7.5	28	15	4.5	9	1.6	24	16.5	32	M4 x 0.7	21	M8 x 1.0	14.4	45	66	5	7	122
16	15	18.3	20	5	8	7.5	28	23	5.5	14	2.3	33	25	42	M5 x 0.8	21	M10 x 1.0	14.4	45	67	6	9	123

CJ2ZW Series

Flange (F)

CJ2ZWF $\frac{10}{16}$ - Stroke Z

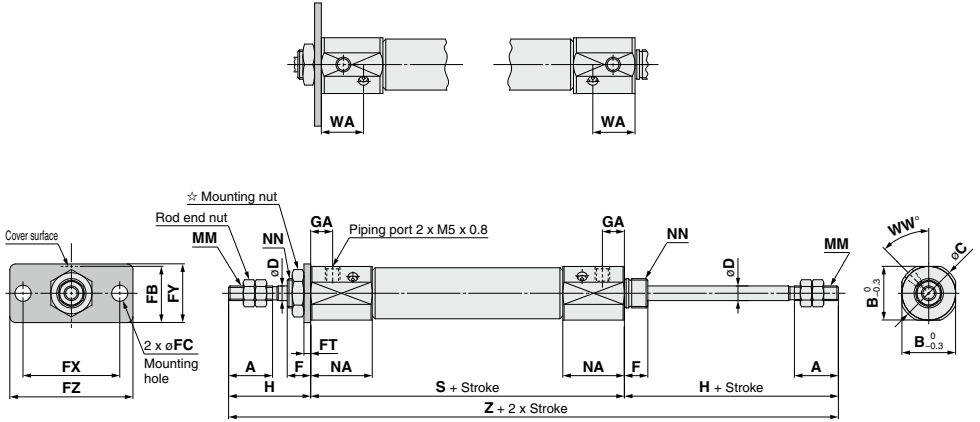

☆ For details of the mounting nut, refer to page 91.

Bore size	[mm]																			
	A	B	C	D	F	FB	FC	FT	FX	FY	FZ	GA	H	MM	NA	NN	WA	WW	S	Z
10	15	15	17	4	8	13	4.5	1.6	24	14	32	7.5	28	M4 x 0.7	21	M8 x 1.0	14.4	45	66	122
16	15	18.3	20	5	8	19	5.5	2.3	33	20	42	7.5	28	M5 x 0.8	21	M10 x 1.0	14.4	45	67	123

Air Cylinder: Direct Mount Type Double Acting, Single Rod

CJ2R Series

ø10, ø16

RoHS



How to Order

CJ2RA 16 - 60 □ Z - □ - □

With auto switch

CDJ2RA 16 - 60 □ Z - □ - M9BW □ - B - □

With auto switch (Built-in magnet)*

1 Mounting

A	Bottom mounting
---	-----------------

2 Bore size

10	10 mm
16	16 mm

3 Cylinder standard stroke [mm]

Refer to "Standard Strokes" on page 150.

4 Head cover port location

Nil	Perpendicular to axis	
	Axial	

5 Rod end bracket

Nil	None
V	Single knuckle joint
W**	Double knuckle joint
T	Rod end cap (Flat type)
U	Rod end cap (Round type)

*: Rod end bracket is shipped together with the product, but not assembled.
**: Refer to page 91 for the double knuckle joint (with one-touch connecting pin).

6 Auto switch

Nil	Without auto switch
-----	---------------------

*: For applicable auto switches, refer to the table below.
* Star Enter the auto switch mounting type (A or B) even when a built-in magnet cylinder without an auto switch is required.

7 Number of auto switches

Nil	2 pcs.
S	1 pc.
n	"n" pcs.

8 Auto switch mounting type

A	Rail mounting
B	Band mounting

*: For rail mounting, screws and nuts for 2 auto switches come with the rail.
*: Refer to page 178 for auto switch mounting brackets.

9 Made to Order

Refer to page 150 for details.

*: Refer to "Ordering Example of Cylinder Assembly" on page 150.

Applicable Auto Switches/Refer to pages 1271 to 1365 for further information on auto switches.

Type	Special function	Electrical entry	Indicator light	Wiring (Output)	Load voltage		Auto switch model				Lead wire length [m]					Pre-wired connector	Applicable load	
					DC	AC	Band mounting		Rail mounting		0.5 (Nil)	1 (M)	3 (L)	5 (Z)	None (N)			
							Perpendicular	In-line	Perpendicular	In-line								
Solid state auto switch	—	Grommet	—	3-wire (NPN)	5 V, 12 V	—	M9NV	M9N	M9NV	M9N	●	●	●	○	○	IC circuit	Relay, PLC	
				3-wire (PNP)			M9PV	M9P	M9PV	M9P	●	●	●	○	○			
		Connector	2-wire	—	H7C	J79C	—	●	●	●	○	○	—					
	Diagnostic indication (2-color indicator)	Grommet	Yes	3-wire (NPN)	5 V, 12 V	—	M9NVV	M9NV	M9NVV	M9NV	●	●	●	○	○	IC circuit		
				3-wire (PNP)			M9PVV	M9PV	M9PVV	M9PV	●	●	●	○	○			
		Connector	2-wire	—	M9BWW	M9BW	M9BWW	M9BW	●	●	●	○	○	—				
	Water resistant (2-color indicator)	Grommet	—	3-wire (NPN)	5 V, 12 V	—	M9NAV*1	M9NA*1	M9NAV*1	M9NA*1	○	○	●	○	○	IC circuit		
				3-wire (PNP)			M9PAV*1	M9PA*1	M9PAV*1	M9PA*1	○	○	●	○	○			
		Connector	2-wire	—	M9BAV*1	M9BA*1	M9BAV*1	M9BA*1	○	○	○	○	○	—				
With diagnostic output (2-color indicator)	Grommet	—	4-wire (NPN)	5 V, 12 V	—	—	H7NF	—	F79F	●	●	○	○	○	IC circuit			
			Connector			—	—	—	—	—	—	—	—	—		—		
	Reed auto switch	—	Grommet	Yes	3-wire (NPN equivalent)	5 V	—	A96V	A96	A96V	A96	●	●	—	—	IC circuit	Relay, PLC	
—					—			—	A72	A72H	●	●	—	—	—			
Connector			No	2-wire	24 V	12 V	—	100 V	A93V*2	A93	A93V*2	A93	●	●	●	—		IC circuit
								100 V or less	A90V	A90	A90V	A90	●	●	●	—		
								24 V or less	—	C73C	A73C	—	●	●	●	●		
Grommet			Yes	2-wire	24 V	—	—	—	C80C	A80C	—	●	●	●	●	IC circuit		
								—	—	A79W	—	●	●	●	●			—

*1: Water resistant type auto switches can be mounted on the above models, but in such case SMC cannot guarantee water resistance.

*2: Please contact SMC regarding water resistant types with the above model numbers.

*3: 1 m type lead wire is only applicable to D-A93.

*4: Lead wire length symbols: 0.5 m..... Nil (Example) M9NV
1 m..... M (Example) M9NVW
3 m..... L (Example) M9NVLL
5 m..... Z (Example) M9NVZZ

*5: Since there are other applicable auto switches than listed, refer to page 179 for details.

*6: Solid state auto switches marked with "○" are produced upon receipt of order.

*7: The D-A9□/M9□/A7□/A8□/□/□/□/□ auto switches are shipped together, but not assembled. (For band mounting, only auto switch mounting brackets are assembled before being shipped.)

CJ2R Series

The CJ2R direct mount cylinder can be installed directly through the use of a square rod cover.

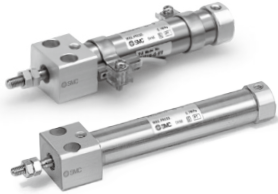

Symbol

Double acting, Single rod, Rubber bumper

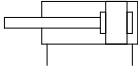

Made to Order
Made to Order: Individual Specifications
(For details, refer to page 180.)

Symbol	Specifications
-X446	PTFE grease

Made to Order

[Click here for details](#)

Symbol	Specifications
-XA	Change of rod end shape
-XC9	Adjustable stroke cylinder/Adjustable retraction type
-XC22	Fluororubber seal
-XC51	With hose nipple
-XC85	Grease for food processing equipment

⚠ Precautions

Refer to page 183 before handling.

Ordering Example of Cylinder Assembly

Cylinder model: CDJ2RA16-60Z-W-M9BW-B

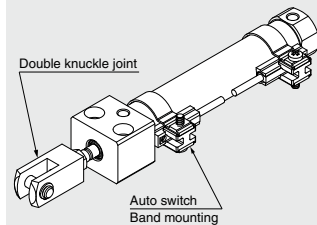

Mounting A: Bottom mounting
Rod end bracket W: Double knuckle joint
Auto switch D-M9BW: 2 pcs.
Auto switch mounting B: Band mounting

*: Double knuckle joint and auto switch are shipped together with the product, but not assembled.

Specifications

Bore size [mm]	10	16
Action	Double acting, Single rod	
Fluid	Air	
Proof pressure	1 MPa	
Maximum operating pressure	0.7 MPa	
Minimum operating pressure	0.06 MPa	
Ambient and fluid temperature	Without auto switch: -10°C to 70°C (No freezing) With auto switch: -10°C to 60°C	
Cushion	Rubber bumper	
Lubrication	Not required (Non-lube)	
Stroke length tolerance	+1.0 0	
Piston speed	50 to 750 mm/s	
Allowable kinetic energy	0.035 J	0.090 J

Standard Strokes

Bore size	Standard stroke [mm]	Maximum manufacturable stroke
10	15, 30, 45, 60, 75, 100, 125, 150	400
16	15, 30, 45, 60, 75, 100, 125, 150, 175, 200	400

*: Manufacture of intermediate strokes in 1 mm increments is possible. (Spacers are not used.)
*: Applicable strokes should be confirmed according to the usage. For details, refer to "Air Cylinders Model Selection" on pages 8 to 19. In addition, the products that exceed the standard stroke might not be able to fulfill the specifications due to the deflection etc.

Accessories

Refer to page 68 for the list of brackets and page 91 for details about part numbers and dimensions.

Standard	Rod end nut
Option ^{Note 1)}	Single knuckle joint, Double knuckle joint (including a pin and retaining rings), Rod end cap (Flat/Round type), Double knuckle joint (With one-touch connecting pin)

Note 1) Can be ordered within the cylinder model. Except for the double knuckle joint (with one-touch connecting pin).

Note 2) Stainless steel accessories are also available. Refer to page 92 for details.

Weights

Bore size [mm]	10	16	
Basic weight	Basic	36	61
	(When the stroke is zero) Axial piping	36	61
Additional weight per 15 mm of stroke		4	7
	Single knuckle joint	17	23
Accessories	Double knuckle joint (including knuckle pin)	25	21
	Double knuckle joint (With one-touch connecting pin)	26	22
	Rod end cap (Flat type)	1	2
	Rod end cap (Round type)	1	2

*: Mounting nut and rod end nut are included in the basic weight.

Calculation:

Example) **CJ2RA10-45Z**

- Basic weight 36 (ø10)
 - Additional weight 4/15 stroke
 - Cylinder stroke 45 stroke
- $36 + 4/15 \times 45 = 48 \text{ g}$

Refer to pages 172 to 179 for cylinders with auto switches.

- Auto switch proper mounting position (detection at stroke end) and its mounting height
- Minimum stroke for auto switch mounting
- Operating range
- Auto switch mounting brackets/Part no.

Clean Series

10-CJ2RA $\begin{matrix} 10 \\ 16 \end{matrix}$ - Stroke Head cover port location Z
 • Clean Series

Air cylinder which is applicable for the system which discharges leakage from the rod section directly into the outside of clean room by relief port and making an actuator's rod section having a double seal construction.

For the detailed specifications, refer to the **Web Catalog**.

Specifications

Action	Double acting, Single rod
Bore size [mm]	10, 16
Maximum operating pressure	0.7 MPa
Minimum operating pressure	0.08 MPa
Cushion	Rubber bumper
Standard stroke [mm]	Same as standard type. (Refer to page 150.)
Auto switch	Mountable (Band mounting)
Mounting	Bottom mounting

Construction (Not able to disassemble)

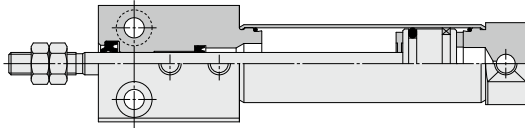

CJ2R Series

Construction (Not able to disassemble)

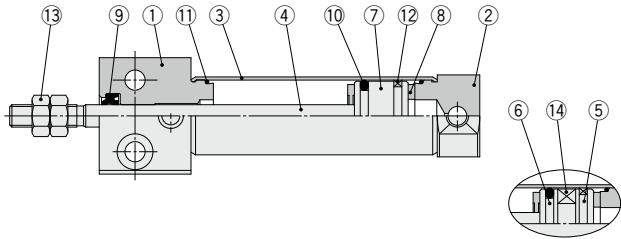

With auto switch

Component Parts

No.	Description	Material	Note
1	Rod cover	Aluminum alloy	
2	Head cover	Aluminum alloy	
3	Cylinder tube	Stainless steel	
4	Piston rod	Stainless steel	
5	Piston A	Aluminum alloy	
6	Piston B	Aluminum alloy	
7	Piston	Aluminum alloy	

No.	Description	Material	Note
8	Bumper	Urethane	
9	Rod seal	NBR	
10	Piston seal	NBR	
11	Tube gasket	NBR	
12	Wear ring	Resin	
13	Rod end nut	Rolled steel	
14	Magnet	—	

Bottom Mounting

CJ2RA $\frac{10}{16}$ - Stroke Head cover port location Z

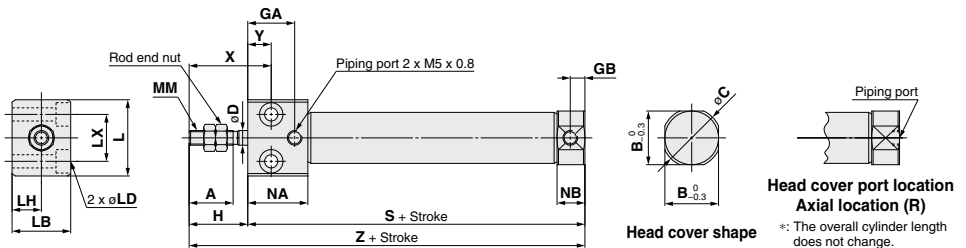

Head cover port location Axial location (R)

*: The overall cylinder length does not change.

Bore size	A	B	C	D	GA	GB	H	L	LB	LD	LH	LX	MM	NA	NB	X	Y	S	Z
10	15	12	14	4	16	5	20	23	16	ø3.5 through, ø6.5 counterbore depth 4	8	12	M4 x 0.7	20.5	9.5	28	8	54	74
16	15	18.3	20	5	16	5	20	26	20	ø4.5 through, ø8 counterbore depth 5	10	16	M5 x 0.8	20.5	9.5	28	8	55	75

[mm]

Air Cylinder: Direct Mount Type Single Acting, Spring Return/Extend

CJ2R Series

ø10, ø16

RoHS

How to Order

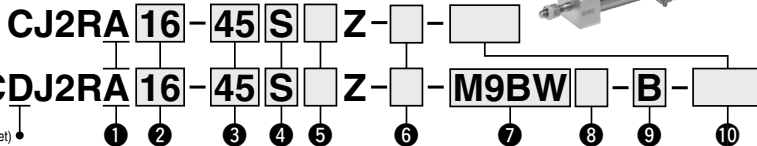
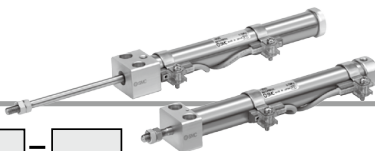

With auto switch

With auto switch (Built-in magnet)

1 Mounting

A	Bottom mounting
---	-----------------

2 Bore size

10	10 mm
16	16 mm

3 Cylinder standard stroke [mm]

Refer to "Standard Strokes" on page 154.

4 Action

S	Single acting, Spring return
T	Single acting, Spring extend

5 Head cover port location

Nil	Perpendicular to axis	
	Axial	

*: Not applicable to single acting, spring extend (T).

6 Rod end bracket

Nil	None
V	Single knuckle joint
W**	Double knuckle joint
T	Rod end cap (Flat type)
U	Rod end cap (Round type)

*: Rod end bracket is shipped together with the product, but not assembled.
**: Refer to page 91 for the double knuckle joint (with one-touch connecting pin).

7 Auto switch

Nil	Without auto switch
-----	---------------------

*: For applicable auto switches, refer to the table below.

★ Enter the auto switch mounting type (A or B) even when a built-in magnet cylinder without an auto switch is required.

8 Number of auto switches

Nil	2 pcs.
S	1 pc.
n	"n" pcs.

9 Auto switch mounting type

A	Rail mounting
B	Band mounting

*: For rail mounting, screws and nuts for 2 auto switches come with the rail.
*: Refer to page 178 for auto switch mounting brackets.

10 Made to Order

Refer to page 154 for details.

*: Refer to "Ordering Example of Cylinder Assembly" on page 154.

Applicable Auto Switches/Refer to pages 1271 to 1365 for further information on auto switches.

Type	Special function	Electrical entry	Indicator light	Wiring (Output)	Load voltage		Auto switch model				Lead wire length [m]					Pre-wired connector	Applicable load		
					DC	AC	Band mounting		Rail mounting		0.5 (Nil)	1 (M)	3 (L)	5 (Z)	None (N)				
							Perpendicular	In-line	Perpendicular	In-line									
Solid state auto switch	—	Grommet	No	3-wire (NPN)	5 V, 12 V	—	M9NV	M9N	M9NV	M9N	●	●	●	○	○	○	IC circuit		
				3-wire (PNP)			M9PV	M9P	M9PV	M9P	●	●	●	○	○				
		Connector	2-wire	M9BV			M9B	M9BV	M9B	●	●	●	○	○					
			—	—			H7C	J79C	—	—	—	—	—	—					
	Diagnostic indication (2-color indicator)	Grommet	Yes	3-wire (NPN)	5 V, 12 V	—	M9NWV	M9NW	M9NWV	M9NW	●	●	●	○	○	○		IC circuit	
				3-wire (PNP)			M9PWV	M9PW	M9PWV	M9PW	●	●	●	○	○				
		Connector	2-wire	M9BWV			M9BV	M9BWV	M9BV	●	●	●	○	○					
			—	—			—	—	—	—	—	—	—	—					
Water resistant (2-color indicator)	Grommet	No	3-wire (NPN)	5 V, 12 V	—	M9NAV*1	M9NA*1	M9NAV*1	M9NA*1	○	○	●	○	○	○	IC circuit			
			3-wire (PNP)			M9PAV*1	M9PA*1	M9PAV*1	M9PA*1	○	○	○	○	○					
	Connector	2-wire	M9BAV*1			M9BA*1	M9BAV*1	M9BA*1	○	○	○	○	○						
		—	—			—	—	—	—	—	—	—	—						
Reed auto switch	—	Grommet	Yes	3-wire (NPN equivalent)	5 V	—	A96V	A96	A96V	A96	●	—	●	—	—		IC circuit		
				—			—	—	—	—	—	—	—	—	—				
		Connector	No	2-wire			100 V	A93V*2	A93	A93V*2	A93	●	●	●	—			—	Relay, PLC
							100 V or less	A90V	A90	A90V	A90	●	●	●	—			—	
	Diagnostic indication (2-color indicator)	Grommet	Yes	2-wire	24 V	12 V	—	—	C73C	A73C	—	●	●	●	●	IC circuit			
							—	—	C80C	A80C	—	—	—	—	—				
		Connector	No	—			—	—	—	—	—	—	—	—	—			—	
				—			—	—	—	—	—	—	—	—	—				

*1: Water resistant type auto switches can be mounted on the above models, but in such case SMC cannot guarantee water resistance. Please contact SMC regarding water resistant types with the above model numbers.

*2: 1 m type lead wire is only applicable to D-A93.

*: Lead wire length symbols: 0.5 m..... Nil (Example) M9NV
1 m..... M (Example) M9NWM
3 m..... L (Example) M9NWL
5 m..... Z (Example) M9NWX
None..... N (Example) H7CN

*: Since there are other applicable auto switches than listed, refer to page 179 for details.

*: Solid state auto switches marked with "○" are produced upon receipt of order.

*: The D-A93/M9□/A7□/A8□/F7□/J7□ auto switches are shipped together, but not assembled. (For band mounting, only auto switch mounting brackets are assembled before being shipped.)

CJ2R Series

The CJ2R direct mount cylinder can be installed directly through the use of a square rod cover.



Symbol

Single acting, Spring return, Rubber bumper

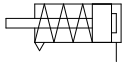

Single acting, Spring extend, Rubber bumper

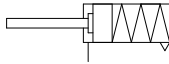

Made to Order: Individual Specifications
(For details, refer to page 180.)

Symbol	Specifications
-X446	PTFE grease

Made to Order

[Click here for details](#)

Symbol	Specifications
-XA□	Change of rod end shape
-XC51	With hose nipple
-XC85	Grease for food processing equipment



Precautions

Refer to page 183 before handling.

Ordering Example of Cylinder Assembly

Cylinder model: CDJ2RA16-45SZ-W-M9BW-B

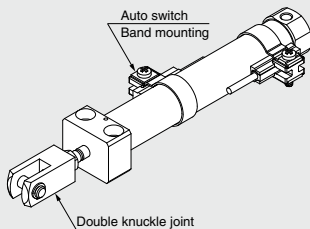

Mounting A: Bottom mounting
Rod end bracket W: Double knuckle joint
Auto switch D-M9BW: 2 pcs.
Auto switch mounting B: Band mounting

*: Double knuckle joint and auto switch are shipped together with the product, but not assembled.

Specifications

Bore size [mm]	10	16
Action	Single acting, Spring return/Single acting, Spring extend	
Fluid	Air	
Proof pressure	1 MPa	
Maximum operating pressure	0.7 MPa	
Minimum operating pressure	0.15 MPa	
Ambient and fluid temperature	Without auto switch: -10°C to 70°C With auto switch: -10°C to 60°C (No freezing)	
Cushion	Rubber bumper	
Lubrication	Not required (Non-lube)	
Stroke length tolerance	+1.0 0	
Piston speed	50 to 750 mm/s	
Allowable kinetic energy	0.035 J	0.090 J

Standard Strokes

Bore size	Standard stroke [mm]
10	15, 30, 45, 60
16	15, 30, 45, 60, 75, 100, 125, 150

*: Manufacture of intermediate strokes in 1 mm increments is possible. (Spacers are not used.)

*: Please consult with SMC for strokes which exceed the standard stroke length.

*: Applicable strokes should be confirmed according to the usage. For details, refer to "Air Cylinders Model Selection" on pages 8 to 19. In addition, the products that exceed the standard stroke might not be able to fulfill the specifications due to the deflection etc.

Accessories

Refer to page 68 for the list of brackets and page 91 for details about part numbers and dimensions.

Standard	Rod end nut
Option ^{Note 1)}	Single knuckle joint, Double knuckle joint (including a pin and retaining rings), Rod end cap (Flat type, Round type), Double knuckle joint (With one-touch connecting pin)

Note 1) Can be ordered within the cylinder model. Except for the double knuckle joint (with one-touch connecting pin).

Note 2) Stainless steel accessories are also available. Refer to page 92 for details.

Spring Reaction Force

Refer to page 1571 (Table (2): Spring Reaction Force).

Refer to pages 172 to 179 for cylinders with auto switches.

- Auto switch proper mounting position (detection at stroke end) and its mounting height
- Minimum stroke for auto switch mounting
- Operating range
- Auto switch mounting brackets/Part no.

Weights

Spring Return

Bore size [mm]		10		16	
Mounting		Basic	Axial piping	Basic	Axial piping
Basic weight	15 stroke	42	42	81	81
	30 stroke	49	49	97	97
	45 stroke	59	59	114	114
	60 stroke	68	68	132	132
	75 stroke			154	154
	100 stroke			187	187
	125 stroke			224	224
	150 stroke			246	246
Accessories	Single knuckle joint	17		23	
	Double knuckle joint (including knuckle pin)	25		21	
	Double knuckle joint (With one-touch connecting pin)	26		22	
	Rod end cap (Flat type)	1		2	
	Rod end cap (Round type)	1		2	

※: Rod end nut is included in the basic weight.

Spring Extend

Bore size [mm]		10		16	
Mounting		Basic	Basic	Basic	Basic
Basic weight	15 stroke	41		78	
	30 stroke	47		92	
	45 stroke	55		108	
	60 stroke	64		123	
	75 stroke			144	
	100 stroke			173	
	125 stroke			208	
	150 stroke			228	
Accessories	Single knuckle joint	17		23	
	Double knuckle joint (including knuckle pin)	25		21	
	Double knuckle joint (With one-touch connecting pin)	26		22	
	Rod end cap (Flat type)	1		2	
	Rod end cap (Round type)	1		2	

Construction (Not able to disassemble)

Single acting, Spring return

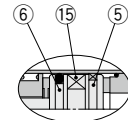
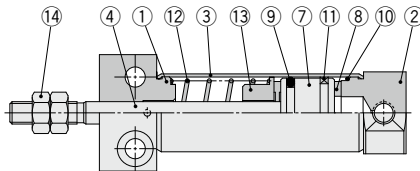

With auto switch

Single acting, Spring extend

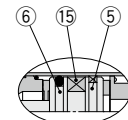
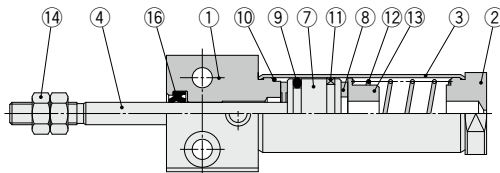

With auto switch

Component Parts

No.	Description	Material	Note
1	Rod cover	Aluminum alloy	
2	Head cover	Aluminum alloy	
3	Cylinder tube	Stainless steel	
4	Piston rod	Stainless steel	
5	Piston A	Aluminum alloy	
6	Piston B	Aluminum alloy	
7	Piston	Aluminum alloy	
8	Bumper	Urethane	

No.	Description	Material	Note
9	Piston seal	NBR	
10	Tube gasket	NBR	
11	Wear ring	Resin	
12	Return spring	Piano wire	
13	Spring seat	Aluminum alloy	
14	Rod end nut	Rolled steel	
15	Magnet	—	
16	Rod seal	NBR	

CJ2R Series

Single Acting: Bottom Mounting

Spring return: CJ2RA $\frac{10}{16}$ – Stroke S | Head cover port location Z

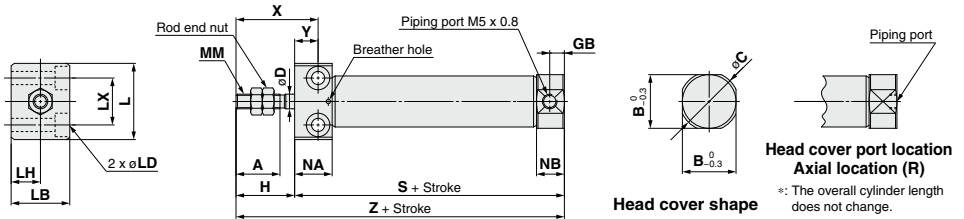

Bore size	A	B	C	D	GB	H	L	LB	LD	LH	LX	MM	NA	NB	X	Y
10	15	12	14	4	5	20	23	16	ø3.5 through, ø6.5 counterbore depth 4	8	12	M4 x 0.7	12.8	9.5	28	8
16	15	18.3	20	5	5	20	26	20	ø4.5 through, ø8 counterbore depth 5	10	16	M5 x 0.8	12.8	9.5	28	8

Dimensions by Stroke: Spring Return

Bore size	S								Z							
	5 to 15 st	16 to 30 st	31 to 45 st	46 to 60 st	61 to 75 st	76 to 100 st	101 to 125 st	126 to 150 st	5 to 15 st	16 to 30 st	31 to 45 st	46 to 60 st	61 to 75 st	76 to 100 st	101 to 125 st	126 to 150 st
10	53.5	61	73	85	—	—	—	—	73.5	81	93	105	—	—	—	—
16	53.5	62	74	86	92	116	134	146	73.5	82	94	106	112	136	154	166

Spring extend: CJ2RA $\frac{10}{16}$ – Stroke TZ

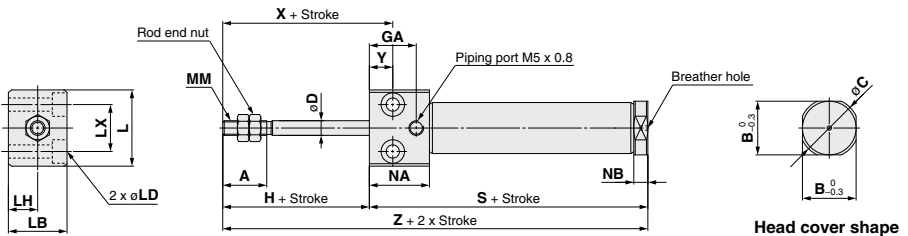

Bore size	A	B	C	D	GA	H	L	LB	LD	LH	LX	MM	NA	NB	X	Y
10	15	12	14	4	16	20	23	16	ø3.5 through, ø6.5 counterbore depth 4	8	12	M4 x 0.7	20.5	4.8	28	8
16	15	18.3	20	5	16	20	26	20	ø4.5 through, ø8 counterbore depth 5	10	16	M5 x 0.8	20.5	4.8	28	8

Dimensions by Stroke: Spring Extend

Bore size	S								Z							
	5 to 15 st	16 to 30 st	31 to 45 st	46 to 60 st	61 to 75 st	76 to 100 st	101 to 125 st	126 to 150 st	5 to 15 st	16 to 30 st	31 to 45 st	46 to 60 st	61 to 75 st	76 to 100 st	101 to 125 st	126 to 150 st
10	56.5	64	76	88	—	—	—	—	76.5	84	96	108	—	—	—	—
16	56.5	65	77	89	95	119	137	149	76.5	85	97	109	115	139	157	169

Air Cylinder: Direct Mount, Non-rotating Rod Type Double Acting, Single Rod

CJ2RK Series

ø10, ø16



How to Order

CJ2RKA 16 - 60 □ Z - □ - □

With auto switch

CDJ2RKA 16 - 60 □ Z - □ - M9BW □ - B - □

With auto switch (Built-in magnet)*

1 Mounting

A	Bottom mounting
---	-----------------

2 Bore size

10	10 mm
16	16 mm

3 Cylinder standard stroke [mm]

Refer to "Standard Strokes" on page 158.

4 Head cover port location

Nil	Perpendicular to axis	
R	Axial	

5 Rod end bracket

Nil	None
V	Single knuckle joint
W**	Double knuckle joint
T	Rod end cap (Flat type)
U	Rod end cap (Round type)

*: Rod end bracket is shipped together with the product, but not assembled.
**: Refer to page 91 for the double knuckle joint (with one-touch connecting pin).

6 Auto switch

Nil	Without auto switch
-----	---------------------

*: For applicable auto switches, refer to the table below.
* Enter the auto switch mounting type (A or B) even when a built-in magnet cylinder without an auto switch is required.

7 Number of auto switches

Nil	2 pcs.
S	1 pc.
n	"n" pcs.

8 Auto switch mounting type

A	Rail mounting
B	Band mounting

*: For rail mounting, screws and nuts for 2 auto switches come with the rail.
*: Refer to page 178 for auto switch mounting brackets.

9 Made to Order

Refer to page 158 for details.

*: Refer to "Ordering Example of Cylinder Assembly" on page 158.

Applicable Auto Switches/Refer to pages 1271 to 1365 for further information on auto switches.

Type	Special function	Electrical entry	Indicating light	Wiring (Output)	Load voltage		Auto switch model				Pre-wired connector	Applicable load					
					DC	AC	Band mounting		Rail mounting				0.5 (Nil)	1 (M)	3 (L)	5 (Z)	None (N)
							Perpendicular	In-line	Perpendicular	In-line							
Solid state auto switch	—	Grommet	No	3-wire (NPN)	5 V, 12 V	—	M9NV	M9N	M9NV	M9N	●	●	○	○	IC circuit		
				3-wire (PNP)			M9PV	M9P	M9PV	M9P	●	●	○	○			
		Connector	2-wire	M9BV	M9B	M9BV	M9B	●	●	○	○						
			—	H7C	J79C	—	—	●	●	○	○						
	Diagnostic indication (2-color indicator)	Grommet	Yes	3-wire (NPN)	5 V, 12 V	—	M9NWV	M9NW	M9NWV	M9NW	●	●	○	○	IC circuit		
				3-wire (PNP)			M9PWW	M9PW	M9PWW	M9PW	●	●	○	○			
	Water resistant (2-color indicator)	Grommet	No	2-wire	12 V	—	M9BWW	M9BW	M9BWW	M9BW	●	●	○	○	—		
				3-wire (NPN)			M9NAV* ¹	M9NA* ¹	M9NAV* ¹	M9NA* ¹	○	○	○	○			
	With diagnostic output (2-color indicator)	Grommet	No	3-wire (PNP)	5 V, 12 V	—	M9PAV* ¹	M9PA* ¹	M9PAV* ¹	M9PA* ¹	○	○	○	○	IC circuit		
				2-wire			M9BAV* ¹	M9BA* ¹	M9BAV* ¹	M9BA* ¹	○	○	○	○			
Reed auto switch	—	Grommet	Yes	3-wire (NPN equivalent)	5 V	—	A96V	A96	A96V	A96	●	—	●	—	IC circuit		
				—			—	—	—	—	—	—	—	—			
		Connector	No	2-wire	200 V	—	—	A72	A72H	—	—	●	—	●	—	—	
					100 V	A93V* ²	A93	A93V* ²	A93	●	●	●	●				
	Grommet	Yes	2-wire	12 V	100 V or less	A90V	A90	A90V	A90	●	—	●	—	IC circuit			
				24 V or less	—	C73C	A73C	—	—	●	—	●	—				
	Diagnostic indication (2-color indicator)	Grommet	Yes	2-wire	24 V or less	—	C80C	A80C	—	—	●	—	●	—	IC circuit		
							—	—	A79W	—	—	—	●	—		●	—

*1: Water resistant type auto switches can be mounted on the above models, but in such case SMC cannot guarantee water resistance. Please contact SMC regarding water resistant types with the above model numbers.

*2: 1 m type lead wire is only applicable to D-A93.

*: Lead wire length symbols: 0.5 m..... Nil (Example) M9NW
1 m..... M (Example) M9NWM
3 m..... L (Example) M9NWL
5 m..... Z (Example) M9NZZ
None..... N (Example) H7CN

*: Since there are other applicable auto switches than listed, refer to page 179 for details.

*: Solid state auto switches marked with "○" are produced upon receipt of order.

*: The D-A9□/M9□/A7□/A8□/F7□/J7□ auto switches are shipped together, but not assembled. (For band mounting, only auto switch mounting brackets are assembled before being shipped.)



CJ2RK Series

A cylinder which rod does not rotate because of the hexagonal rod shape.

Non-rotating accuracy

ø10: ±1.5°, ø16: ±1°

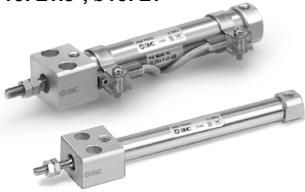

Symbol

Double acting, Single rod, Rubber bumper

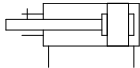

Made to Order: Individual Specifications
(For details, refer to page 180.)

Symbol	Specifications
-X446	PTFE grease

Made to Order

[Click here for details](#)

Symbol	Specifications
-XA □	Change of rod end shape
-XC9	Adjustable stroke cylinder/Adjustable retraction type
-XC51	With hose nipple
-XC85	Grease for food processing equipment

⚠ Precautions

Refer to page 183 before handling.

Ordering Example of Cylinder Assembly

Cylinder model: **CDJ2RKA16-60Z-W-M9BW-B**

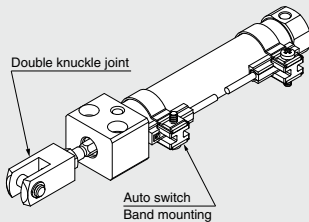

Mounting A: Bottom mounting
Rod end bracket W: Double knuckle joint
Auto switch D-M9BW: 2 pcs.
Auto switch mounting B: Band mounting

*: Double knuckle joint and auto switch are shipped together with the product, but not assembled.

Specifications

Bore size [mm]	10	16
Action	Double acting, Single rod	
Fluid	Air	
Proof pressure	1 MPa	
Maximum operating pressure	0.7 MPa	
Minimum operating pressure	0.06 MPa	
Ambient and fluid temperature	Without auto switch: -10°C to 70°C (No freezing) With auto switch: -10°C to 60°C	
Cushion	Rubber bumper	
Lubrication	Not required (Non-lube)	
Stroke length tolerance	+1.0 0	
Rod non-rotating accuracy	±1.5°	±1°
Piston speed	50 to 750 mm/s	
Allowable kinetic energy	0.035 J	0.090 J

Standard Strokes

Bore size	Standard stroke [mm]
10	15, 30, 45, 60, 75, 100, 125, 150
16	15, 30, 45, 60, 75, 100, 125, 150, 175, 200

- *: Manufacture of intermediate strokes in 1 mm increments is possible. (Spacers are not used.)
- *: Please consult with SMC for strokes which exceed the standard stroke length.
- *: Applicable strokes should be confirmed according to the usage. For details, refer to "Air Cylinders Model Selection" on pages 8 to 19. In addition, the products that exceed the standard stroke might not be able to fulfill the specifications due to the deflection etc.

Accessories

(Refer to page 68 for the list of brackets and page 91 for details about part numbers and dimensions.)

Standard	Rod end nut
Option ^{Note 1}	Single knuckle joint, Double knuckle joint (including a pin and retaining rings), Rod end cap (Flat/Round type), Double knuckle joint (With one-touch connecting pin)

Note 1) Can be ordered within the cylinder model. Except for the double knuckle joint (with one-touch connecting pin).

Note 2) Stainless steel accessories are also available. Refer to page 92 for details.

Weights

Bore size [mm]		10	16
Basic weight	Basic	36	62
	(When the stroke is zero) Axial piping	36	62
Additional weight per 15 mm of stroke		4	7
Accessories	Single knuckle joint	17	23
	Double knuckle joint (including knuckle pin)	25	21
	Double knuckle joint (With one-touch connecting pin)	26	22
	Rod end cap (Flat type)	1	2
	Rod end cap (Round type)	1	2

*: Rod end nut is included in the basic weight.

Calculation:

Example) **CJ2RKA10-45Z**

- Basic weight 36 (ø10)
 - Additional weight 4/15 stroke
 - Cylinder stroke 45 stroke
- 36 + 4/15 x 45 = **48 g**

Refer to pages 172 to 179 for cylinders with auto switches.

- Auto switch proper mounting position (detection at stroke end) and its mounting height
- Minimum stroke for auto switch mounting
- Operating range
- Auto switch mounting brackets/Part no.

Construction (Not able to disassemble)

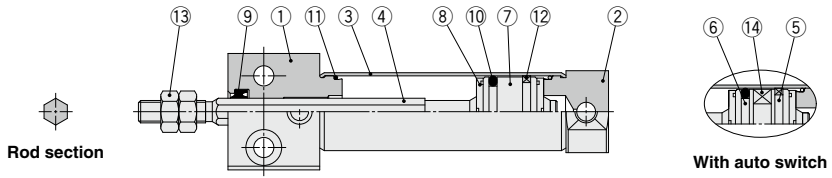

Component Parts

No.	Description	Material	Note
1	Rod cover	Aluminum alloy	
2	Head cover	Aluminum alloy	
3	Cylinder tube	Stainless steel	
4	Piston rod	Stainless steel	
5	Piston A	Aluminum alloy	
6	Piston B	Aluminum alloy	
7	Piston	Aluminum alloy	

No.	Description	Material	Note
8	Bumper	Urethane	
9	Rod seal	NBR	
10	Piston seal	NBR	
11	Tube gasket	NBR	
12	Wear ring	Resin	
13	Rod end nut	Rolled steel	
14	Magnet	—	

Bottom Mounting

CJ2RKA $\frac{10}{16}$ - Stroke Head cover port location Z

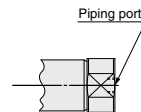
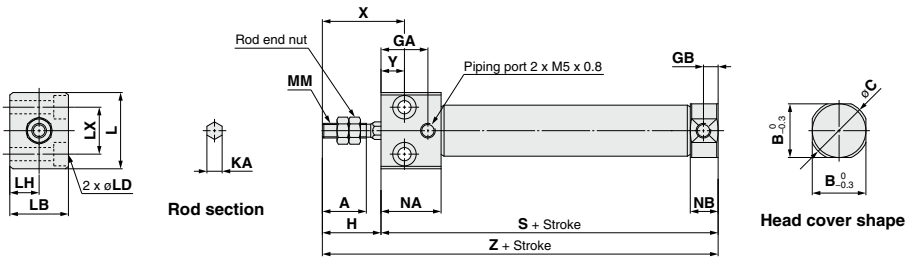

Head cover port location
Axial location (R)

*: The overall cylinder length does not change.

Bore size	A	B	C	GA	GB	H	KA	L	LB	LD	LH	LX	MM	NA	NB	X	Y	S	Z
10	15	12	14	16	5	20	4.2	23	16	ø3.5 through, ø6.5 counterbore depth 4	8	12	M4 x 0.7	20.5	9.5	28	8	54	74
16	15	18.3	20	16	5	20	5.2	26	20	ø4.5 through, ø8 counterbore depth 5	10	16	M5 x 0.8	20.5	9.5	28	8	55	75

[mm]

Air Cylinder: Direct Mount, Non-rotating Rod Type Single Acting, Spring Return/Extend

CJ2RK Series



ø10, ø16

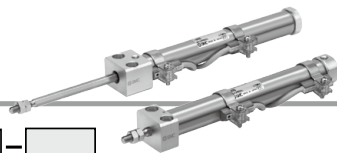

How to Order

CJ2RKA 16-45 S □ Z-□-□

With auto switch

CDJ2RKA 16-45 S □ Z-□-M9BW □ -B-□

With auto switch (Built-in magnet)*

1 Mounting

A	Bottom mounting
---	-----------------

2 Bore size

10	10 mm
16	16 mm

3 Cylinder standard stroke [mm]

Refer to "Standard Strokes" on page 161.

4 Action

S	Single acting, Spring return
T	Single acting, Spring extend

5 Head cover port location

Nil	Perpendicular to axis	
	Axial	

*: Not applicable to single acting, spring extend (T).

6 Rod end bracket

Nil	None
V	Single knuckle joint
W**	Double knuckle joint
T	Rod end cap (Flat type)
U	Rod end cap (Round type)

*: Rod end bracket is shipped together with the product, but not assembled.
**: Refer to page 91 for the double knuckle joint (with one-touch connecting pin).

7 Auto switch

Nil	Without auto switch
-----	---------------------

*: For applicable auto switches, refer to the table below.

★ Enter the auto switch mounting type (A or B) even when a built-in magnet cylinder without an auto switch is required.

8 Number of auto switches

Nil	2 pcs.
S	1 pc.
n	"n" pcs.

9 Auto switch mounting type

A	Rail mounting
B	Band mounting

*: For rail mounting, screws and nuts for 2 auto switches come with the rail.
*: Refer to page 178 for auto switch mounting brackets.

10 Made to Order

Refer to page 161 for details.

*: Refer to "Ordering Example of Cylinder Assembly" on page 161.

Applicable Auto Switches/Refer to pages 1271 to 1365 for further information on auto switches.

Type	Special function	Electrical entry	Indication light	Wiring (Output)	Load voltage		Auto switch model				Lead wire length [m]					Pre-wired connector	Applicable load
					DC	AC	Band mounting		Rail mounting		0.5 (Nil)	1 (M)	3 (L)	5 (Z)	None (N)		
							Perpendicular	In-line	Perpendicular	In-line							
Solid state auto switch	—	Grommet	No	3-wire (NPN)	5 V, 12 V	—	M9NV	M9N	M9N	M9N	●	●	○	—	○	C circuit	Relay, PLC
				3-wire (PNP)			M9PV	M9P	M9PV	M9P	●	●	○	—	○		
		Connector	2-wire	12 V	—	H7C	—	—	—	—	—	—	—	—			
		Diagnostic indication (2-color indicator)	Yes	3-wire (NPN)	5 V, 12 V	—	M9NWV	M9NW	M9NVV	M9NW	●	●	○	—	○		
	3-wire (PNP)			M9PWV			M9PW	M9PVV	M9PW	●	●	○	—	○			
	Grommet		No	2-wire	12 V	—	M9BWW	M9BW	M9BWW	M9BW	●	●	○	—	○		
				3-wire (NPN)	5 V, 12 V	—	M9NAV ^{*1}	M9NA ^{*1}	M9NAV ^{*1}	M9NA ^{*1}	○	○	●	○	○		
	3-wire (PNP)	M9PAV ^{*1}	M9PA ^{*1}	M9PAV ^{*1}			M9PA ^{*1}	○	○	●	○	○					
With diagnostic output (2-color indicator)	No	Grommet	No	2-wire	12 V	—	M9BAV ^{*1}	M9BA ^{*1}	M9BAV ^{*1}	M9BA ^{*1}	○	○	○	○	C circuit		
				4-wire (NPN)	5 V, 12 V	—	H7NF	—	F79W	—	—	—	—	—			
	Yes	Grommet	Yes	3-wire (NPN equivalent)	—	5 V	—	A96V	A96	A96V	A96	●	—	●	—	—	C circuit
								—	200 V	—	A72	A72H	●	—	●	—	
Reed auto switch	—	Grommet	No	2-wire	24 V	12 V	100 V or less	A93V ^{*2}	A93	A93V ^{*2}	A93	●	●	●	—	—	
							—	A90V	A90	A90V	A90	●	—	●	—	—	C circuit
							—	—	C73C	A73C	—	—	—	—	—	—	
							—	24 V or less	—	C80C	A80C	—	—	—	—	—	—
Diagnostic indication (2-color indicator)	Yes	Grommet	Yes	—	—	—	—	—	A79W	—	—	—	—	—	—		

*1: Water resistant type auto switches can be mounted on the above models, but in such case SMC cannot guarantee water resistance.

Please contact SMC regarding water resistant types with the above model numbers.

*2: 1 m type lead wire is only applicable to D-A53.

*: Lead wire length symbols: 0.5 m..... Nil (Example) M9NW
1 m..... M (Example) M9NWM
3 m..... L (Example) M9NWL
5 m..... Z (Example) M9NWX
None..... N (Example) H7CN

*: Since there are other applicable auto switches than listed, refer to page 179 for details.

*: Solid state auto switches marked with "○" are produced upon receipt of order.

*: The D-A9□/M9□/A7□/A8□/F7□/□/□ auto switches are shipped together, but not assembled. (For band mounting, only auto switch mounting brackets are assembled before being shipped.)

A cylinder which rod does not rotate because of the hexagonal rod shape.

Non-rotating accuracy
 $\phi 10: \pm 1.5^\circ$, $\phi 16: \pm 1^\circ$
Can operate without lubrication.



Symbol

Single acting, Spring return, Rubber bumper Single acting, Spring extend, Rubber bumper

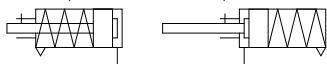

Made to Order: Individual Specifications
 (For details, refer to page 180.)

Symbol	Specifications
-XA46	PTFE grease

Made to Order

[Click here for details](#)

Symbol	Specifications
-XA	Change of rod end shape
-XC51	With hose nipple
-XC85	Grease for food processing equipment

⚠ Precautions

Refer to page 183 before handling.

Ordering Example of Cylinder Assembly

Cylinder model: CDJ2RKA16-45SZ-W-M9BW-B

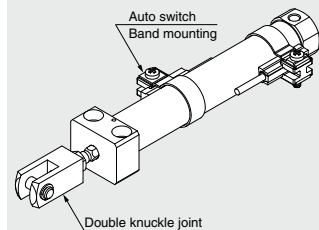

Mounting A: Bottom mounting
Rod end bracket W: Double knuckle joint
Auto switch D-M9BW: 2 pcs.
Auto switch mounting B: Band mounting

*: Double knuckle joint and auto switch are shipped together with the product, but not assembled.

Specifications

Bore size [mm]	10	16
Action	Single acting, Spring return/Single acting, Spring extend	
Fluid	Air	
Proof pressure	1 MPa	
Maximum operating pressure	0.7 MPa	
Minimum operating pressure	0.15 MPa	
Ambient and fluid temperature	Without auto switch: -10°C to 70°C (No freezing) With auto switch: -10°C to 60°C	
Cushion	Rubber bumper	
Lubrication	Not required (Non-lube)	
Stroke length tolerance	$^{+1.0}_0$	
Rod non-rotating accuracy	$\pm 1.5^\circ$	$\pm 1^\circ$
Piston speed	50 to 750 mm/s	
Allowable kinetic energy	0.035 J	0.090 J

Standard Strokes

Bore size	Standard stroke [mm]
10	15, 30, 45, 60
16	15, 30, 45, 60, 75, 100, 125, 150

*: Manufacture of intermediate strokes in 1 mm increments is possible. (Spacers are not used.)

*: Please consult with SMC for strokes which exceed the standard stroke length.

*: Applicable strokes should be confirmed according to the usage. For details, refer to "Air Cylinders Model Selection" on pages 8 to 19. In addition, the products that exceed the standard stroke might not be able to fulfill the specifications due to the deflection etc.

Accessories

Refer to page 68 for the list of brackets and page 91 for details about part numbers and dimensions.

Standard	Rod end nut
Option ^{Note 1)}	Single knuckle joint, Double knuckle joint (including a pin and retaining rings), Rod end cap (Flat/Round type), Double knuckle joint (With one-touch connecting pin)

Note 1) Can be ordered within the cylinder model. Except for the double knuckle joint (with one-touch connecting pin).

Note 2) Stainless steel accessories are also available. Refer to page 92 for details.

Spring Reaction Force

Bore size [mm]	Spring reaction force [N]	
	Primary	Secondary
10	3.53	6.86
16	6.86	14.2

Spring with primary mounting load

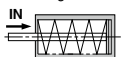

When the spring is set in the cylinder

Spring with secondary mounting load

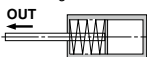

When the spring is contracted by applying air

Refer to pages 172 to 179 for cylinders with auto switches.

- Auto switch proper mounting position (detection at stroke end) and its mounting height
- Minimum stroke for auto switch mounting
- Operating range
- Auto switch mounting brackets/Part no.

CJ2RK Series

Weights

Spring Return

[g]

Bore size [mm]		10		16	
Basic weight	Mounting	Basic	Axial piping	Basic	Axial piping
		15 stroke	44	44	83
	30 stroke	52	52	99	99
	45 stroke	62	62	117	117
	60 stroke	72	72	135	135
	75 stroke			157	157
	100 stroke			191	191
	125 stroke			228	228
	150 stroke			251	251
Accessories	Single knuckle joint	17		23	
	Double knuckle joint (including knuckle pin)	25		21	
	Double knuckle joint (With one-touch connecting pin)	26		22	
	Rod end cap (Flat type)	1		2	
	Rod end cap (Round type)	1		2	

※: Rod end nut is included in the basic weight.

Spring Extend

[g]

Bore size [mm]		10		16	
Basic weight	Mounting	Basic	Basic	Basic	Basic
		15 stroke	42	42	79
	30 stroke	48	48	93	93
	45 stroke	57	57	110	110
	60 stroke	66	66	126	126
	75 stroke			147	147
	100 stroke			177	177
	125 stroke			213	213
	150 stroke			234	234
Accessories	Single knuckle joint	17		23	
	Double knuckle joint (including knuckle pin)	25		21	
	Double knuckle joint (With one-touch connecting pin)	26		22	
	Rod end cap (Flat type)	1		2	
	Rod end cap (Round type)	1		2	

Construction (Not able to disassemble)

Single acting, Spring return

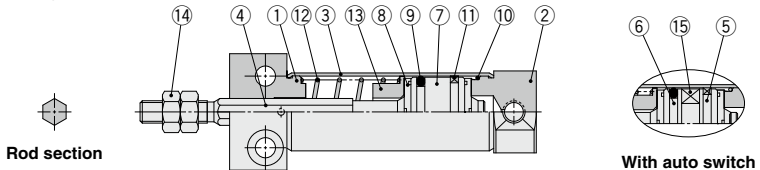

Single acting, Spring extend

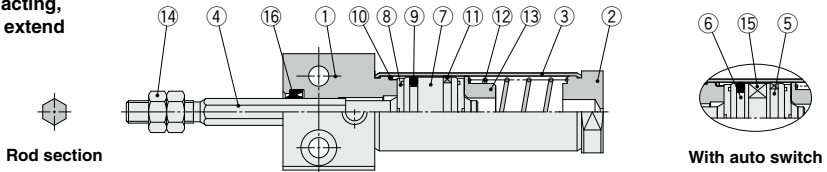

Component Parts

No.	Description	Material	Note
1	Rod cover	Aluminum alloy	
2	Head cover	Aluminum alloy	
3	Cylinder tube	Stainless steel	
4	Piston rod	Stainless steel	
5	Piston A	Aluminum alloy	
6	Piston B	Aluminum alloy	
7	Piston	Aluminum alloy	
8	Bumper	Urethane	

No.	Description	Material	Note
9	Piston seal	NBR	
10	Tube gasket	NBR	
11	Wear ring	Resin	
12	Return spring	Piano wire	
13	Spring seat	Aluminum alloy	
14	Rod end nut	Rolled steel	
15	Magnet	—	
16	Rod seal	NBR	

Single Acting: Bottom Mounting

Spring return: CJ2RK $\frac{10}{16}$ – Stroke S Head cover port location Z

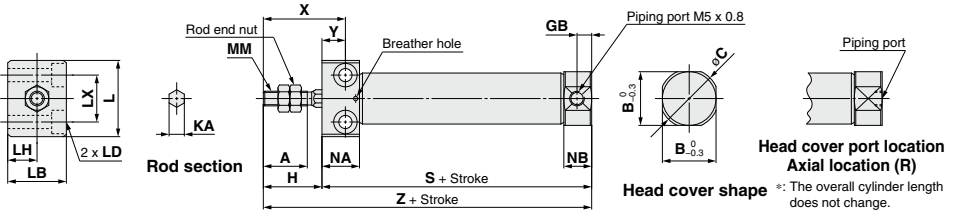

Bore size	[mm]															
	A	B	C	GB	H	KA	L	LB	LD	LH	LX	MM	NA	NB	X	Y
10	15	12	14	5	20	4.2	23	16	ø3.5 through, ø6.5 counterbore depth 4	8	12	M4 x 0.7	12.8	9.5	28	8
16	15	18.3	20	5	20	5.2	26	20	ø4.5 through, ø8 counterbore depth 5	10	16	M5 x 0.8	12.8	9.5	28	8

Dimensions by Stroke: Spring Return

Bore size	S														Z						[mm]
	5 to 15	16 to 30	31 to 45	46 to 60	61 to 75	76 to 100	101 to 125	126 to 150	5 to 15	16 to 30	31 to 45	46 to 60	61 to 75	76 to 100	101 to 125	126 to 150					
10	53.5	61	73	85	—	—	—	—	73.5	81	93	105	—	—	—	—					
16	53.5	62	74	86	92	116	134	146	73.5	82	94	106	112	136	154	166					

Spring extend: CJ2RK $\frac{10}{16}$ – Stroke TZ

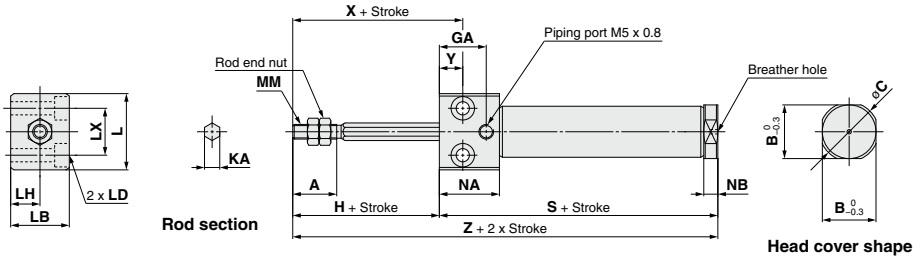

Bore size	[mm]															
	A	B	C	GA	H	KA	L	LB	LD	LH	LX	MM	NA	NB	X	Y
10	15	12	14	16	20	4.2	23	16	ø3.5 through, ø6.5 counterbore depth 4	8	12	M4 x 0.7	20.5	4.8	28	8
16	15	18.3	20	16	20	5.2	26	20	ø4.5 through, ø8 counterbore depth 5	10	16	M5 x 0.8	20.5	4.8	28	8

Dimensions by Stroke: Spring Extend (Dimensions not mentioned in the below table are the same as the above table.) [mm]

Bore size	S														Z					
	5 to 15	16 to 30	31 to 45	46 to 60	61 to 75	76 to 100	101 to 125	126 to 150	5 to 15	16 to 30	31 to 45	46 to 60	61 to 75	76 to 100	101 to 125	126 to 150				
10	56.5	64	76	88	—	—	—	—	76.5	84	96	108	—	—	—	—				
16	56.5	65	77	89	95	119	137	149	76.5	85	97	109	115	139	157	169				

Air Cylinder: With End Lock

CBJ2 Series

ø16



How to Order

With auto switch

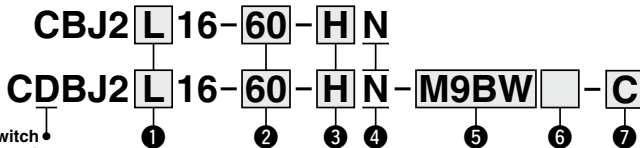

With auto switch
(Built-in magnet)

1 Mounting

B	Basic
L	Axial foot
F	Rod flange
D	Double clevis**

*: Foot/Flange brackets are shipped together with the product, but not assembled.

**: Rod end lock only.

2 Cylinder standard stroke [mm]

Refer to "Standard Strokes" on page 165.

3 Lock position

H	Head end lock
R	Rod end lock

4 Manual release

N	Non-locking type
---	------------------

5 Auto switch

Nil	Without auto switch
-----	---------------------

*: For applicable auto switches, refer to the table below.

★ Enter the auto switch mounting type (A or B) even when a built-in magnet cylinder without an auto switch is required.

6 Number of auto switches

Nil	2 pcs.
S	1 pc.
n	"n" pcs.

7 Auto switch mounting bracket

*: This symbol is indicated when the D-A9□ or M9□ type auto switch is specified. This mounting bracket does not apply to other auto switches (D-C7□ and H7□, etc.) (Nil)

Built-in Magnet Cylinder Model

Suffix the symbol "A" (Rail mounting) or "B" (Band mounting) to the end of part number for cylinder with auto switch.

Example	Rail mounting	CDBJ2B16-45-HN-A
	Band mounting	CDBJ2B16-60-HN-B

*: For rail mounting, screws and nuts for 2 auto switches come with the rail.

*: Refer to page 178 for auto switch mounting brackets.

Applicable Auto Switches/Refer to pages 1271 to 1365 for further information on auto switches.

Type	Special function	Electrical entry	Indicator light	Wiring (Output)	Load voltage		Auto switch model				Lead wire length [m]				Pre-wired connector	Applicable load	
					DC	AC	Band mounting		Rail mounting		0.5 (M)	1 (L)	3 (Z)	5 (N)			None (N)
							Perpendicular	In-line	Perpendicular	In-line							
Solid state auto switch	—	Grommet	No	3-wire (NPN)	5 V, 12 V	—	M9NV	M9N	M9NV	M9N	●	●	○	—	○	IC circuit	
				3-wire (PNP)			M9PV	M9P	M9PV	M9P	●	●	○	—	○		
		Connector	2-wire	M9BV			M9B	M9BV	M9B	●	●	○	—	○	—		
			—	—			H7C	J79C	—	—	—	—	—	—			
	Diagnostic indication (2-color indicator)	Grommet	Yes	3-wire (NPN)	5 V, 12 V	—	M9NWX	M9NW	M9NWX	M9NW	●	●	○	—	○	IC circuit	
				3-wire (PNP)			M9PWX	M9PW	M9PWX	M9PW	●	●	○	—	○		
		Connector	2-wire	M9BWX			M9BW	M9BWX	M9BW	●	●	○	—	○	—		
			—	—			—	—	—	—	—	—	—	—			
	Water resistant (2-color indicator)	Grommet	No	3-wire (NPN)	5 V, 12 V	—	M9NAV ^{*1}	M9NA ^{*1}	M9NAV ^{*1}	M9NA ^{*1}	○	○	●	—	○	IC circuit	
				3-wire (PNP)			M9PAV ^{*1}	M9PA ^{*1}	M9PAV ^{*1}	M9PA ^{*1}	○	○	●	—	○		
Connector		2-wire	M9BAV ^{*1}	M9BA ^{*1}			M9BAV ^{*1}	M9BA ^{*1}	○	○	●	—	○	—			
		4-wire (NPN)	—	H7NF			—	F79F	●	—	●	—	—		○		
Reed auto switch	—	Grommet	Yes	3-wire (NPN equivalent)	5 V	—	A96V	A96	A96V	A96	●	—	●	—	—	IC circuit	
				—			—	A72	A72H	●	—	●	—	—			
		Connector	2-wire	100 V			A93V ^{*2}	A93	A93V ^{*2}	A93	●	●	●	—	—		—
			—	100 V or less			A90V	A90	A90V	A90	●	●	●	—	—		
	Diagnostic indication (2-color indicator)	Grommet	Yes	2-wire	24 V	12 V	—	C73C	A73C	—	—	●	—	●	—	IC circuit	
				—			24 V or less	C80C	A80C	—	—	●	—	●	—		
—	—	—	—	—	—	—	A79W	—	—	—	●	—	●	—	—		

*1: Water resistant type auto switches can be mounted on the above models, but in such case SMC cannot guarantee water resistance. Please contact SMC regarding water resistant types with the above model numbers.

*2: 1 m type lead wire is only applicable to D-A93.

*: Lead wire length symbols: 0.5 m..... Nil (Example) M9NW
 1 m..... M (Example) M9NWM
 3 m..... L (Example) M9NWL
 5 m..... Z (Example) M9NWZ
 None..... N (Example) H7CN

*: Since there are other applicable auto switches than listed, refer to page 179 for details.

*: Solid state auto switches marked with "○" are produced upon receipt of order.

*: The D-A9□/M9□/A7□/A8□/F7□/J7□ auto switches are shipped together, (but not assembled). (However, when the D-A9□/M9□ types are selected, only auto switch mounting brackets are assembled before being shipped.)

*: When the D-A9□/M9□ types are mounted on a rail, order auto switch mounting brackets separately. Refer to page 178 for details.

The CJ2 air cylinder is equipped with end lock function.



Symbol

Rubber bumper

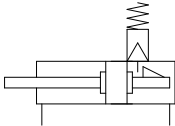

Specifications

Bore size [mm]	16
Action	Double acting, Single rod
Fluid	Air
Proof pressure	1 MPa
Maximum operating pressure	0.7 MPa
Minimum operating pressure	0.15 MPa*
Ambient and fluid temperature	Without auto switch: -10°C to 70°C (No freezing) With auto switch: -10°C to 60°C
Cushion	Rubber bumper
Lubrication	Not required (Non-lube)
Stroke length tolerance	+1.0 0
Piston speed	50 to 750 mm/s
Allowable kinetic energy	0.090 J

*: 0.06 MPa for parts other than the lock unit.

Lock Specifications

Lock position	Head end, Rod end
Holding force (Max.)	98 N
Lock release pressure	0.15 MPa or less
Backlash	1 mm or less
Manual release	Non-locking type

Standard Strokes

Bore size	Standard stroke
16	15, 30, 45, 60, 75, 100, 125, 150, 175, 200

[mm]

*: Manufacture of intermediate strokes in 1 mm increments is possible. (Spacers are not used.)
*: Applicable strokes should be confirmed according to the usage. For details, refer to "Air Cylinders Model Selection" on pages 8 to 19. In addition, the products that exceed the standard stroke might not be able to fulfill the specifications due to the deflection etc.

Mounting Brackets/Part No.

Mounting bracket	Bore size [mm]
	16
Foot	CJ-L016C
Flange	CJ-F016C
Pivot bracket (T-bracket) ^{Note 1)}	CJ-T016C

Note 1) The pivot bracket (T-bracket) is used with double clevis (D).

Note 2) Stainless steel mounting brackets and accessories are also available.

Refer to page 92 for details.

Refer to pages 172 to 179 for cylinders with auto switches.

- Auto switch proper mounting position (detection at stroke end) and its mounting height
- Minimum stroke for auto switch mounting
- Operating range
- Auto switch mounting brackets/Part no.

Moisture Control Tube IDK Series



When operating an actuator with a small diameter and a short stroke at a high frequency, the dew condensation (water droplet) may occur inside the piping depending on the conditions.

Simply connecting the moisture control tube to the actuator will prevent dew condensation from occurring. For details, refer to the [Web Catalog](#).

CBJ2 Series

Construction (Not able to disassemble)

Head end lock

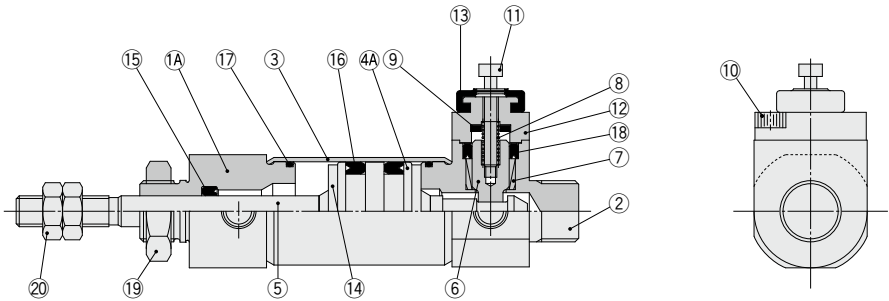

Rod end lock

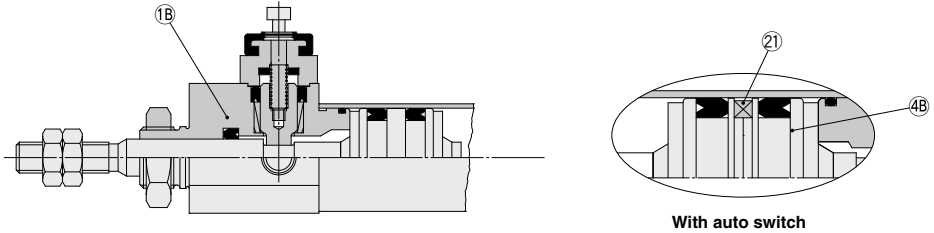

Component Parts

No.	Description	Material	Note
1A	Rod cover	Aluminum alloy	
1B	Rod cover	Stainless steel	
2	Head cover	Aluminum alloy	
3	Cylinder tube	Stainless steel	
4A	Piston	Aluminum alloy	
4B	Piston B	Aluminum alloy	
5	Piston rod	Carbon steel	
6	Locking piston	Carbon steel	
7	Locking bushing	Copper alloy	
8	Lock spring	Spring steel	
9	Bumper	Urethane	
10	Hexagon socket head cap screw	Alloy steel	

No.	Description	Material	Note
11	Hexagon socket head cap screw	Alloy steel	
12	Cap	Aluminum alloy	
13	Rubber cap	Synthetic rubber	
14	Bumper	Urethane	
15	Rod seal	NBR	
16	Piston seal	NBR	
17	Tube gasket	NBR	
18	Locking piston seal	NBR	
19	Mounting nut	Brass	
20	Rod end nut	Rolled steel	
21	Magnet	—	

Dimensions

Basic

With rod end lock: C□BJ2B16-□□-RN

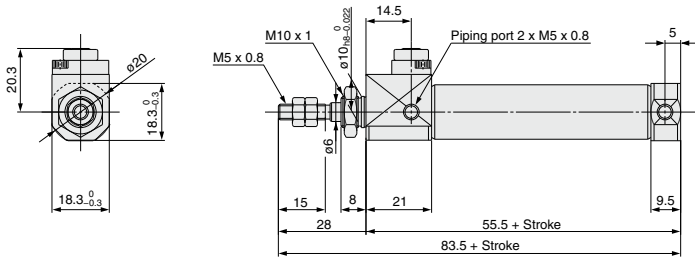

With head end lock: C□BJ2B16-□□-HN

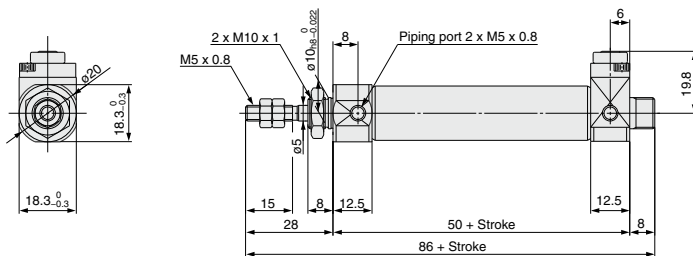

CBJ2 Series

Dimensions

Flange

With rod end lock: C□BJ2F16-□-RN

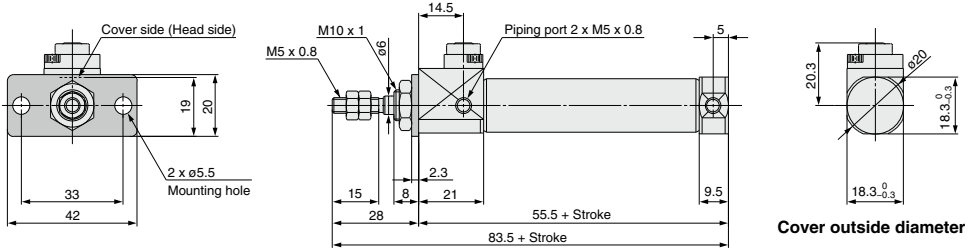

With head end lock: C□BJ2F16-□-HN

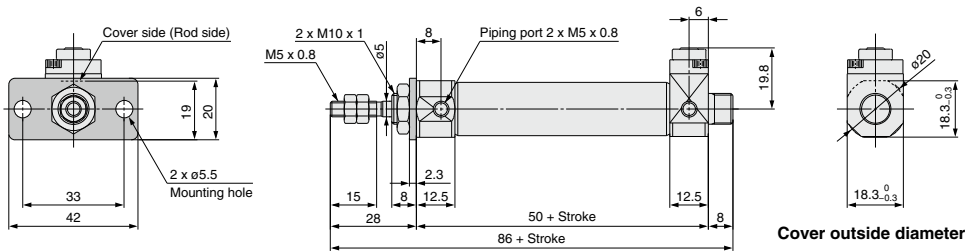

Dimensions

Axial foot

With rod end lock: C□BJ2L16-□□-RN

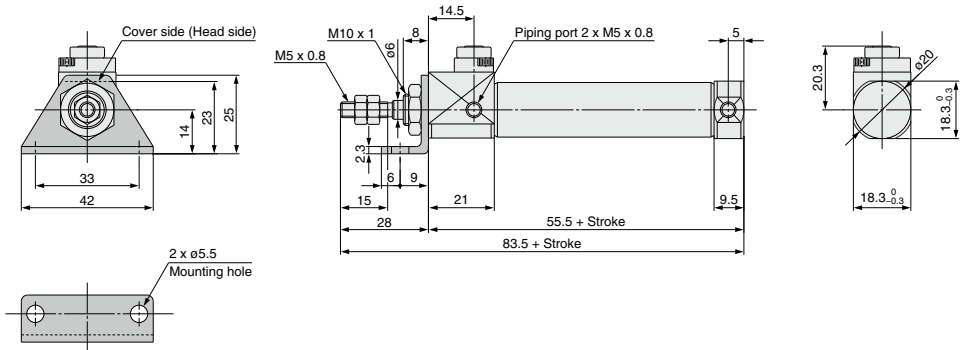

With head end lock: C□BJ2L16-□□-HN

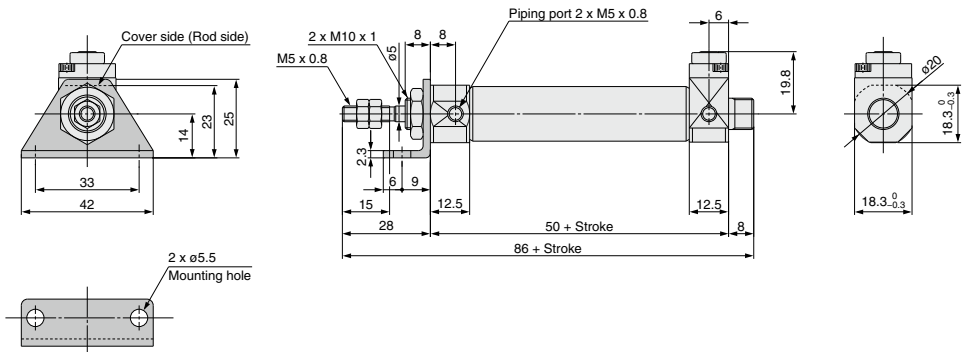

CBJ2 Series

Dimensions

Double clevis

With rod end lock: C□BJ2D16-□□-RN

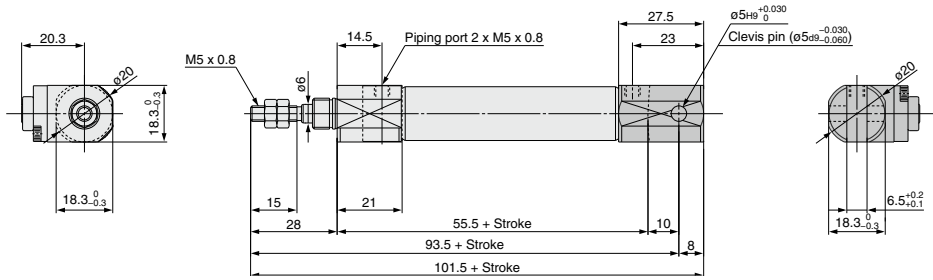



CBJ2 Series Specific Product Precautions

Be sure to read this before handling the products. Please consult with SMC for products outside these specifications.

Use Recommended Air Pressure Circuit.

⚠ Caution

- It is necessary for proper locking and unlocking.

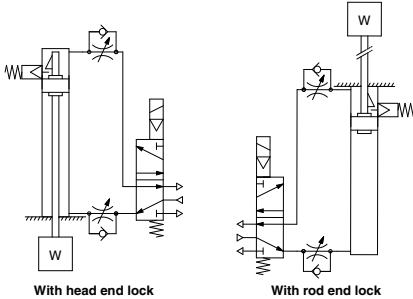

Operating Pressure

⚠ Caution

Supply air pressure of 0.15 MPa or higher to the port on the side that has the lock mechanism, as it is necessary for disengaging the lock.

Exhaust Air Speed

⚠ Caution

The lock will engage automatically if the air pressure at the port on the side that has the lock mechanism becomes 0.05 MPa or less. Be aware that if the piping on the side that has the lock mechanism is narrow and long, or if the speed controller is located far from the cylinder port, the exhaust air speed could become slower, involving a longer time for the lock to engage. A similar result will ensure if the silencer that is installed on the exhaust port of the solenoid valve becomes clogged.

Selection

⚠ Caution

- Do not use a 3-position solenoid valve.**
Avoid using this cylinder in combination with a 3-position solenoid valve (particularly the closed center metal seal type). If air pressure becomes sealed inside the port on the side that contains the lock mechanism, the lock will not engage. Even if the lock is engaged at first, the air that leaks from the solenoid valve could enter the cylinder and cause the lock to disengage as time elapses.
- Back pressure is necessary for unlocking.**
Before starting, make sure that air is supplied to the side that is not equipped with a lock mechanism as shown in the diagram above. Otherwise, the lock may not disengage. (Refer to "Lock Disengagement.")
- Disengage the lock before installing or adjusting the cylinder.**
The lock could become damaged if the cylinder is installed with its lock engaged.
- Operate the cylinder at a load ratio of 50% or less.**
The lock might not disengage or might become damaged if a load ratio of 50% is exceeded.
- Do not synchronize multiple cylinders.**
Do not operate two or more end lock cylinders synchronized to move a single workpiece because one of the cylinder locks may not be able to disengage when required.
- Operate the speed controller under meter-out control.**
If operated under meter-in control, the lock might not disengage.
- On the side that has a lock, make sure to operate at the stroke end of the cylinder.**
The lock might not engage or disengage if the piston of the cylinder has not reached the stroke end.
- The position adjustment of the auto switch should be performed at two positions; a position determined by the stroke and a position after the backlash movement (by 1 mm).**
When a 2-color indicator switch is adjusted to show green at the stroke end, the indication may turn red when the cylinder returns by the backlash. This, however, is not an error.

Lock Disengagement

⚠ Warning

To disengage the lock, make sure to supply air pressure to the port on the side without a lock mechanism, thus preventing the load from being applied to the lock mechanism. (Refer to the recommended air pressure circuit.) If the lock is disengaged when the port on the side that does not contain a lock mechanism is in the exhausted state and the load is being applied to the lock mechanism, undue force will be applied to the lock mechanism, and it may damage the lock mechanism. Also, it could be extremely dangerous, because the piston rod could move suddenly.

Manual Disengagement

⚠ Caution

Non-locking type manual release

Insert the bolt, which is provided as an accessory part, through the rubber cap (it is not necessary to remove the rubber cap). Screw the bolt into the lock piston and pull the bolt to disengage the lock. Releasing the bolt will re-engage the lock. The bolt size, pulling force, and the stroke are listed below.

Bore size [mm]	Thread size	Pulling force [N]	Stroke [mm]
16	M2 x 0.4 x 20 L or more	4.9	2

Bolt should be detached under normal operation, otherwise it may cause malfunction of the locking feature.

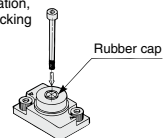

Auto Switch Mounting

Auto Switch Proper Mounting Position (Detection at stroke end) and Its Mounting Height

Solid state auto switch

<Band mounting>

- D-M9□
- D-M9□W
- D-M9□A

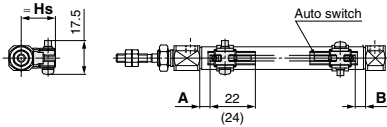

() : Dimension of the D-M9□A.
A and B are the dimensions from the end of the head cover/rod cover to the end of the auto switch.

- D-M9□V
- D-M9□MV
- D-M9□AV

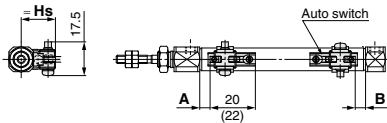

() : Dimension of the D-M9□AV.
A and B are the dimensions from the end of the head cover/rod cover to the end of the auto switch.

- D-H7□
- D-H7□W
- D-H7BA
- D-H7NF
- D-H7C

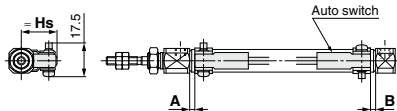

Reed auto switch

<Band mounting>

- D-A9□

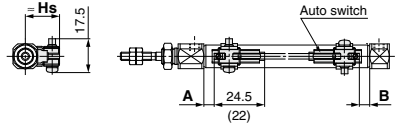

() : Dimension of the D-A96.
A and B are the dimensions from the end of the head cover/rod cover to the end of the auto switch.

- D-A9□V

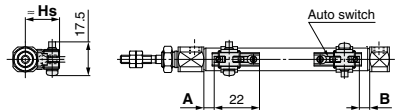

A and B are the dimensions from the end of the head cover/rod cover to the end of the auto switch.

- D-C7□/C80
- D-C73C□/C80C

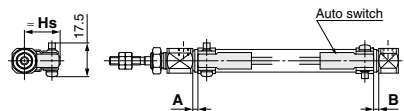

Auto Switch Proper Mounting Position (Detection at stroke end) and Its Mounting Height

<Rail mounting>

D-M9□
D-M9□W
D-M9□A

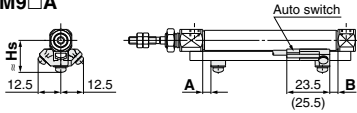

() : Dimension of the D-M9□A.

D-M9□V
D-M9□WV
D-M9□AV

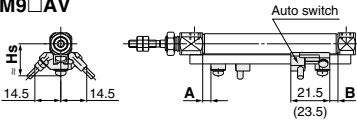

() : Dimension of the D-M9□AV.

D-F7□/J79
D-F7□W/J79W
D-F79F/F7BA

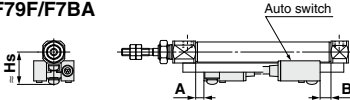

D-F7□V/F7□WV
D-F7BAV
D-J79C

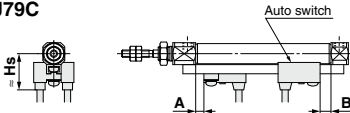

<Rail mounting>

D-A9□

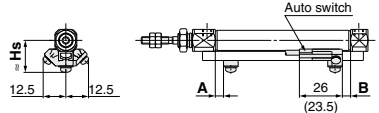

() : Dimension of the D-A96.

D-A9□V

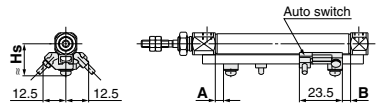

D-A7□/A80
D-A73C/A80C
D-A79W

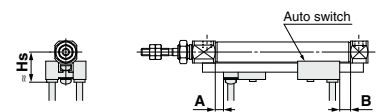

D-A7□H/A80H

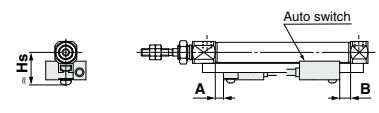

Auto Switch Proper Mounting Position (Detection at stroke end) and Its Mounting Height

Auto Switch Proper Mounting Position (Single acting type excluded) [mm]

Auto switch model	Band mounting							
	D-M9□ D-M9□V D-M9□W D-M9□WV D-M9□A D-M9□AV		D-A9□ D-A9□V		D-H7□ D-H7C D-H7NF D-H7□W D-H7BA		D-C7□ D-C80 D-C73C D-C80C	
Bore size	A	B	A	B	A	B	A	B
6	5.5 (4.5) [12]	5.5 (4.5) [4]	1.5 (0.5) [8]	1.5 (0.5) [0]	1 (7.5)	1 (0)	2 (8.5)	2 (0.5)
10	(5) 6	(5) 6	(1) 2	(1) 2	1.5	1.5	2.5	2.5
16	(5.5) 6.5	(5.5) 6.5	(1.5) 2.5	(1.5) 2.5	2	2	3	3

*: The values in () are measured from the end of the auto switch mounting bracket.

*: The values in [] are for bore size ø6 are for the double rod type (CJ2W series).

Auto switch model	Rail mounting											
	D-M9□ D-M9□V D-M9□W D-M9□WV D-M9□A D-M9□AV		D-A9□ D-A9□V		D-F7□/J79 D-F7□W/J79W D-F7□V/F7□WV D-F79F D-J79C D-F7BA D-F7BAV D-A7□H/A80H D-A73C/A80C		D-F7NT		D-A7□ D-A80		D-A79W	
Bore size	A	B	A	B	A	B	A	B	A	B	A	B
6	—	—	—	—	—	—	—	—	—	—	—	—
10	4.5	4.5	0.5	0.5	3.5	3.5	8.5	8.5	3	3	0.5	0.5
16	5	5	1	1	4	4	9	9	3.5	3.5	1	1

*: Adjust the auto switch after confirming the operating condition in the actual setting.

Auto Switch Mounting Height

Auto switch model	Band mounting								
	D-M9□ D-M9□W D-M9□A D-A9□		D-M9□V D-M9□WV D-M9□AV D-A9□V		D-H7□/H7□W D-H7NF D-H7BA D-C7□/C80		D-H7C	D-C73C D-C80C	
Bore size	Hs		Hs		Hs		Hs	Hs	
6	15		16		15		18	17.5	
10	17		18		17		20	19.5	
16	20.5		21		20.5		23.5	23	

Auto switch model	Rail mounting									
	D-M9□ D-M9□V D-M9□W D-M9□WV D-M9□A D-M9□AV D-A9□ D-A9□V		D-F7□/J79 D-F7□W/J79W D-F7BA/F79F D-F7NT D-A7□H/A80H		D-F7□V D-F7□WV D-F7BAV		D-J79C	D-A7□ D-A80	D-A73C D-A80C	D-A79W
Bore size	Hs		Hs		Hs		Hs	Hs	Hs	Hs
6	—		—		—		—	—	—	—
10	17.5		17.5		20		23	16.5	23.5	19
16	21		20.5		23		26	19.5	26.5	22

**Auto Switch Proper Mounting Position (Detection at stroke end)
and Its Mounting Height/Single Acting, Spring Return Type (S)**

Auto Switch Proper Mounting Position: Spring Return Type (S)

- Standard Type (CDJ2□□□□-□SZ)
- Non-rotating Rod Type (CDJ2K□□□□-□SZ)
- Direct Mount Type (CDJ2R□□□□-□SZ)
- Direct Mount, Non-rotating Rod Type (CDJ2RK□□□□-□SZ)

[mm]

Auto switch model	Bore size	A dimensions									B		
		5 to 9 st	10 to 15 st	16 to 30 st	31 to 45 st	46 to 60 st	61 to 75 st	76 to 100 st	101 to 125 st	126 to 150 st			
Band mounting	D-M9□	6	—	12	21	25	39	—	—	—	—	5.5	
	D-M9□W/M9□WV	10	—	13	20.5	32.5	44.5	—	—	—	—	6	
	D-M9□A/M9□AV	16	—	12.5	21	33	45	51	75	93	105	6.5	
	D-M9□V	6	12	12	21	25	39	—	—	—	—	5.5	
		10	13	13	20.5	32.5	44.5	—	—	—	—	6	
	D-A9□	6	—	8	17	21	35	—	—	—	—	1.5	
		10	—	9	16.5	28.5	40.5	—	—	—	—	2	
	D-A9□V	6	—	8.5	17	29	41	47	71	89	101	2.5	
		10	—	9	16.5	28.5	40.5	—	—	—	—	2	
		16	8.5	8.5	17	29	41	47	71	89	101	2.5	
	D-H7□/H7C D-H7□W/H7BA D-H7NF	6	—	7.5	16.5	20.5	34.5	—	—	—	—	1	
		10	—	8.5	16	28	40	—	—	—	—	1.5	
		16	—	8	16.5	28.5	40.5	46.5	70.5	88.5	100.5	2	
	D-C7□/C80 D-C73C D-C80C	6	—	8.5	17.5	21.5	35.5	—	—	—	—	2	
		10	—	9.5	17	29	41	—	—	—	—	2.5	
		16	—	9	17.5	29.5	41.5	47.5	71.5	89.5	101.5	3	
	Rail mounting	D-M9□ D-M9□W/M9□WV D-M9□A/M9□AV	10	—	11.5	19	31	43	—	—	—	—	4.5
			16	—	11	19.5	31.5	43.5	49.5	73.5	91.5	103.5	5
		D-M9□V	10	11.5	11.5	19	31	43	—	—	—	—	4.5
			16	11	11	19.5	31.5	43.5	49.5	73.5	91.5	103.5	5
		D-A9□	10	—	7.5	15	27	39	—	—	—	—	0.5
			16	—	7	15.5	27.5	39.5	45.5	69.5	87.5	99.5	1
		D-A9□V	10	7.5	7.5	15	27	39	—	—	—	—	0.5
			16	7	7	15.5	27.5	39.5	45.5	69.5	87.5	99.5	1
D-F7□/F7□V D-J79/J79C D-A7□H/A80H D-A73C/A80C		10	10.5	10.5	18	30	42	—	—	—	—	3.5	
		16	10	10	18.5	30.5	42.5	48.5	72.5	90.5	102.5	4	
D-F7□W/J79W D-F7□WV/F79F D-F7BA/F7BAV		10	—	10.5	18	30	42	—	—	—	—	3.5	
		16	—	10	18.5	30.5	42.5	48.5	72.5	90.5	102.5	4	
D-F7NT		10	—	15.5	23	35	47	—	—	—	—	8.5	
		16	—	15	23.5	35.5	47.5	53.5	77.5	95.5	107.5	9	
D-A7□/A80		10	10	10	17.5	29.5	41.5	—	—	—	—	3	
		16	9.5	9.5	18	30	42	48	72	90	102	3.5	
D-A79W		10	—	7.5	15	27	39	—	—	—	—	0.5	
		16	—	7	15.5	27.5	39.5	45.5	69.5	87.5	99.5	1	

*: In the actual setting, adjust them after confirming the auto switch performance.

Auto Switch Proper Mounting Position (Detection at stroke end) and Its Mounting Height/Single Acting, Spring Extend Type (T)

Auto Switch Proper Mounting Position: Spring Extend Type (T)

- Standard Type (CDJ2□□□-□TZ)
- Non-rotating Rod Type (CDJ2K□□□-□TZ)
- Direct Mount Type (CDJ2R□□□-□TZ)
- Direct Mount, Non-rotating Rod Type (CDJ2RK□□□-□TZ)

Auto switch model	Bore size	A	B dimensions									
			5 to 9 st	10 to 15 st	16 to 30 st	31 to 45 st	46 to 60 st	61 to 75 st	76 to 100 st	101 to 125 st	126 to 150 st	
Band mounting	D-M9□	6	5.5	—	12	21	25	39	—	—	—	—
	D-M9□W/M9□WV	10	6	—	13	20.5	32.5	44.5	—	—	—	—
	D-M9□A/M9□AV	16	6.5	—	12.5	21	33	45	51	75	93	105
	D-M9□V	6	5.5	12	12	21	25	39	—	—	—	—
		10	6	13	13	20.5	32.5	44.5	—	—	—	—
	D-A9□	16	6.5	12.5	12.5	21	33	45	51	75	93	105
		6	1.5	—	8	17	21	35	—	—	—	—
	D-A9□V	10	2	—	9	16.5	28.5	40.5	—	—	—	—
		16	2.5	—	8.5	17	29	41	47	71	89	101
	D-H7□/H7C	6	1.5	8	8	17	21	35	—	—	—	—
		10	2	9	9	16.5	28.5	40.5	—	—	—	—
	D-H7□W/H7BA	16	2.5	8.5	8.5	17	29	41	47	71	89	101
		6	1	—	7.5	16.5	20.5	34.5	—	—	—	—
	D-H7NF	10	1.5	—	8.5	16	28	40	—	—	—	—
		16	2	—	8	16.5	28.5	40.5	46.5	70.5	88.5	100.5
	D-C7□/C80	6	2	—	8.5	17.5	21.5	35.5	—	—	—	—
		10	2.5	—	9.5	17	29	41	—	—	—	—
	D-C73C	16	3	—	9	17.5	29.5	41.5	47.5	71.5	89.5	101.5
D-C80C		10	4.5	—	11.5	19	31	43	—	—	—	—
	D-M9□W/M9□WV	16	5	—	11	19.5	31.5	43.5	49.5	73.5	91.5	103.5
D-M9□V		10	4.5	11.5	11.5	19	31	43	—	—	—	—
	D-A9□	16	5	11	11	19.5	31.5	43.5	49.5	73.5	91.5	103.5
D-A9□V		10	0.5	—	7.5	15	27	39	—	—	—	—
	D-A9□V	16	1	—	7	15.5	27.5	39.5	45.5	69.5	87.5	99.5
D-F7□/F7□V		10	0.5	7.5	7.5	15	27	39	—	—	—	—
	D-J79/J79C	16	1	7	7	15.5	27.5	39.5	45.5	69.5	87.5	99.5
D-A7□H/A80H		10	3.5	10.5	10.5	18	30	42	—	—	—	—
	D-A73C/A80C	16	4	10	10	18.5	30.5	42.5	48.5	72.5	90.5	102.5
D-F7□W/J79W		10	3.5	—	10.5	18	30	42	—	—	—	—
	D-F7□WV/F79F	16	4	—	10	18.5	30.5	42.5	48.5	72.5	90.5	102.5
D-F7BA/F7BAV		10	8.5	—	15.5	23	35	47	—	—	—	—
	D-F7NT	16	9	—	15	23.5	35.5	47.5	53.5	77.5	95.5	107.5
D-A7□/A80		10	3	10	10	17.5	29.5	41.5	—	—	—	—
	D-A79W	16	3.5	9.5	9.5	18	30	42	48	72	90	102
D-A79W		10	0.5	—	7.5	15	27	39	—	—	—	—
	D-A79W	16	1	—	7	15.5	27.5	39.5	45.5	69.5	87.5	99.5

*: In the actual setting, adjust them after confirming the auto switch performance.

Minimum Stroke for Auto Switch Mounting

		[mm]				
Auto switch mounting	Auto switch model	Number of auto switches				
		With 1 pc.	With 2 pcs.		With n pcs. (n: Number of auto switches)	
			Different surfaces	Same surface	Different surfaces	Same surface
Band mounting	D-M9□ D-M9□W D-M9□A D-A9□	10	15*1	45*1	$15 + 35 \frac{(n-2)}{2}$ (n = 2, 4, 6...)*3	45 + 15 (n - 2) (n = 2, 3, 4, 5...)
	D-M9□V	5	15*1	35	$15 + 35 \frac{(n-2)}{2}$ (n = 2, 4, 6...)*3	35 + 25 (n - 2) (n = 2, 3, 4, 5...)
	D-M9□WV D-M9□AV	10	15*1	35	$15 + 35 \frac{(n-2)}{2}$ (n = 2, 4, 6...)*3	35 + 25 (n - 2) (n = 2, 3, 4, 5...)
	D-A9□V	5	10	35	$10 + 35 \frac{(n-2)}{2}$ (n = 2, 4, 6...)*3	35 + 25 (n - 2) (n = 2, 3, 4, 5...)
	D-H7□/H7□W D-H7BA D-H7NF	10	15	60	$15 + 45 \frac{(n-2)}{2}$ (n = 2, 4, 6...)*3	60 + 22.5 (n - 2) (n = 2, 3, 4, 5...)
	D-C7□ D-C80	10	15	50	$15 + 40 \frac{(n-2)}{2}$ (n = 2, 4, 6...)*3	50 + 20 (n - 2) (n = 2, 3, 4, 5...)
	D-H7C D-C73C D-C80C	10	15	65	$15 + 50 \frac{(n-2)}{2}$ (n = 2, 4, 6...)*3	50 + 27.5 (n - 2) (n = 2, 3, 4, 5...)
Rail mounting	D-M9□V	5	—	5	—	10 + 10 (n - 2) (n = 4, 6...)*4
	D-A9□V	5	—	10	—	10 + 15 (n - 2) (n = 4, 6...)*4
	D-M9□ D-A9□	10 (5)*5	—	10	—	15 + 15 (n - 2) (n = 4, 6...)*4
	D-M9□WV D-M9□AV	10	—	15	—	15 + 15 (n - 2) (n = 4, 6...)*4
	D-M9□W	15 (10)*5	—	15	—	20 + 15 (n - 2) (n = 4, 6...)*4
	D-M9□A	15 (10)*5	—	20 (15)*5	—	20 + 15 (n - 2) (n = 4, 6...)*4
	D-F7□ D-J79	5	—	5	—	15 + 15 (n - 2) (n = 4, 6...)*4
	D-F7□V D-J79C	5	—	5	—	10 + 10 (n - 2) (n = 4, 6...)*4
	D-F7□W/J79W D-F7BA/F79F/F7NT	10	—	15	—	15 + 20 (n - 2) (n = 4, 6...)*4
	D-F7□WV D-F7BAV	10	—	15	—	10 + 15 (n - 2) (n = 4, 6...)*4
	D-A7□/A80 D-A7□H/A80H D-A73C/A80C	5	—	10	—	15 + 10 (n - 2) (n = 4, 6...)*4
	D-A7□H D-A80H	5	—	10	—	15 + 15 (n - 2) (n = 4, 6...)*4
	D-A79W	10	—	15	—	10 + 15 (n - 2) (n = 4, 6...)*4

- *3: When "n" is an odd number, an even number that is one larger than this odd number is used for the calculation.
- *4: When "n" is an odd number, an even number that is one larger than this odd number is used for the calculation. However, the minimum even number is 4. So, 4 is used for the calculation when "n" is 1 to 3.
- *5: The dimension stated in () shows the minimum mountable stroke when the auto switch does not project from the end face of the cylinder body and the lead wire bending space is not hindered.

*1: Auto switch mounting

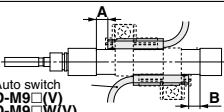
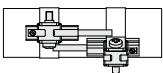
Auto switch model	With 2 auto switches	
	Different surfaces*1	Same surface*1
 <p>Auto switch D-M9□(V) D-M9□W(V) D-M9□A(V)</p> <p>The proper auto switch mounting position is 5.5 mm inward from the switch holder edge. The above A and B indicate values for band mounting in the table of page 174.</p>	 <p>The auto switch is mounted by slightly displacing it in a direction (cylinder tube circumferential exterior) so that the auto switch and lead wire do not interfere with each other.</p>	
D-M9□/M9□W/M9□A	Less than 20 stroke*2	Less than 55 stroke*2
D-A9□	—	Less than 50 stroke*2

*2: Minimum stroke for auto switch mounting in types other than those mentioned in *1.

Operating Range

Auto switch model	Bore size [mm]			
	6	10	16	
Band mounting	D-M9□/M9□V D-M9□W/M9□WV D-M9□A/M9□AV	2	2.5	3
	D-A9□	4.5	6	7
	D-H7□/H7□W D-H7BA/H7NF	3	4	4
	D-H7C	5	8	9
	D-C7□/C80/C73C/C80C	6	7	7
Rail mounting	D-M9□/M9□V D-M9□W/M9□WV D-M9□A/M9□AV	—	3	3.5
	D-A9□/A9□V	—	6	6.5
	D-F7□/J79/F7□W/J79W D-F7□V/F7□WV/F79F D-J79C/F7BA/F7BAV D-F7NT	—	5	5
	D-A7□/A80/A7H/A80H D-A73C/A80C	—	8	9
	D-A79W	—	11	13

*: Values which include hysteresis are for guideline purposes only, they are not a guarantee (assuming approximately ±30% dispersion) and may change substantially depending on the ambient environment.

Auto Switch Mounting Brackets/Part No.

Auto switch mounting	Auto switch model	Bore size [mm]		
		6	10	16
Band mounting	D-M9□ D-M9□V D-M9□W D-M9□WV D-A9□ D-A9□V	BJ6-006 (A set of a, b, d, f)	BJ6-010 (A set of a, b, c, d)	BJ6-016 (A set of a, b, c, d)
	D-M9□A *2 D-M9□AV *2	BJ6-006S (A set of a, b, d, g)	BJ6-010S (A set of a, b, d, e)	BJ6-016S (A set of a, b, d, e)
Band mounting				
Band mounting	D-H7□/H7□W D-H7BA/H7NF D-C7□/C80 D-C73C/C80C	BJ2-006 (A set of band and screw)	BJ2-010 (A set of band and screw)	BJ2-016 (A set of band and screw)
Rail mounting	D-M9□ D-M9□V D-M9□W D-M9□WV D-M9□A *4 D-M9□AV *4 D-A9□ D-A9□V	—	BQ2-012 (S) (A set of a and b)	BQ2-012 (S) (A set of a and b)

*1: Since the switch bracket (made from nylon) are affected in an environment where alcohol, chloroform, methylamines, hydrochloric acid or sulfuric acid is splashed over, so it cannot be used. Please contact SMC regarding other chemicals.

*2: As the indicator LED is projected from the auto switch unit, indicator LED may be damaged if the switch bracket is fixed on the indicator LED.

*3: When the cylinder is shipped, the auto switch mounting bracket and the auto switch will be included.

*4: For D-M9□A(V), order the BQ2-012S, which uses stainless steel mounting screws.

Band Mounting Brackets Set Part No.

Set part no.	Contents	Bore size [mm]		
		6	10	16
BJ2-□□□	• Auto switch mounting band (a) • Auto switch mounting screw (b)	BJ2-006	BJ2-010	BJ2-016
BJ4-1	• Switch bracket (White/PBT) (e) • Switch holder (d)	—	●	●
BJ4-2	• Switch bracket (Black/PBT) (g) • Switch holder (d)	●	—	—
BJ5-1	• Switch bracket (Transparent/Nylon) (c)*1 • Switch holder (d)	—	●	●
BJ5-2	• Switch bracket (Transparent blue/Nylon) (f)*1 • Switch holder (d)	●	—	—

[Stainless Steel Mounting Screw]

The following stainless steel mounting screw kit is available. Use it in accordance with the operating environment. (Since the auto switch mounting bracket is not included, order it separately.)

BBA4: For D-C7/C8/H7 types

*5: Refer to page 1370 for details on the BBA4.

When the D-H7BA type auto switch is shipped independently, the BBA4 is attached.

Other than the applicable auto switches listed in “How to Order”, the following auto switches are mountable.

Refer to pages 1271 to 1365 for the detailed specifications.

Type	Mounting	Model	Electrical entry	Features	Applicable bore size
Solid state	Band mounting	D-H7A1/H7A2/H7B	Grommet (In-line)	—	ø6 to ø16
		D-H7NW/H7PW/H7BW		Diagnostic indication (2-color indicator)	
		D-F79/F7P/J79		—	
	Rail mounting	D-F79W/F7PW/J79W	Grommet (Perpendicular)	Diagnostic indication (2-color indicator)	ø10, ø16
		D-F7NV/F7PV/F7BV		—	
		D-F7NWW/F7BWV		Diagnostic indication (2-color indicator)	
Reed	Band mounting	D-C73/C76	Grommet (In-line)	—	ø6 to ø16
		D-C80		Without indicator light	
	Rail mounting	D-A73H/A76H	Grommet (In-line)	—	ø10, ø16
		D-A80H		Without indicator light	
		D-A73	Grommet (Perpendicular)	—	
		D-A80		Without indicator light	

*: With pre-wired connector is also available for solid state auto switches. For details, refer to pages 1340 and 1341.

*: Normally closed (NC = b contact) solid state auto switches (D-M9□E(V)) are also available. For details, refer to page 1290.



1 PTFE Grease

Symbol
-X446

Applicable Series

Description	Model	Action	Note
Standard type	CJ2	Double acting, Single rod	
		Single acting (Spring return/extend)	
Non-rotating rod type	CJ2W	Double acting, Double rod	
		Double acting, Single rod	
Built-in speed controller type	CJ2K	Double acting, Single rod	
		Single acting (Spring return/extend)	
Direct mount type	CJ2Z	Double acting, Single rod	
		Double acting, Double rod	
Direct mount, Non-rotating rod type	CJ2ZW	Double acting, Single rod	
		Single acting (Spring return/extend)	

How to Order

Standard model no.

- X446

PTFE grease ●

Specifications: Same as standard type

Dimensions: Same as standard type

*: When grease is necessary for maintenance, grease pack is available, please order it separately.
GR-F-005 (Grease: 5 g)

Warning Precautions

Be aware that smoking cigarettes etc. after your hands have come into contact with the grease used in this cylinder can create a gas that is hazardous to humans.

Symbol

-X773

2 Short Pitch Mounting/Single Acting, Spring Return

Mounting pitch is shortened when cylinders are used in parallel.

- Changes rod cover and head cover dimensions to $\phi 7$.
- Shortens the full length with a head cover integrated with a barb fitting.

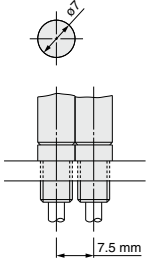

*: Directly mounted with cylinder mounting screws

Application example

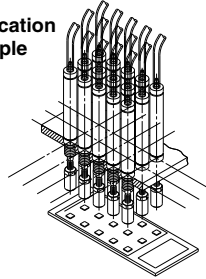

Verification of push button actuation for mobile phones etc.

Applicable Series

Description	Model	Action	Note
Standard type	CJ2	Single acting (Spring return)	

How to Order

CJ2B6 - **Stroke** SU4Z - X773

- Short pitch mounting/
Single acting, spring return



Specifications

Bore size [mm]	6
Action	Single acting, Spring return
Operating pressure range	0.2 to 0.7 MPa
Port size	With $\phi 4$ barb fitting (For soft tube)
Connecting port location	Head cover/Axial direction
Stroke [mm]	5 to 60
Auto switch	None

Dimensions

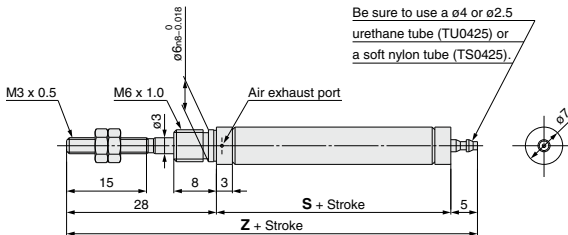

	[mm]			
Stroke	5 to 15	16 to 30	31 to 45	46 to 60
S	30.5	39.5	43.5	57.5
Z	63.5	72.5	76.5	90.5

Note

1. When mounting a cylinder, make sure that the air exhaust port on the rod cover is not blocked.
2. When mounting a cylinder, apply thread locking adhesive on the threaded part and hold the external diameter of the rod cover with a needle-nose pliers or regular pliers.

3 Double Clevis (With One-touch Connecting Pin)

With pivot bracket (T-bracket) and one-touch connecting pin
Not necessary to order a bracket for the applicable cylinder separately.

Applicable Series

Applicable Cylinders (Double Clevis Type)

Series	Bore size [mm]	Type	Model	Action	Note
CJ2D	10, 16	Standard	CJ2D	Double acting, Single rod	Cannot be mounted on cylinders with air cushion, or rail mounting type auto switches.
			CJ2D	Single acting, Single rod (Spring return/extend)	
		Non-rotating rod type	CJ2KD	Double acting, Single rod	
			CJ2KD	Single acting, Single rod (Spring return/extend)	

How to Order

Example) **CDJ2D10-60Z-N-M9BW-B-X2838**

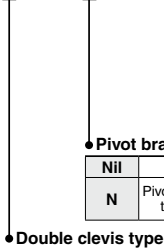

• **With one-touch connecting pin**

*: The pivot bracket (T-bracket) and one-touch connecting pin are shipped together. Refer to page 93 for assembly instructions.

• **Pivot bracket (T-bracket)**

Nil	None
N	Pivot bracket is shipped together with the product, but not assembled.

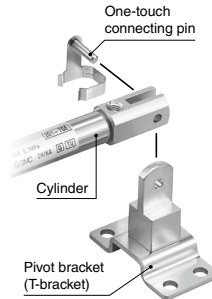

Specifications: Same as standard type

Dimensions

CJ2D $\frac{10}{16}$ - Stroke Z - (N) - X2838

*: Refer to page 93 for assembly procedures and mounting methods.

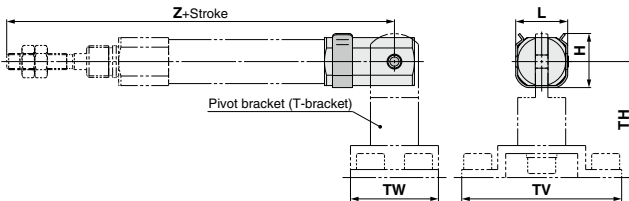

Applicable bore size	[mm]					
	H	L	TH	TV	TW	Z
10	13.4	13.2	29	40	22	82
16	18.2	19.5	35	48	28	85

*: The pivot bracket (T-bracket) is the same as the standard type. Refer to page 92 for details.

Specific Product Precautions



Be sure to read this before handling the products. Refer to page 20 for safety instructions and pages 21 to 30 for actuator and auto switch precautions.

Mounting

⚠ Warning

1. Use within the specified cylinder speed and kinetic energy ranges.

Otherwise, cylinder and seal damage may occur.

2. Do not apply excessive lateral load to the piston rod.

Easy checking method

Minimum operating pressure after the cylinder is mounted to the equipment (MPa) = Minimum operating pressure of cylinder (MPa) + {Load weight (kg) × Friction coefficient of guide/Sectional area of cylinder (mm²)}

If smooth operation is confirmed within the above value, the load on the cylinder is the resistance of the thrust only and it can be judged as having no lateral load.

3. Do not open the cushion needle after rotating it numerous times in a row. Though uncommon, there are cases in which the cushion needle may leak air.

The cushion needle should be adjusted by gradually opening it while checking the operation of the cylinder cushion.

4. Do not apply any torque to the cover joint.

Both the rod cover and head cover have wrench flats. When mounting the product, be sure to tighten with an appropriate amount of force.

When mounting the cylinder or screwing a fitting into the port, tighten while holding the cover on the mounting side with a wrench. In other words, do not hold the cover on the opposite side with a wrench. The applied torque may damage the cover joint part.

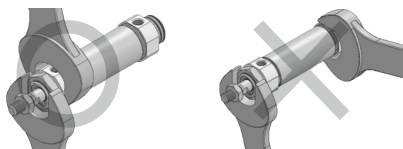

⚠ Caution

1. Tighten the retaining screws to an appropriate tightening torque within the range given below.

ø6: 2.1 to 2.5 N·m, ø10: 5.9 to 6.4 N·m

ø16: 10.8 to 11.8 N·m

2. To remove and install the retaining ring for the knuckle pin or the clevis pin, use an appropriate pair of pliers (tool for installing a type C retaining ring). In particular, use a pair of ultra-mini pliers for removing and installing the retaining ring on the ø10 cylinder.

3. In the case of auto switch rail mounting type, do not remove the rail that is mounted. Because retaining screws extend into the cylinder, this could lead to an air leak.

4. Please contact SMC when the stroke exceeds 100 mm for the axial foot mounting type.

<Precautions on the single acting cylinder>

- 1) Do not operate it in such a way that a load would be applied during the retraction of the piston rod of the spring return type, or during the extension of the piston rod of the spring extend type. The spring that is built into the cylinder provides only enough force to retract the piston rod. Thus, if a load is applied, the piston rod will not be able to retract to the end of the stroke.
- 2) A breather hole is provided in the cover surface. Make sure not to block this hole during installation, as this could lead to a malfunction.

<Precautions on the non-rotating cylinder>

- 1) Tighten the retaining screws to an appropriate tightening torque within the range given below.
ø10: 10.8 to 11.8 N·m, ø16: 20 to 21 N·m
- 2) Do not operate it in such a way that rotational torque would be applied to the piston rod. If rotational torque is applied, the non-rotating guide will become deformed, thus affecting the non-rotating accuracy.

Allowable rotational torque [N·m]	ø10	ø16
		0.02

- 3) To screw a bracket onto the threaded portion at the tip of the piston rod, make sure to retract the piston rod entirely, and place a wrench over the flat portion of the rod that protrudes. To tighten, take precautions to prevent the tightening torque from being applied to the non-rotating guide.

