

3-Color Display

Digital Flow Switch

Applicable fluid **Dry air, N₂**



IP65

IO-Link
* For the PFMC7□-L

The PFMC7 series is to be discontinued as of October 2021. Please consider ordering the new PF2MC7 series as a substitute. See [here](#) for details.

3-color/2-screen display*1

*1 2-row display of main screen and sub screen

Expanded flow range

A wide range of flow measurement is possible with 1 product.

Flow ratio*2 **100:1**

*2 Rated flow ratio is 10 : 1 for the existing PF2A series model.

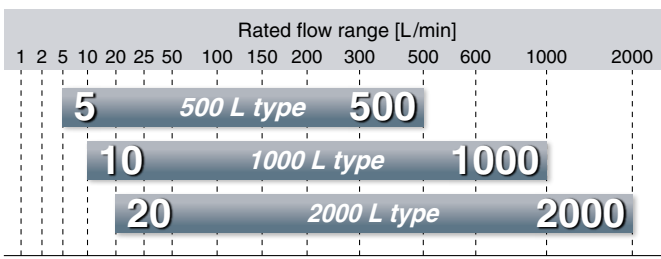

Smallest settable increment **1 L/min**

5 L/min for the for the existing PF2A series model

New

IO-Link Compatible

The flow rate value and the device status can be figured out easily via the process data. [p. 2](#)

Diagnosis items

- Over current error
- Above the rated/accumulated flow range
- Below the rated/accumulated flow range
- Internal product malfunction



3-Screen Display
Digital Flow Monitor
Allows for the monitoring of remote lines



PFG300 Series

PFMC7□(-L) Series



CAT.ES100-115C [Ⓐ]

3-Color Display Digital Flow Switch

PFMC7(-L) Series p. 9



Rotary display

Display can be rotated in increments of 45° to suit the installation conditions. Easy operation, improved visibility

Counterclockwise 90°
Clockwise 225°

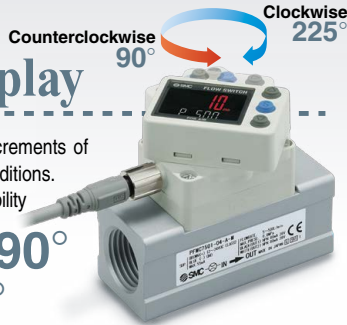

Functions pp. 24, 25

- Output operation
- Display color
- Reference condition
- Display mode
- Response time
- External input function
- Forced output function
- Accumulated value hold
- Selection of display on sub screen
- Display OFF mode
- Setting of security code
- Peak/Bottom value display
- Key-lock function
- Analog output free range function
- Error display function

Installation example

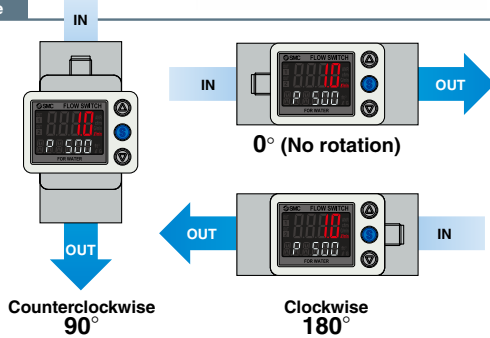

Bypass structure

Bypass structure with protruding part at the main piping, reduces the contact of moist air with the sensor, reducing degradation of the sensor and maintaining accuracy.

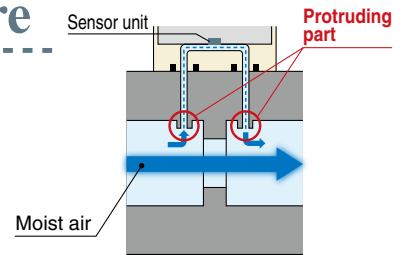

Response time (Digital filter)

Can be selected from **50 ms (0.05 s)** / **0.1 s** / **0.5 s** / **1.0 s** / **2.0 s**

Response time can be set depending on application.
* For IO-Link compatible products, 5.0 s can also be selected.

Grease-free

Applications

■ Flow control of equipment, main line and branch line

Remote control is possible with accumulated pulse.

Refer to the **Web Catalog** for details of the multi-counter CEU5.

■ The accumulated indication shows the operating flow rate or residual amount (of N₂, etc.) in a gas cylinder.

■ Flow control of the air for spray painting

* The product is not designed to be explosion proof.

Example of recommended pneumatic circuit

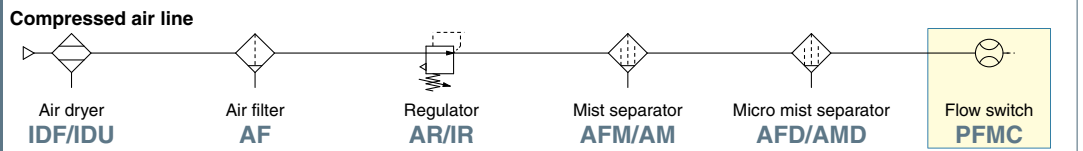

* Recommended air quality class: JIS B 8392-1 1.1.2 to 1.6.2 (ISO 8753-1 1.1.2 to 1.6.2)

Select a digital flow switch to increase energy savings!

Flow control is necessary for promoting energy saving in any application. Saving energy starts from numerical control of the flow consumption of equipment and lines and clarification of the purpose and effect.

- Digital display allows **visualization**.
- **3-color/2-screen** display, Improved visibility
- Remote control is possible with accumulated pulse.

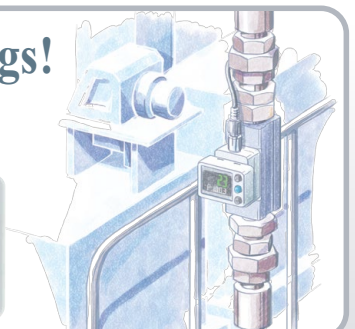

IO-Link Compatible PPMC7□-□□-L□-□□□

Supports the IO-Link communication protocol

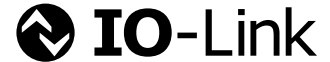

IO-Link is an open communication interface technology between the sensor/actuator and the I/O terminal that is an international standard: IEC 61131-9.

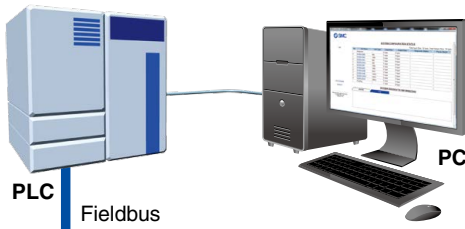

Configuration File (IODD File*1)
 · Manufacturer · Product part no. · Set value

*1 IODD File:
 IODD is an abbreviation of IO Device Description. This file is necessary for setting the device and connecting it to a master. Save the IODD file on the PC to be used to set the device prior to use.

Device settings can be set by the master.

- Threshold value
- Operation mode, etc.

Read the device data.

- Switch ON/OFF signal and analog value
- Device information: Manufacturer, Product part number, Serial number, etc.
- Normal or abnormal device status
- Cable breakage

IO-Link Master

IO-Link Compatible Device:
 Digital Flow Switch for Air

Implement diagnostic bits in the process data.

The diagnostic bit in the cyclic process data makes it easy to find problems with the equipment.

It is possible to find problems with the equipment in real time using the cyclic (periodic) data and to monitor such problems in detail with the noncyclic (aperiodic) data.

Process Data

Bit offset	Item	Note
0	OUT1 output	0: OFF 1: ON
1	OUT2 output	0: OFF 1: ON
8	Flow rate diagnosis	0: OFF 1: ON
14	Fixed output	0: OFF 1: ON
15	Error (Failure)	0: OFF 1: ON
16 to 31	Measured flow rate value	Signed 16 bit

Diagnosis items
• Over current error
• Above the rated flow range
• Above the accumulated flow range
• Below the rated flow range
• Below the accumulated flow range
• Internal product malfunction

Bit offset	31	30	29	28	27	26	25	24	23	22	21	20	19	18	17	16
Item	Measured flow rate value (PD)															

Bit offset	15	14	13	12	11	10	9	8	7	6	5	4	3	2	1	0
Item	Error (Failure)	Fixed output	Reservation					Flow rate diagnosis	Reservation					OUT2	OUT1	Switch output

Application Example

For the control of air consumption

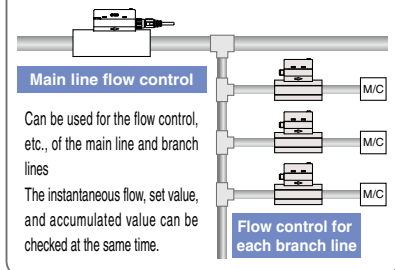

Display function

Displays the output communication status and indicates the presence of communication data



Operation and Display

Communication with master	IO-Link status indicator light	Status	Screen display*2	Description		
Yes	*1	Normal	Operate	Mode OpE	Normal communication status (readout of measured value)	
			Start up	Mode Start		
			Preoperate	Mode Pre		
No	*1 (Flashing)	Abnormal	Version does not match	Er 15 V 10	The IO-Link version does not match that of the master. * The applicable IO-Link version is 1.1.	
			Communication disconnection	Mode OpE		Normal communication was not received for 1 s or longer.
				Mode Start		
	OFF	SIO mode	Mode 5.10	General switch output		

*1 In IO-Link mode, the IO-Link indicator is ON or flashing. *2 When the lower line (sub screen) is set to mode display

* "ModE LoC" is displayed when the data storage lock is enabled. (Except for when the version does not match or when in SIO mode)

3-Screen Display Digital Flow Monitor

PFG300 Series p. 18



Allows for the monitoring of remote lines

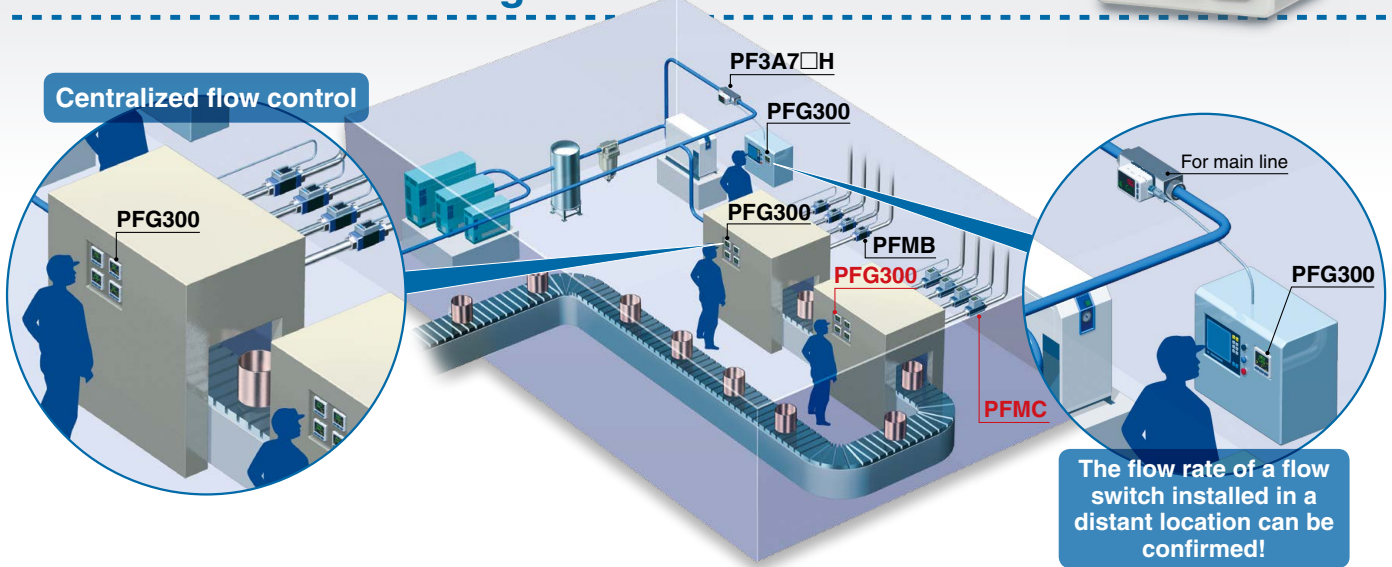

Visualization of settings

The sub screen (label) shows the item to be set.

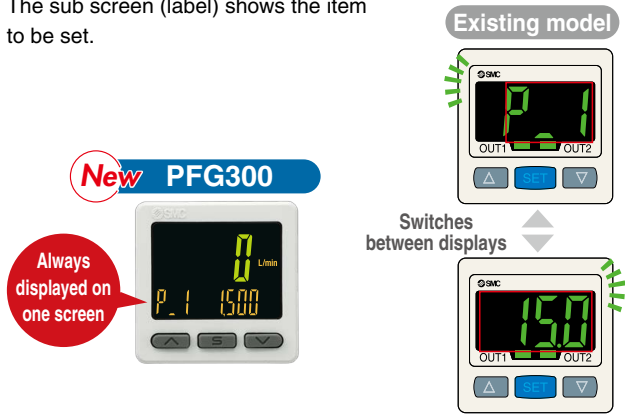

Mode Examples	Hysteresis mode					
	Normal output	Set value (Threshold value)	Reversed output	Set value (Threshold value)	Hysteresis	Set hysteresis value
	P.1	1500	n.1	1500	H.1	150
Mode Examples	Window comparator mode					
	Normal output/Lo side	Set value (Threshold value)	Normal output/Hi side	Set value (Threshold value)		
	P.L	900	P.H	1800		
	Reversed output/Lo side	Set value (Threshold value)	Reversed output/Hi side	Set value (Threshold value)		
	n.L	900	n.H	1800		

Easy screen switching

It is possible to change the settings while checking the measured value.

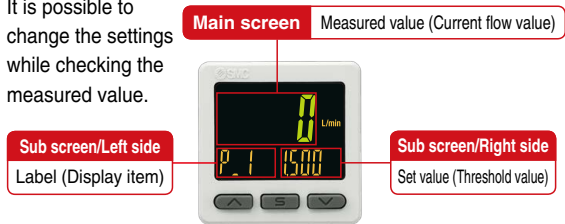

The sub screen can be switched by pressing the up/down buttons.

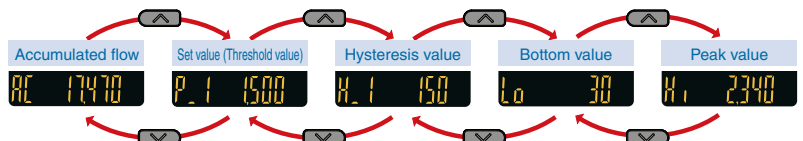

* Either "Input of line name" or "Display OFF" can be added via the function settings.

Simple 3-step setting

When the S button is pressed and the set value (P_1) is being displayed, the set value (threshold value) can be set. When the S button is pressed and the hysteresis (H_1) is being displayed, the hysteresis value can be set.

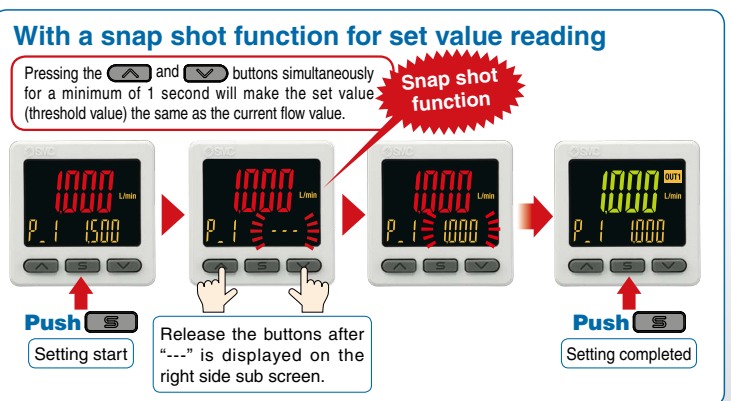
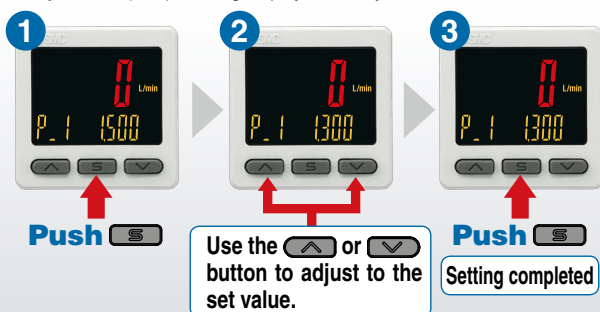

NPN/PNP switch function

The number of stock items can be reduced.

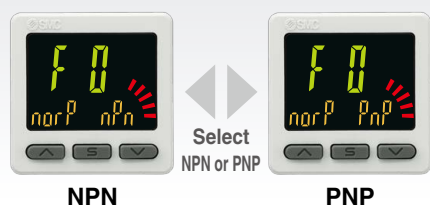

Analog output of 0 to 10 V is also available.

Voltage output	1 to 5 V	Switchable
	0 to 10 V	
Current output	4 to 20 mA	Fixed

Convenient functions

● Copy function

The set values of the monitor can be copied.

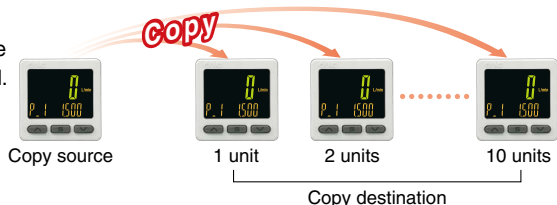

● Security code

The key locking function keeps unauthorized persons from tampering with the settings.

● Power saving function

Power consumption is reduced by turning off the monitor.

Current consumption*1	Reduction rate*2
25 mA or less	Approx. 50% reduction

*1 During normal operation *2 In power saving mode

● External input function

The accumulated value, peak value, and bottom value can be reset remotely.

Functions pp. 26 to 28

- Output operation
- Simple setting mode
- Display color
- Delay time setting
- Digital filter setting
- FUNC output switching function
- Selectable analog output function
- External input function
- Forced output function
- Accumulated value hold
- Peak/Bottom value display
- Setting of security code
- Key-lock function
- Reset to the default settings
- Display with zero cut-off setting
- Selection of display on sub screen
- Analog output free range function
- Error display function
- Copy function
- Selection of power saving mode

Mounting

Bracket configuration allows for mounting in four orientations.

Bracket A

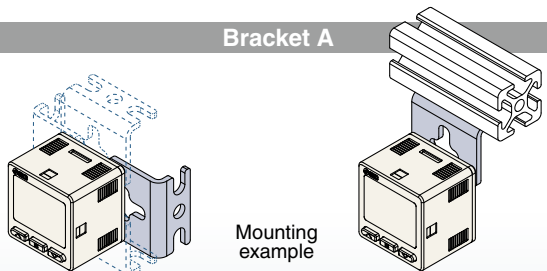

Bracket B

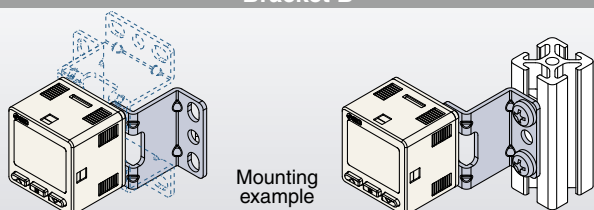

Panel mounting

Mountable side by side without clearance

One opening!

- Reduced panel fitting labor
- Space saving

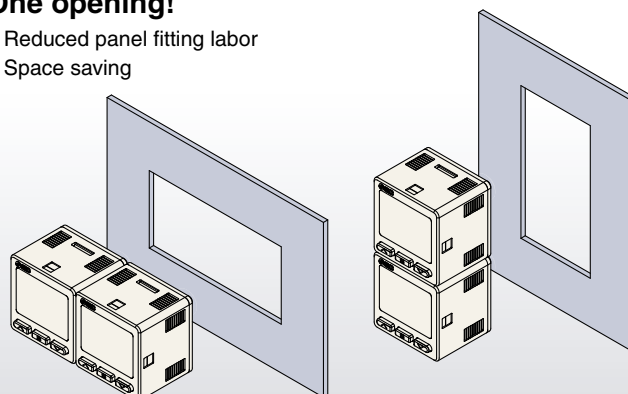

Input range selection (for Pressure/Flow rate)

The displayed value to the sensor input can be set as required.

(Voltage input: 1 to 5 V/Current input: 4 to 20 mA)

Pressure switch/Flow switch can be displayed.

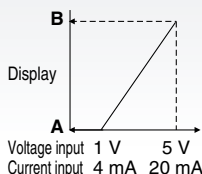

A is displayed for 1 V (or 4 mA).
B is displayed for 5 V (or 20 mA).
The range can be set as required.

■ Pressure Sensor for General Fluids/PSE570

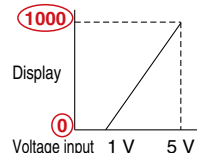

	A	B
PSE570	0	1000
PSE573	-100	100
PSE574	0	500

Set A and B to the values shown in the table above.





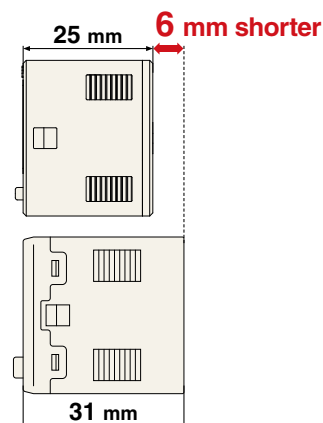



Compact & Lightweight

- Compact: Max. 6 mm shorter
- Lightweight: Max. 5 g lighter (30 g → 25 g)



Flow Switch Flow Rate Variations

Series	Applicable fluid	Detection method	Rated flow range [L/min]										
			-3	-2	-1	-0.5	0	0.5	1	2	3		
PFMV 	Dry air N ₂	Thermal type (MEMS)				0	0.5						
						0	1						
						0	3						
						-0.5	0.5						
						-1	1						
			-3	3									

Series	Applicable fluid	Detection method	Smallest settable increment	Rated flow range [L/min]																		
				0.1	0.2	0.5	1	2	5	10	20	25	50	100	150	200	300	500	600	1000	2000	3000
PF2M7(-L) 	Dry air N ₂ Ar CO ₂	Thermal type (MEMS)	0.001 L/min			0.01	1															
			0.01 L/min			0.02	2															
						0.05	5															
			0.1 L/min			0.1	10															
		0.3		25																		
		0.5		50																		
PFMB  PFG300 	Dry air N ₂	Thermal type (MEMS)	1 L/min			2	200															
						5	500															
		Bypass flow type			10	1000																
			20	2000																		
PFMC7(-L) <p>p. 9</p>  PFG300 <p>p. 18</p> 	Dry air N ₂	Thermal type (MEMS)	1 L/min			5	500															
						10	1000															
						20	2000															
PF2A 	Air N ₂	Thermal type (Thermistor)	0.1 L/min			1	10															
			0.5 L/min			5	50															
			1 L/min			10	100															
			2 L/min			20	200															
			5 L/min			50	500															
PF3A7□H(-L)  Large flow type  Modular type PFG300 	Air N ₂	Thermal type (Platinum sensor)	2 L/min			30	Large flow type		3000													
			5 L/min			60	Large flow type		6000													
			10 L/min			120	Large flow type		12000													
		Bypass flow type			1 L/min			10	Modular type		1000											
					2 L/min			20	Modular type		2000											

Flow Switch Variations / Basic Performance Table

Series	PFMV	PF2M7(-L)	PFMB	PFMC7(-L) p. 9	PF2A	PF3A7□H(-L)
Enclosure	IP40	IP40	IP40	IP65 [Monitor unit: IP40]	IP65	IP65 [Monitor unit: IP40]
Fluid	Dry air, N ₂	Dry air, N ₂ , Ar, CO ₂	Dry air, N ₂	Dry air, N ₂	Air, N ₂	Air, N ₂
Setting	Digital	Digital	Digital	Digital	Digital	Digital
Rated flow range [L/min]	0 to 0.5 0 to 1 0 to 3	-0.5 to 0.5 -1 to 1 -3 to 3	0.01 to 1 0.02 to 2 0.05 to 5 0.1 to 10 0.3 to 25 0.5 to 50 1 to 100	5 to 500 10 to 1000 20 to 2000	1 to 10 5 to 50 10 to 100 20 to 200 50 to 500	30 to 3000 60 to 6000 120 to 12000
Power supply voltage	12 to 24 VDC ±10%	PF2M7 12 to 24 VDC ±10% PF2M7-L 18 to 30 VDC ±10%	12 to 24 VDC ±10%	PFMC 12 to 24 VDC ±10% PFMC-L 18 to 30 VDC ±10%	12 to 24 VDC ±10%	PF3A7□H 24 VDC ±10% PF3A7□H-L 18 to 30 VDC ±10% PF3A701/ 702H-L 21.6 to 30 VDC
Temperature characteristics (25°C standard)	±2% F.S. (15 to 35°C) ±5% F.S. (0 to 50°C) [Monitor unit: ±0.5% F.S. (0 to 50°C)]	±3% F.S. ±1 digit (15 to 35°C) ±5% F.S. ±1 digit (0 to 50°C)	±2% F.S. (15 to 35°C) ±5% F.S. (0 to 50°C) [Monitor unit: ±0.5% F.S. (0 to 50°C)]	±2% F.S. (15 to 35°C) ±5% F.S. (0 to 50°C) [Monitor unit: ±0.5% F.S. (0 to 50°C)]	±3% F.S. (15 to 35°C) ±5% F.S. (0 to 50°C)	±5% F.S. (0 to 50°C) [Monitor unit: ±0.5% F.S. (0 to 50°C)]
Repeatability	±2% F.S. (Fluid: Dry air) Analog output: ±5% F.S. [Monitor unit: ±0.1% F.S. Analog output: ±0.3% F.S.]	±1% F.S. ±1 digit (Fluid: Dry air)	±1% F.S. (Fluid: Dry air) [Monitor unit: ±0.1% F.S. ±1 digit]	±1% F.S. (Fluid: Dry air) [Monitor unit: ±0.1% F.S. ±1 digit]	±1% F.S. (PF2A7□0) ±2% F.S. (PF2A7□1)	±1% F.S. [Monitor unit: ±0.1% F.S. ±1 digit]
Hysteresis	Hysteresis mode: Variable Window comparator mode: Variable	Hysteresis mode: Variable Window comparator mode: Variable	Hysteresis mode: Variable Window comparator mode: Variable	Hysteresis mode: Variable Window comparator mode: Variable	Hysteresis mode: Variable Window comparator mode: Fixed (3 digits)	Hysteresis mode: Variable Window comparator mode: Variable
Output	NPN/PNP open collector Analog voltage output Analog current output	NPN/PNP open collector Accumulated pulse output Analog voltage output Analog current output	NPN/PNP open collector Accumulated pulse output Analog voltage output Analog current output	NPN/PNP open collector Accumulated pulse output Analog voltage output Analog current output	NPN/PNP open collector Accumulated pulse output	NPN/PNP open collector Accumulated pulse output Analog voltage output Analog current output
Display	[Monitor unit: 2-color LCD display]	2-color LCD display	2-color LED display 2-color LCD display [Monitor unit: 3-color LCD display]	3-color LCD display	LED display	3-color LCD display

* The monitor unit values are for the PFG300 and PFMV3.

CONTENTS

- 3-Color Display** Digital Flow Switch *PFMC7 Series*
- 3-Color Display** IO-Link Compatible
Digital Flow Switch *PFMC7-L Series*
- 3-Screen Display** Digital Flow Monitor *PFG300 Series*



3-Color Display Digital Flow Switch **PFMC7 Series**

How to Order p. 9

Specifications p. 10

3-Color Display IO-Link Compatible
Digital Flow Switch **PFMC7-L Series**

How to Order p. 11

Specifications p. 12

Flow Range p. 13

Analog Output p. 13

Pressure Loss p. 13

IN Side Straight Piping Length and Accuracy p. 13

Internal Circuits and Wiring Examples p. 14

Construction: Parts in Contact with Fluid p. 16

Dimensions p. 17

3-Screen Display Digital Flow Monitor **PFG300 Series**

How to Order p. 18

Specifications p. 19

Internal Circuits and Wiring Examples p. 20

Dimensions p. 21

PFMC7(-L)/Function Details p. 24

PFG300/Function Details p. 26

Safety Instructions Back cover

PFMC7

PFMC7-L

PFG300

Function
Details

3-Color Display

Digital Flow Switch

PFMC7 Series



The PFMC7 series is to be discontinued as of October 2021. Please consider ordering the new PF2MC7 series as a substitute. See [here](#) for details.

How to Order



PFMC 7 **501** - **04** - **A** - **M**

Rated flow range

501	5 to 500 L/min
102	10 to 1000 L/min
202	20 to 2000 L/min

Thread type

Nil	Rc
N	NPT
F	G*1

*1 ISO 228 compliant

Port size

Symbol	Port size	Rated flow range		
		501	102	202
04	1/2	●	●	—
06	3/4	—	—	●

Output specification

Symbol	OUT1	OUT2	Applicable monitor unit model
A	NPN	NPN	—
B	PNP	PNP	—
C	NPN	Analog (1 to 5 V)	PF300 series
D	NPN	Analog (4 to 20 mA)	PF310 series
E *2	PNP	Analog (1 to 5 V)	PF300 series
F *2	PNP	Analog (4 to 20 mA)	PF310 series
G *2	NPN	External input*3	—
H *2	PNP	External input*3	—

*2 Made to order

*3 Can be selected from accumulated value external reset or peak/bottom value reset

Calibration certificate

Nil	None
A *8	Yes

*8 Made to order
The certificate is in both English and Japanese.

Option 2

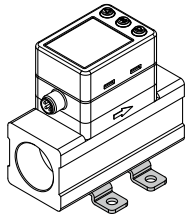
Nil	No bracket
R	With bracket*7 

*7 Options are shipped together with the product but do not come assembled.

Unit specification

Nil	Units selection function*5
M	SI units only*6

*5 This product is for overseas use only. (The SI unit type is provided for use in Japan in accordance with the New Measurement Act.)

*6 Fixed units: Instantaneous flow: L/min, Accumulated flow: L

Option 1

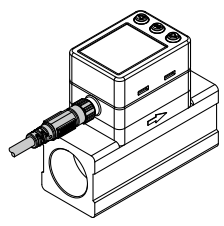
Nil	With lead wire with M8 connector (3 m)*4 
N	Without lead wire with M8 connector

*4 Options are shipped together with the product but do not come assembled.

Options/Part Nos.

When only optional parts are required, order with the part numbers listed below.

Part no.	Option	Note
ZS-40-A	Lead wire with M8 connector	Length: 3 m
ZS-42-A	Bracket	Mounting screw for PFMC7501/7102 (M3 x 5, 2 pcs.)
ZS-42-B	Bracket	Mounting screw for PFMC7202 (M3 x 5, 2 pcs.)

For flow switch precautions and specific product precautions, refer to the "Operation Manual" on the SMC website.

Specifications

Model		PFMC7501	PFMC7102	PFMC7202	
Fluid	Applicable fluid	Dry air, N ₂ (Air quality grade is JIS B 8392-1 1.1.2 to 1.6.2, ISO 8573-1 1.1.2 to 1.6.2.)			
	Fluid temperature range	0 to 50°C			
Flow	Detection method	Thermal type			
	Rated flow range	5 to 500 L/min	10 to 1000 L/min	20 to 2000 L/min	
	Set point range	Instantaneous flow	5 to 525 L/min	10 to 1050 L/min	20 to 2100 L/min
		Accumulated flow	0 to 999,999,990 L		
	Smallest settable increment	Instantaneous flow	1 L/min		
		Accumulated flow	10 L		
	Accumulated volume per pulse (Pulse width = 50 ms)	1 L/pulse	10 L/pulse		
Accumulated value hold function *1	Intervals of 2 or 5 minutes can be selected.				
Pressure	Rated pressure range	0 to 0.8 MPa			
	Proof pressure	1.2 MPa			
	Pressure loss	Refer to the "Pressure Loss" graph.			
	Pressure characteristics *2	±5% F.S. (0 to 0.8 MPa, 0.6 MPa standard)			
Electrical	Power supply voltage	12 to 24 VDC ±10% Ripple (p-p) 10% or less			
	Current consumption	55 mA or less			
	Protection	Polarity protection			
Accuracy	Display accuracy	±3% F.S.			
	Analog output accuracy	±3% F.S.			
	Repeatability	±1% F.S. (±2% F.S. when the response time is set to 0.05 s)			
	Temperature characteristics	±5% F.S. (0 to 50°C, 25°C standard)			
Switch output	Output type	NPN open collector PNP open collector			
	Output mode	Select from Hysteresis, Window comparator, Accumulated output, or Accumulated pulse output modes.			
	Switch operation	Select from Normal or Reversed output.			
	Max. load current	80 mA			
	Max. applied voltage (NPN only)	28 VDC			
	Internal voltage drop (Residual voltage)	NPN output type: 1 V or less (at load current of 80 mA) PNP output type: 1.5 V or less (at load current of 80 mA)			
	Response time *3	Select from 0.05 s, 0.1 s, 0.5 s, 1 s, or 2 s.			
	Hysteresis *4	Variable from 0			
	Protection	Short circuit protection			
Analog output *5	Output type	Voltage output: 1 to 5 V, Current output: 4 to 20 mA Output impedance: Approx. 1 kΩ			
	Impedance	Voltage output	Maximum load impedance at power supply voltage of 24 V: 600 Ω, at power supply voltage of 12 V: 300 Ω		
		Current output	Minimum load impedance: 50 Ω		
	Response time *6	Linked to the response time of the switch output			
External input *7	External input	Input voltage: 0.4 V or less (Reed or Solid state) for 30 ms or longer			
	Input mode	Accumulated value external reset, Peak/Bottom value reset			
Display	Reference condition *8	Select from Standard conditions or Normal conditions.			
	Unit *9	Instantaneous flow	L/min, cfm (ft ³ /min)		
		Accumulated flow	L, ft ³		
	Display range	Instantaneous flow	-25 to 525 L/min (Displays [0] when value is within the -4 to 4 L/min range)	-50 to 1050 L/min (Displays [0] when value is within the -9 to 9 L/min range)	-100 to 2100 L/min (Displays [0] when value is within the -19 to 19 L/min range)
		Accumulated flow *10	0 to 999,999,999 L		
	Minimum display unit	Instantaneous flow	1 L/min		
		Accumulated flow	10 L		
	Display	LCD, 2-screen display (Main screen/Sub screen) Main screen: Red/Green, Sub screen: White Main screen: 4 digits, 7 segments, Sub screen: 6 digits, 11 segments			
Indicator LED	LED ON when switch output is ON (OUT1/OUT2: Orange)				
Environmental resistance	Enclosure	IP65			
	Withstand voltage	250 VAC for 1 min between terminals and housing			
	Insulation resistance	2 MΩ or more (50 VDC measured via megohmmeter) between terminals and housing			
	Operating temperature range	Operating: 0 to 50°C, Stored: -10 to 60°C (No condensation or freezing)			
Operating humidity range	Operating/Stored: 35 to 85% RH (No condensation or freezing)				
Standards	CE marking (EMC Directive, RoHS Directive), UL (CSA)				
Piping specification	Rc1/2, NPT1/2, G1/2		Rc3/4, NPT3/4, G3/4		
Materials of parts in contact with fluid	Stainless steel 304, PPS, Aluminum alloy, HNBR, Si, Au, GE4F				
Weight	Piping specification	Rc thread NPT thread	160 g	240 g	
		G thread	170 g	245 g	
	Lead wire	+80 g			
	Bracket	+25 g		+30 g	

*1 When using the accumulated value hold function, use the operating conditions to calculate the product life, and do not exceed it. The maximum access limit of the memory device is 1 million times. If the product is operated 24 hours per day, the product life will be as follows:
 • 5 min interval: life is calculated as 5 min x 1 million = 5 million min = 9.5 years
 • 2 min interval: life is calculated as 2 min x 1 million = 2 million min = 3.8 years
 If the accumulated value external reset is repeatedly used, the product life will be shorter than the calculated life.
 *2 Do not release the OUT side piping part of the product directly to the atmosphere without connecting piping. If the product is used with the piping port released to atmosphere, accuracy may vary.
 *3 The time from when the flow is changed by a step input (when the flow rate changes from 0 to the maximum value of the rated flow range instantaneously) until the switch output turns ON (or OFF) when set to be 90% of the rated flow rate
 *4 If the flow fluctuates around the set value, be sure to keep a sufficient margin.

Otherwise, chattering will occur.
 *5 Setting is only possible for models with analog output.
 *6 The time from when the flow is changed by a step input (when the flow rate changes from 0 to the maximum value of the rated flow range instantaneously) until the analog output reaches 90% of the rated flow rate
 *7 Setting is only possible for models with external input.
 *8 The flow rate given in the specifications is the value under standard conditions.
 *9 Setting is only possible for models with the units selection function.
 *10 The accumulated flow display is the upper 3-digit and lower 6-digit (total of 9 digits) display. The position of the dots on the upper part of the screen indicates which digits are displayed.
 * Products with tiny scratches, marks, or display color or brightness variations which do not affect the performance of the product are verified as conforming products.

The PFMC7 series is to be discontinued as of October 2021. Please consider ordering the new PF2MC7 series as a substitute. See [here](#) for details.

How to Order



PFMC 7 501 - 04 - L Q - M

Type

7	Integrated display
---	--------------------

Rated flow range

501	5 to 500 L/min
102	10 to 1000 L/min
202	20 to 2000 L/min

Thread type

Nil	Rc
N	NPT
F	G*1

*1 ISO 228 compliant

Port size

Symbol	Port size	Rated flow range		
		501	102	202
04	1/2	●	●	—
06	3/4	—	—	●

Output specification

Symbol	OUT1	OUT2*2	Applicable monitor unit model
L	IO-Link/ Switch output (N/P)	—	—
L2	IO-Link/ Switch output (N/P)	Switch output (N/P) ⇔ External input*4	—
L3	IO-Link/ Switch output (N/P)	Analog voltage output*3	PFG300 series
L4	IO-Link/ Switch output (N/P)	Analog current output	PFG310 series

*2 Switch output (analog output) or external input can be selected by pressing the buttons. Switch output (analog output) is set as default setting. Output symbol "L" cannot be used as the OUT2 terminal is not connected.

*3 1 to 5 V or 0 to 10 V can be selected by pressing the button. The default setting is 1 to 5 V.

*4 Can be selected from accumulated value external reset or peak/bottom value reset

Calibration certificate

Nil	None
A*9	Yes

*9 Made to order

The certificate is in both English and Japanese.

Option 2

Nil	No bracket
R	With bracket*8

*8 Options are shipped together with the product but do not come assembled.

Unit specification

Nil	Units selection function*6
M	SI units only*7

*6 This product is for overseas use only. (The SI unit type is provided for use in Japan in accordance with the New Measurement Act.)

*7 Fixed units: Instantaneous flow: L/min, Accumulated flow: L

Option 1

Nil	With lead wire with M8 connector (3 m)*5
N	None
Q	With M12-M8 conversion lead wire (0.1 m)*5

*5 Options are shipped together with the product but do not come assembled.

Options/Part Nos.

When only optional parts are required, order with the part numbers listed below.

Part no.	Description	Note
ZS-40-A	Lead wire with M8 connector	Length: 3 m
ZS-42-A	Bracket	Mounting screw for PFMC7501/7102(-L) (M3 x 5, 2 pcs.)
ZS-42-B	Bracket	Mounting screw for PFMC7202(-L) (M3 x 5, 2 pcs.)
ZS-40-M12M8-A	M12-M8 conversion lead wire	Length: 0.1 m

ZS-40-M12M8-A

M12-M8 conversion lead wire

* The lead wire with an M8 connector and the M12-M8 conversion lead wire are interchangeable with those for the existing PFMC series.

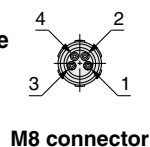

M8 connector

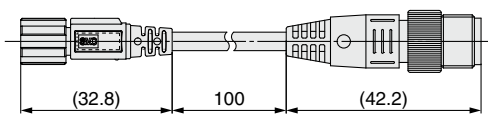

M12 connector

M8 (Female)	M12 (Male)
① Brown	①
② White	②
③ Blue	③
④ Black	④

Wiring diagram

* For wiring, refer to the Operation Manual on the SMC website, <https://www.smcworld.com>

For flow switch precautions and specific product precautions, refer to the "Operation Manual" on the SMC website.

Specifications

Model			PFMC7-L
Electrical	Power supply voltage	When used as a switch output device	12 to 24 VDC ±10%
		When used as an IO-Link device	18 to 30 VDC ±10%
Switch output	Output type		Select from NPN or PNP open collector output.
	Output mode		Select from Hysteresis, Window comparator, Accumulated output, Accumulated pulse output, Error output, or Switch output OFF modes.
	Max. applied voltage		30 V (NPN output)
	Internal voltage drop (Residual voltage)		1.5 V or less (at load current of 80 mA)
	Delay time*1		3.4 ms or less Variable from 0 to 60 s/0.01 s increments
Analog output	Response time*2		Linked to the set value of the digital filter
	Output type		Voltage output: 1 to 5 V (0 to 10 V can be selected, only when the power supply voltage is 24 VDC)*3, Current output: 4 to 20 mA
	Impedance	Voltage output	Output impedance: Approx. 1 kΩ
		Current output	Maximum load impedance: 600 Ω at power supply voltage of 24 V, 300 Ω at power supply voltage of 12 V
Display	Display		2-screen display (Main screen, Sub screen) Main screen: 4-digit, 7-segment, 2-color, Red/Green; Sub screen: 9-digit, 11-segment (Only the 5th digit is a 7-segment LED.), White Display values updated 5 times per second
Digital filter*4			Select from 0.05 s, 0.1 s, 0.5 s, 1.0 s, 2.0 s, or 5.0 s.
Standards			CE marking (EMC Directive, RoHS Directive)

- *1 The time from when the instantaneous flow reaches the set value to when the switch output operates can be set.
- *2 The time from when the flow is changed by a step input (when the flow rate changes from 0 to the maximum value of the rated flow range instantaneously) until the analog output reaches 90% of the rated flow rate
- *3 When selecting 0 to 10 V, refer to the analog output graph for the allowable load current.
- *4 The time for the digital filter can be set to the sensor input. The response time indicates when the set value is 90% in relation to the step input.

Communication Specifications (IO-Link mode)

IO-Link type	Device
IO-Link version	V 1.1
Communication speed	COM2 (38.4 kbps)
Configuration file	IODD file*1
Minimum cycle time	3.4 ms
Process data length	Input data: 4 bytes, Output data: 0 byte
On request data communication	Yes
Data storage function	Yes
Event function	Yes
Vendor ID	131 (0 x 0083)
Device ID*2	PFMC7501-□□-L□-□□□ : 541 (0 x 021D)
	PFMC7501-□□-L2□-□□□ : 542 (0 x 021E)
	PFMC7501-□□-L3□-□□□ : 543 (0 x 021F)
	PFMC7501-□□-L4□-□□□ : 544 (0 x 0220)
	PFMC7102-□□-L□-□□□ : 545 (0 x 0221)
	PFMC7102-□□-L2□-□□□ : 546 (0 x 0222)
	PFMC7102-□□-L3□-□□□ : 547 (0 x 0223)
	PFMC7102-□□-L4□-□□□ : 548 (0 x 0224)
	PFMC7202-□□-L□-□□□ : 549 (0 x 0225)
	PFMC7202-□□-L2□-□□□ : 550 (0 x 0226)
	PFMC7202-□□-L3□-□□□ : 551 (0 x 0227)
	PFMC7202-□□-L4□-□□□ : 552 (0 x 0228)

- *1 The configuration file can be downloaded from the SMC website, <https://www.smcworld.com>
- *2 The device ID differs according to each product type (output specification).

Other specifications that are not listed are the same as those of the standard product. For details, refer to page 10.

PFMC7

PFMC7-L

PFG300

Function Details

PFMC7(-L) Series

Flow Range

Model	Flow range					
	-100 L/min	0 L/min	200 L/min	500 L/min	1000 L/min	2000 L/min
PFMC7501(-L)		5 L/min	500 L/min			
		5 L/min	525 L/min			
		-25 L/min	525 L/min			
PFMC7102(-L)		10 L/min	1000 L/min			
		10 L/min	1050 L/min			
		-50 L/min	1050 L/min			
PFMC7202(-L)		20 L/min	2000 L/min			
		20 L/min	2100 L/min			
		-100 L/min	2100 L/min			

Rated flow range
 Set point range
 Display range

Analog Output

Flow/Analog Output

	0 L/min	A*2	B
Voltage output (1 to 5 V)*1	1 V	1.04 V	5 V
Current output*1	4 mA	4.16 mA	20 mA

	0 L/min	C*2	D
Voltage output (0 to 10 V)*1,3	0 V	0.1 V	10 V

- *1 Analog output accuracy is within $\pm 3\%$ F.S.
- *2 A and C will change according to the setting of the zero cut function.
- *3 The analog output current from the connected equipment should be $20 \mu\text{A}$ or less when selecting 0 to 10 V. When more than $20 \mu\text{A}$ current flows, it is possible that the accuracy is not satisfied below 0.5 V.
- * The minimum value of the rated flow range will change according to the setting of the zero cut function.

Model	Min. value of the rated flow range	Max. value of the rated flow range
PFMC7501(-L)	5 L/min	500 L/min
PFMC7102(-L)	10 L/min	1000 L/min
PFMC7202(-L)	20 L/min	2000 L/min

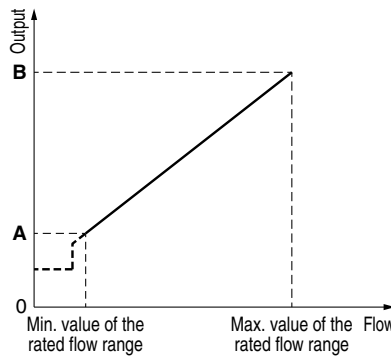

Voltage output (1 to 5 V)
Current output (4 to 20 mA)

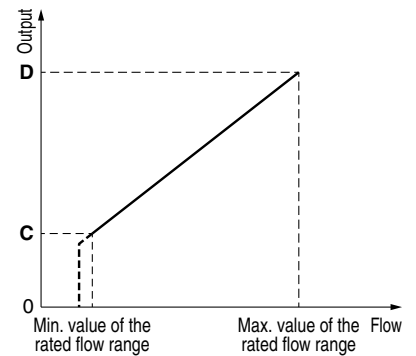

Voltage output (0 to 10 V)
* PFMC7-L only

Pressure Loss (Reference Data)

PFMC7501(-L) (for 500 L/min)

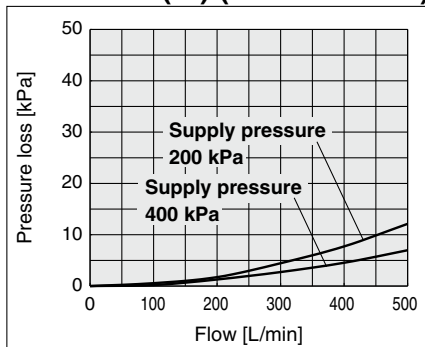

PFMC7102(-L) (for 1000 L/min)

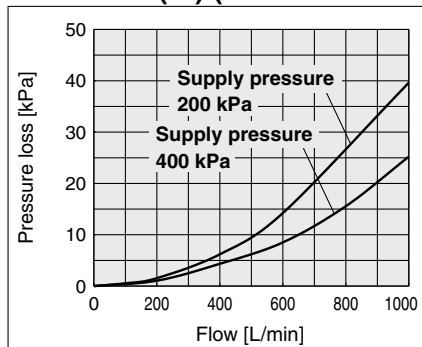

PFMC7202(-L) (for 2000 L/min)

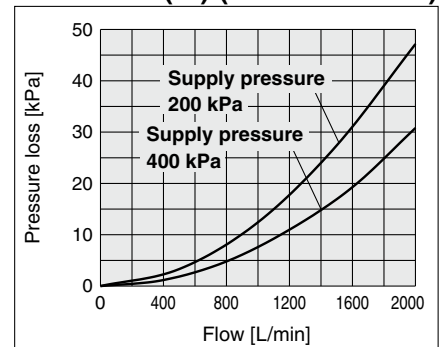

IN Side Straight Piping Length and Accuracy (Reference Data)

- The piping on the IN side must have a straight section of piping with a length of 8 cm or more. If a straight section of piping is not installed, the accuracy can vary by approximately $\pm 2\%$ F.S.
- * "Straight section" means a part of the piping without any bends or rapid changes in the cross sectional area.
- When the PFMC7501 or 7102 is connected to tubing, use a tube I.D. 9 mm or more just before the product. The accuracy can vary by approximately $\pm 2\%$ F.S. when such tubing is not used.

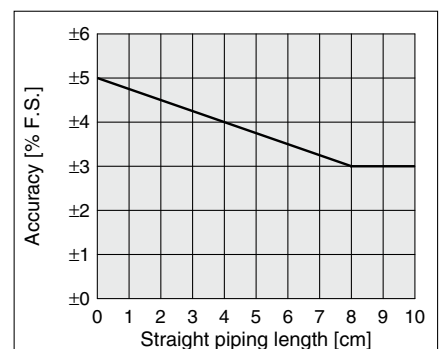
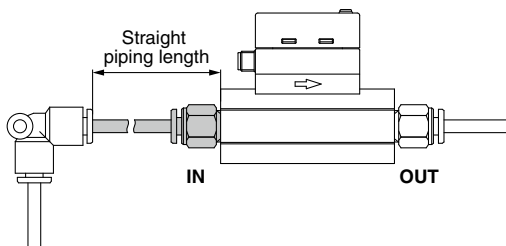

Internal Circuits and Wiring Examples

NPN (2 outputs) type

PFMC7□□□-□□-**A**□-□□□

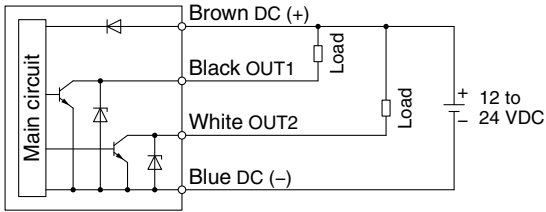

Max. applied voltage: 28 V, Max. load current: 80 mA, Internal voltage drop: 1 V or less

PNP (2 outputs) type

PFMC7□□□-□□-**B**□-□□□

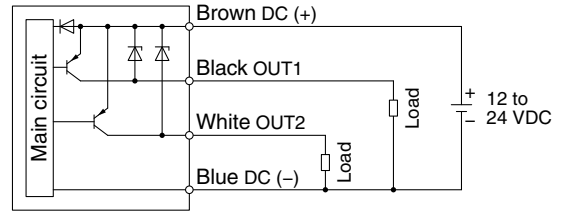

Max. load current: 80 mA, Internal voltage drop: 1.5 V or less

NPN (1 output) + Analog (1 to 5 V) output type

PFMC7□□□-□□-**C**□-□□□

NPN (1 output) + Analog (4 to 20 mA) output type

PFMC7□□□-□□-**D**□-□□□

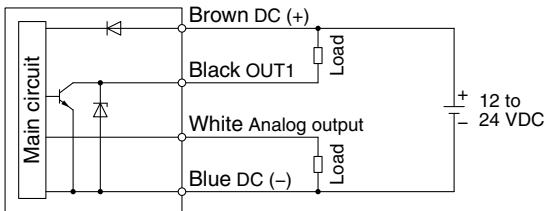

Max. applied voltage: 28 V, Max. load current: 80 mA, Internal voltage drop: 1 V or less

C: Analog output: 1 to 5 V

Output impedance: 1 kΩ

D: Analog output: 4 to 20 mA

Max. load impedance: 600 Ω

Min. load impedance: 50 Ω

PNP (1 output) + Analog (1 to 5 V) output type

PFMC7□□□-□□-**E**□-□□□

PNP (1 output) + Analog (4 to 20 mA) output type

PFMC7□□□-□□-**F**□-□□□

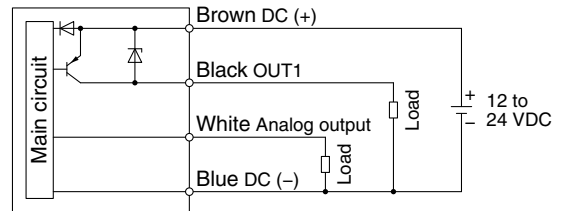

Max. load current: 80 mA, Internal voltage drop: 1.5 V or less

E: Analog output: 1 to 5 V

Output impedance: 1 kΩ

F: Analog output: 4 to 20 mA

Max. load impedance: 600 Ω

Min. load impedance: 50 Ω

NPN (1 output) + External input type

PFMC7□□□-□□-**G**□-□□□

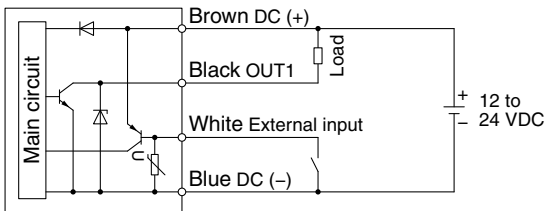

Max. applied voltage: 28 V, Max. load current: 80 mA, Internal voltage drop: 1 V or less

External input: Input voltage 0.4 V or less (Reed or Solid state input) for 30 ms or longer

PNP (1 output) + External input type

PFMC7□□□-□□-**H**□-□□□

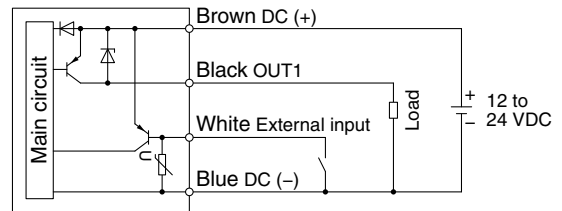

Max. load current: 80 mA, Internal voltage drop: 1.5 V or less

External input: Input voltage 0.4 V or less (Reed or Solid state input) for 30 ms or longer

Accumulated pulse output wiring examples

NPN (2 outputs) type

PFMC7□□□-□□-**A**□-□□□

NPN (1 output) + Analog output type

PFMC7□□□-□□-**C**□-□□□

PFMC7□□□-□□-**D**□-□□□

NPN (1 output) + External input type

PFMC7□□□-□□-**G**□-□□□

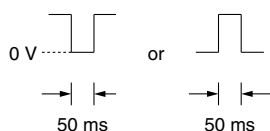
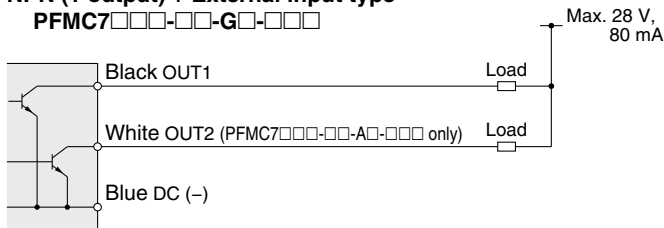

PNP (2 outputs) type

PFMC7□□□-□□-**B**□-□□□

PNP (1 output) + Analog output type

PFMC7□□□-□□-**E**□-□□□

PFMC7□□□-□□-**F**□-□□□

PNP (1 output) + External input type

PFMC7□□□-□□-**H**□-□□□

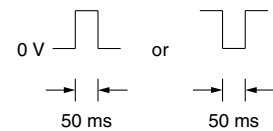
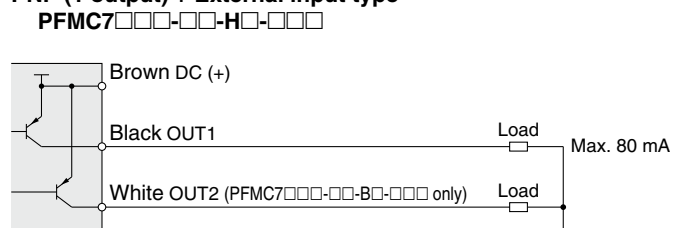

PFMC7(-L) Series

Internal Circuits and Wiring Examples

PFMC7□-□□-L□-□□

NPN output type

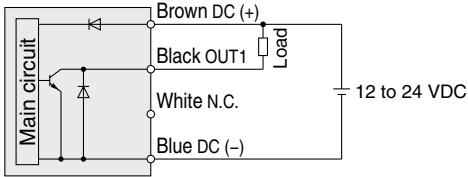

Max. applied voltage: 30 V, Max. load current: 80 mA, Internal voltage drop: 1.5 V or less

PNP output type

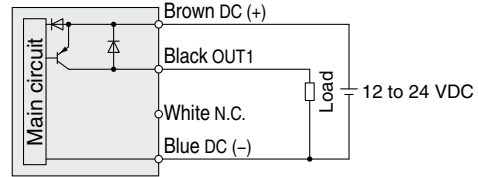

Max. load current: 80 mA, Internal voltage drop: 1.5 V or less

PFMC7□-□□-L2□-□□

NPN 2 output type

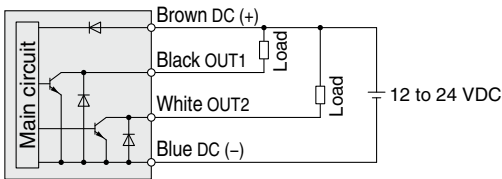

Max. applied voltage: 30 V, Max. load current: 80 mA, Internal voltage drop: 1.5 V or less

PNP 2 output type

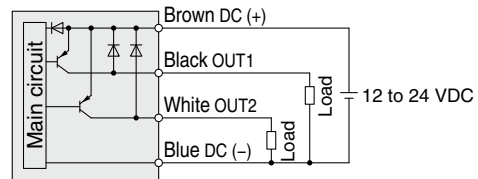

Max. load current: 80 mA, Internal voltage drop: 1.5 V or less

PFMC7□-□□-L3/L4□-□□

NPN + Analog output selected

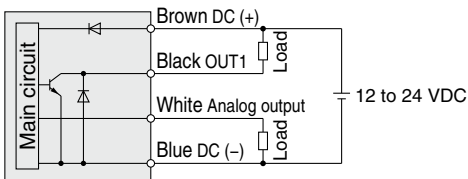

Max. applied voltage: 30 V, Max. load current: 80 mA, Internal voltage drop: 1.5 V or less
 L3: Analog output: 1 to 5 V or 0 to 10 V
 Output impedance: 1 k Ω
 L4: Analog output: 4 to 20 mA
 Max. load impedance: 600 Ω
 Min. load impedance: 50 Ω

PNP + Analog output selected

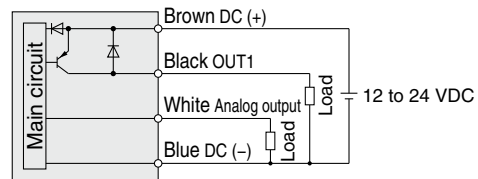

Max. load current: 80 mA, Internal voltage drop: 1.5 V or less
 L3: Analog output: 1 to 5 V or 0 to 10 V
 Output impedance: 1 k Ω
 L4: Analog output: 4 to 20 mA
 Max. load impedance: 600 Ω
 Min. load impedance: 50 Ω

PFMC7□-□□-L2□-□□

NPN + External input selected

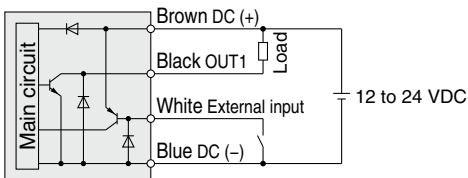

Max. applied voltage: 30 V, Max. load current: 80 mA, Internal voltage drop: 1.5 V or less
 External input voltage: 0.4 V or less (Reed or Solid state input) for 30 ms or longer

PNP + External input selected

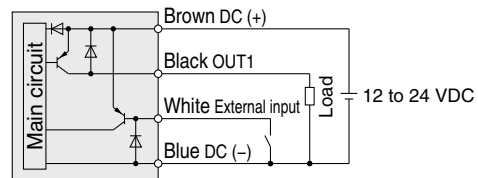

Max. load current: 80 mA, Internal voltage drop: 1.5 V or less
 External input voltage: 0.4 V or less (Reed or Solid state input) for 30 ms or longer

When used as an IO-Link device

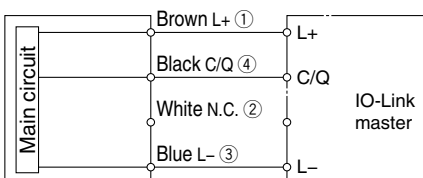

* The numbers in the diagrams show the connector pin layout.

Construction: Parts in Contact with Fluid

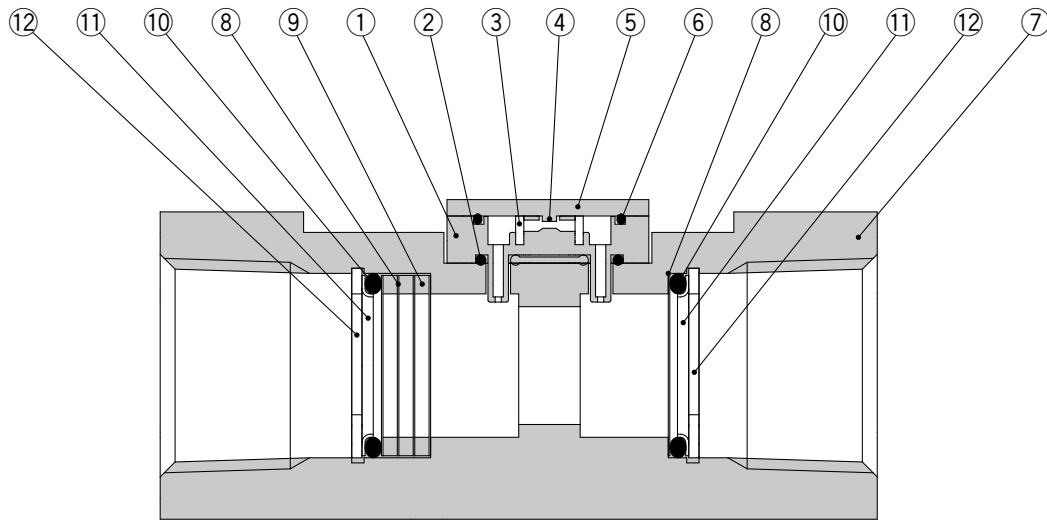

Component Parts

No.	Description	Material	Note
1	Sensor body	PPS	
2	Gasket	HNBR	
3	Flow rectifier	Stainless steel 304	
4	Sensor chip	Silicon	
5	Printed circuit board	GE4F	
6	Gasket	HNBR	
7	Body	Aluminum alloy	Anodized
8	Mesh	Stainless steel 304	
9	Spacer	PPS	
10	O-ring	HNBR	
11	Holder	Stainless steel 304	
12	C retaining ring	Stainless steel 304	

PFG300

PFG300(-L)

PFG300

Function
Details

PFMC7(-L) Series

Dimensions

PFMC7501/7102/7202(-L)

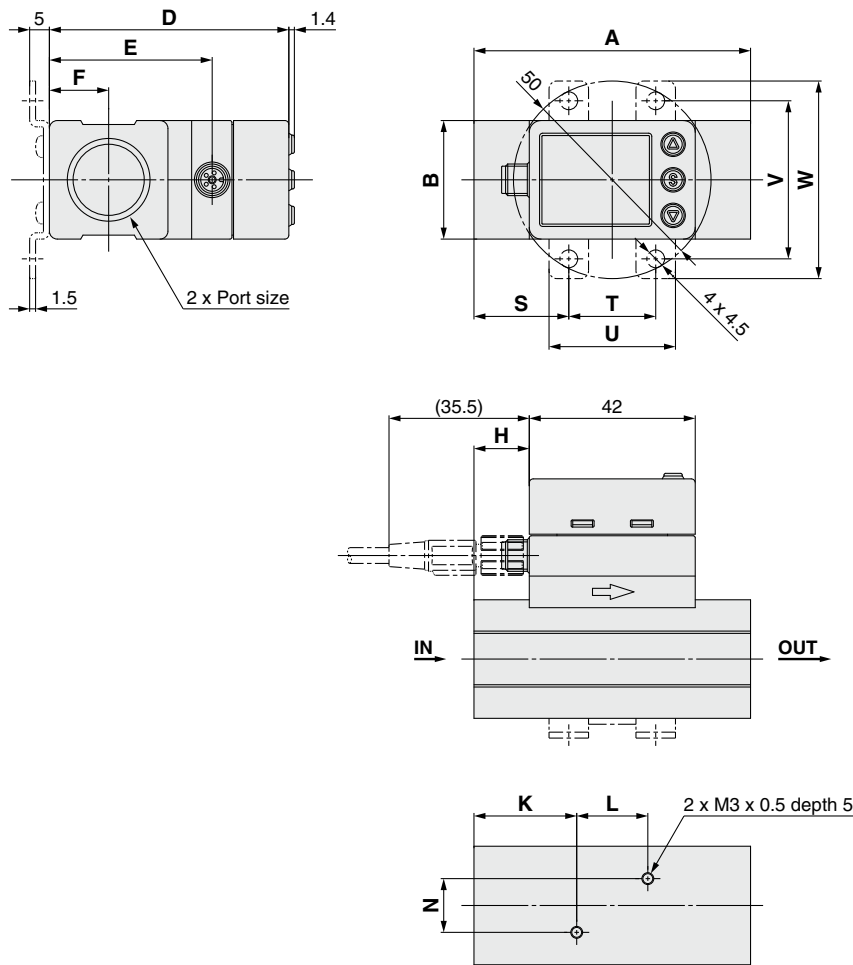

Model	Symbol	Port size	A	B	D	E	F	H	K	L	N
PFMC7501/7102(-L)		Rc1/2, NPT1/2	70	30	60.6	41.2	15	14	26	18	13.6
PFMC7202(-L)		Rc3/4, NPT3/4, G3/4	90	35	66.1	46.7	17.5	24	31	28	16.8
PFMC7501/7102(-L)		G1/2	76	30	60.6	41.2	15	14	26	18	13.6

Model	Symbol	Bracket dimensions				
		S	T	U	V	W
PFMC7501/7102(-L)		24	22	32	40	50
PFMC7202(-L)		30	30	42	48	58

Lead wire with M8 connector (Part no.: ZS-40-A)

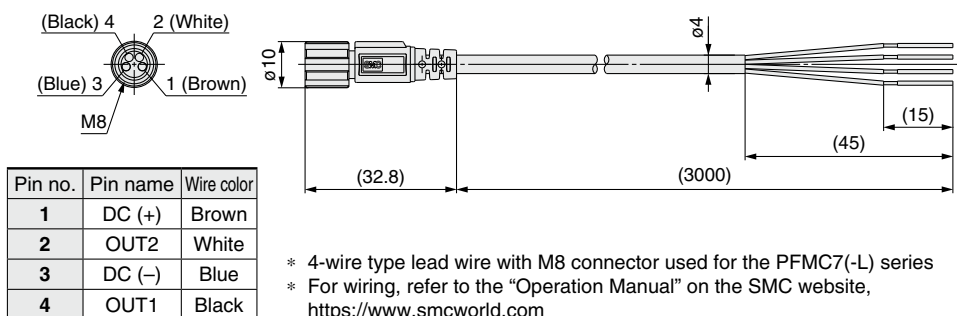

Pin no.	Pin name	Wire color
1	DC (+)	Brown
2	OUT2	White
3	DC (-)	Blue
4	OUT1	Black

* 4-wire type lead wire with M8 connector used for the PFMC7(-L) series
 * For wiring, refer to the "Operation Manual" on the SMC website,
<https://www.smcworld.com>

Cable Specifications

Conductor	Nominal cross section	AWG23
	Outside diameter	Approx. 0.7 mm
Insulator	Material	Heat-resistant PVC
	Outside diameter	Approx. 1.1 mm
	Color	Brown, White, Black, Blue
Sheath	Material	Heat- and oil-resistant PVC
Finished outside diameter		$\phi 4$

3-Screen Display

Digital Flow Monitor

PFG300 Series



How to Order

PFG 3 0 0 - RT - M - L [] [] []

Type

3	Remote type monitor unit
---	--------------------------

Input specification

Symbol	Description	Applicable flow switch model
0	Voltage input	PFMC7□-C/E/L3 series
1	Current input	PFMC7□-D/F/L4 series

* The PFG3 (monitor unit) cannot be used as an IO-Link communication device.

Output specification

Symbol	Description
RT	2 outputs (NPN/PNP switching type) + Analog voltage output*1, 2
SV	2 outputs (NPN/PNP switching type) + Analog current output*2
XY	2 outputs (NPN/PNP switching type) + Copy function

*1 Can switch between 1 to 5 V and 0 to 10 V

*2 Can be switched to external input or copy function

Unit specification

Symbol	Description
Nil	Units selection function*3
M	SI units only*4

*3 This product is for overseas use only. (The SI unit type is provided for use in Japan in accordance with the New Measurement Act.)

*4 Fixed units: Instantaneous flow: L/min
Accumulated flow: L

Option 4

	Operation manual	Calibration certificate
Nil	○	—
Y	—	—
K	○	○
T	—	○

Option 3

Symbol	Description
Nil	None
C	ZS-28-CA-4 Sensor connector

Option 1

Symbol	Description
Nil	Without lead wire
L	Power supply/output connection lead wire (Lead wire length: 2 m) ZS-46-5L Power supply/output connection lead wire

Option 2

Symbol	Description
Nil	None
A1	Bracket A (Vertical mounting) ZS-46-A1
A2	Bracket B (Horizontal mounting) ZS-46-A2
B	Panel mount adapter ZS-46-B
D	Panel mount adapter + Front protection cover ZS-46-D

Options/Part Nos.

When only optional parts are required, order with the part numbers listed below.

Part no.	Option	Note
ZS-28-CA-4	Sensor connector	For PFMC
ZS-46-A1	Bracket A	Tapping screw: Nominal size 3 x 8 L (2 pcs.)
ZS-46-A2	Bracket B	Tapping screw: Nominal size 3 x 8 L (2 pcs.)
ZS-46-B	Panel mount adapter	
ZS-46-D	Panel mount adapter + Front protection cover	
ZS-46-5L	Power supply/output connection lead wire	5-core, 2 m
ZS-27-01	Front protection cover	

Connection Example

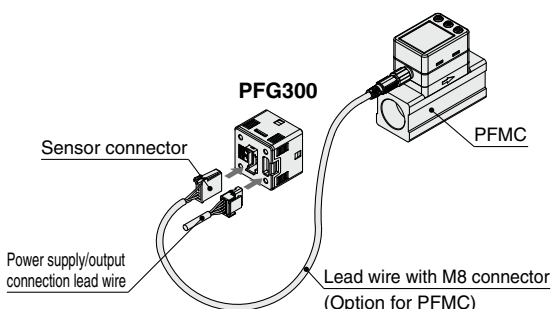

PFMC7

PFMC7-L

PFG300

Function Details

PFG300 Series

For flow switch precautions and specific product precautions, refer to the "Operation Manual" on the SMC website.

Specifications

Model		PFG300 series			
Applicable SMC flow switch	Model	PFMC7501	PFMC7102	PFMC7202	
	Rated flow range *1	5 to 500 L/min	10 to 1000 L/min	20 to 2000 L/min	
Flow	Set point range	Instantaneous flow	-25 to 525 L/min	-50 to 1050 L/min	
		Accumulated flow	0 to 999,999,999,990 L		
	Smallest settable increment	Instantaneous flow	1 L/min		
		Accumulated flow	10 L		
	Accumulated volume per pulse (Pulse width = 50 ms)	1 L/pulse	10 L/pulse		
	Accumulated value hold function *3	Intervals of 2 or 5 minutes can be selected. The stored accumulated flow is held even when the power supply is OFF.			
Electrical	Power supply voltage	12 to 24 VDC ±10%			
	Current consumption	25 mA or less			
	Protection	Polarity protection			
Accuracy	Display accuracy	±0.5% F.S. ± Minimum display unit (Ambient temperature at 25°C)			
	Analog output accuracy	±0.5% F.S. (Ambient temperature at 25°C)			
	Repeatability	±0.1% F.S. ±1 digit			
	Temperature characteristics	±0.5% F.S. (Ambient temperature: 0 to 50°C, 25°C standard)			
Switch output	Output type	Select from NPN or PNP open collector output.			
	Output mode	Select from Hysteresis, Window comparator, Accumulated output, Accumulated pulse output, Error output, or Switch output OFF modes.			
	Switch operation	Select from Normal or Reversed output.			
	Max. load current	80 mA			
	Max. applied voltage (NPN only)	30 VDC			
	Internal voltage drop (Residual voltage)	NPN output: 1 V or less (at load current of 80 mA), PNP output: 1.5 V or less (at load current of 80 mA)			
	Response time *2	3 ms or less			
	Delay time *2	Select from 0.00, 0.05 to 0.1 s (increment of 0.01 s), 0.1 to 1.0 s (increment of 0.1 s), 1 to 10 s (increment of 1 s), 20 s, 30 s, 40 s, 50 s, or 60 s.			
	Hysteresis *4	Variable from 0			
Analog output*5	Protection	Short circuit protection			
	Output type	Voltage output: 1 to 5 V, 0 to 10 V (only when the power supply voltage is 24 VDC) Current output: 4 to 20 mA (0 L/min to maximum value of the rated flow)			
	Impedance	Voltage output	Output impedance: 1 kΩ		
		Current output	Maximum load impedance: 300 Ω (at power supply voltage of 12 V), 600 Ω (at power supply voltage of 24 VDC)		
	Response time *2	50 ms or less			
External input*6	External input	Input voltage: 0.4 V or less (Reed or Solid state) for 30 ms or longer			
	Input mode	Select from Accumulated value external reset or Peak/Bottom value reset.			
Sensor input	Input type	Voltage input: 1 to 5 VDC (Input impedance: 1 MΩ), Current input: 4 to 20 mA DC (Input impedance: 51 Ω) (0 L/min to maximum value of the rated flow)			
	Connection method	Connector (e-CON)			
	Protection	Over voltage protection (Up to 26.4 VDC)			
Display	Display mode	Select from Instantaneous flow or Accumulated flow.			
	Unit *7	Instantaneous flow	L/min, cfm (ft ³ /min)		
		Accumulated flow	L, ft ³ , L x 10 ⁶ , ft ³ x 10 ⁶		
	Display range	Instantaneous flow	-25 to 525 L/min	-50 to 1050 L/min	-100 to 2100 L/min
		Accumulated flow*9	0 to 999,999,999,990 L		
	Minimum display unit	Instantaneous flow	1 L/min		
		Accumulated flow	10 L		
	Display type	LCD			
	Number of displays	3-screen display (Main screen, Sub screen)			
	Display color	1) Main screen: Red/Green, 2) Sub screen: Orange			
Number of display digits	1) Main screen: 5 digits (7 segments), 2) Sub screen: 9 digits (7 segments)				
Indicator LED	LED ON when switch output is ON. OUT1/2: Orange				
Digital filter*8	Select from 0.00, 0.05 to 0.1 s (increment of 0.01 s), 0.1 to 1.0 s (increment of 0.1 s), 1 to 10 s (increment of 1 s), 20 s, or 30 s.				
Environmental resistance	Enclosure	IP40			
	Withstand voltage	1000 VAC for 1 min between terminals and housing			
	Insulation resistance	50 MΩ or more (500 VDC measured via megohmmeter) between terminals and housing			
	Operating temperature range	Operating: 0 to 50°C, Stored: -10 to 60°C (No condensation or freezing)			
Standards	Operating/Stored: 35 to 85% RH (No condensation or freezing)				
Weight	CE marking (EMC directive/RoHS directive)				
	Body	25 g (Excluding the power supply/output connection lead wire)			
	Lead wire with connector	+39 g			

*1 Rated flow range of the applicable flow switch

*2 Value without digital filter (at 0.00 s)

*3 When using the accumulated value hold function, use the operating conditions to calculate the product life, and do not exceed it. The maximum access limit of the memory device is 1.5 million times. If the product is operated 24 hours per day, the product life will be as follows:

• 5 min interval: life is calculated as 5 min x 1.5 million = 7.5 million min = 14.3 years

• 2 min interval: life is calculated as 2 min x 1.5 million = 3 million min = 5.7 years

If the accumulated value external reset is repeatedly used, the product life will be shorter than the calculated life.

*4 If the flow fluctuates around the set value, be sure to keep a sufficient margin. Otherwise, chattering will occur.

*5 Setting is only possible for models with analog output.

*6 Setting is only possible for models with external input.

*7 Setting is only possible for models with the units selection function.

*8 The response time indicates when the set value is 90% in relation to the step input.

*9 The accumulated flow display is the upper 6-digit and lower 6-digit (total of 12 digits) display. When the upper digits are displayed, x 10⁶ lights up.

* Products with tiny scratches, marks, or display color or brightness variations which do not affect the performance of the product are verified as conforming products.

Internal Circuits and Wiring Examples

**-XY
-RT
-SV
NPN (2 outputs) + Copy function**

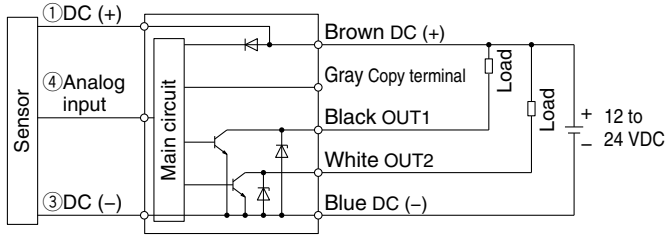

**-XY
-RT
-SV
PNP (2 outputs) + Copy function**

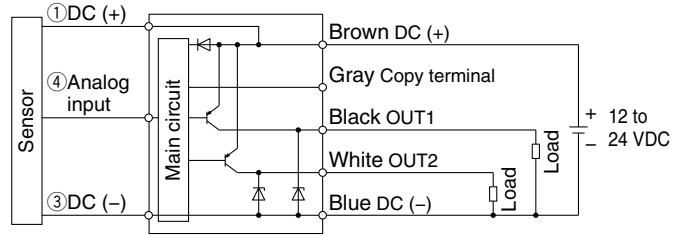

**-RT: NPN (2 outputs) + Analog voltage output
-SV: NPN (2 outputs) + Analog current output**

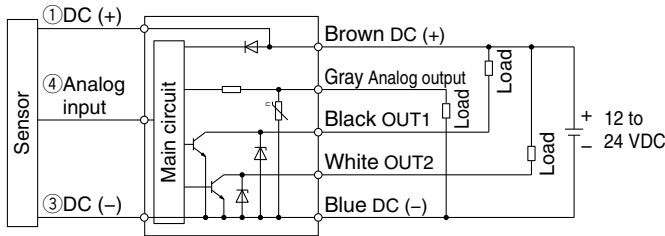

**-RT: PNP (2 outputs) + Analog voltage output
-SV: PNP (2 outputs) + Analog current output**

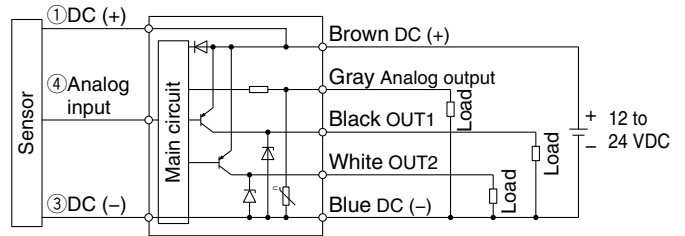

**-RT: NPN (2 outputs) + External input
-SV: NPN (2 outputs) + External input**

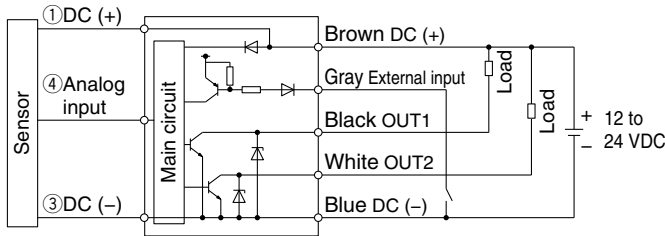

**-RT: PNP (2 outputs) + External input
-SV: PNP (2 outputs) + External input**

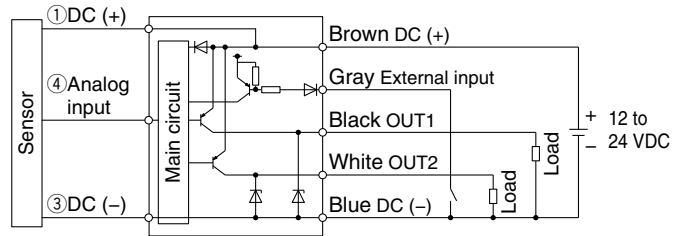

Accumulated pulse output wiring examples

NPN (2 outputs) type

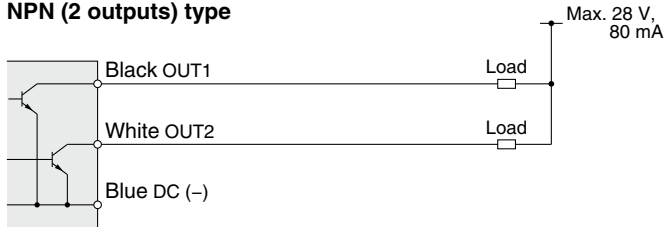

PNP (2 outputs) type

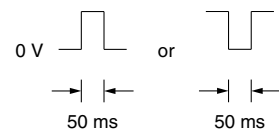
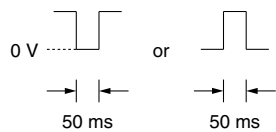
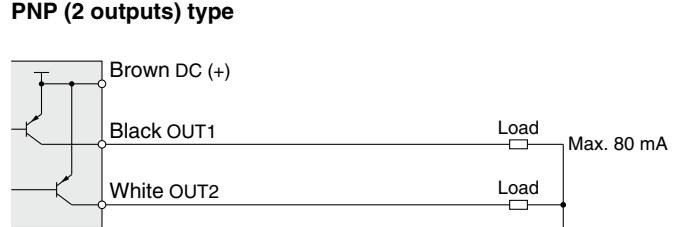

PFG300

PFG300-L

PFG300

Function Details

PFG300 Series

Dimensions

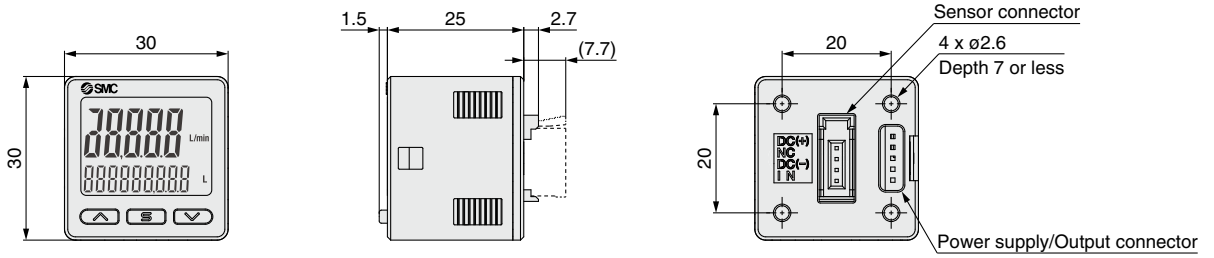

Bracket A (Part no.: ZS-46-A1)

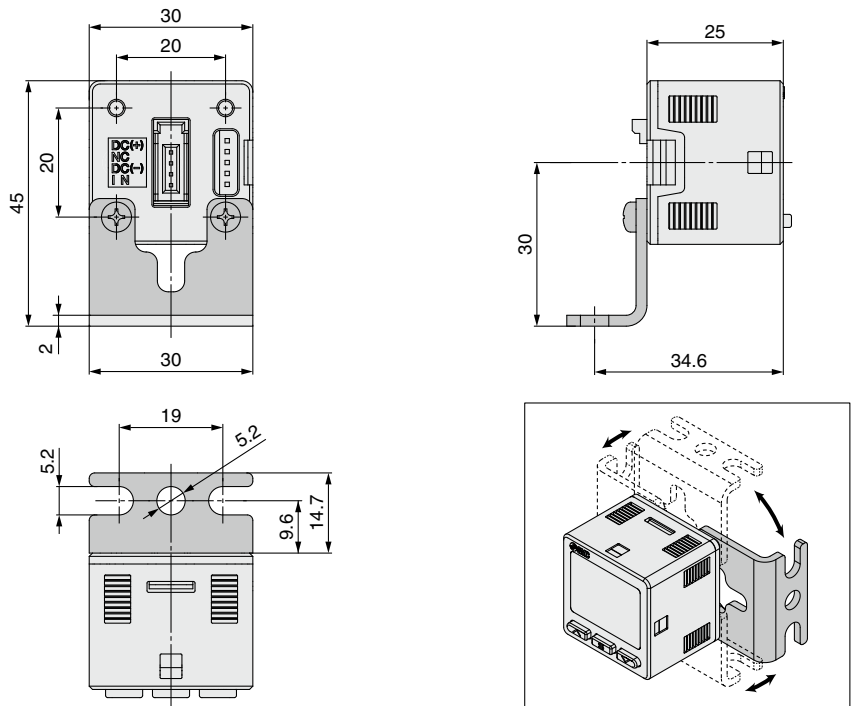

* Bracket configuration allows for mounting in four orientations.

Bracket B (Part no.: ZS-46-A2)

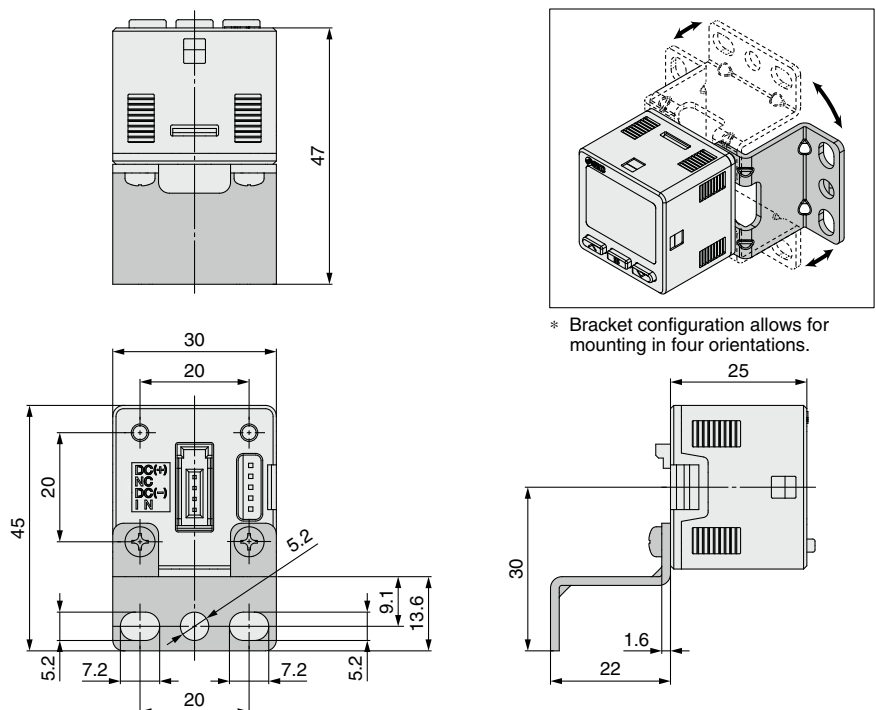

* Bracket configuration allows for mounting in four orientations.

Dimensions

Panel mount adapter (Part no.: ZS-46-B)

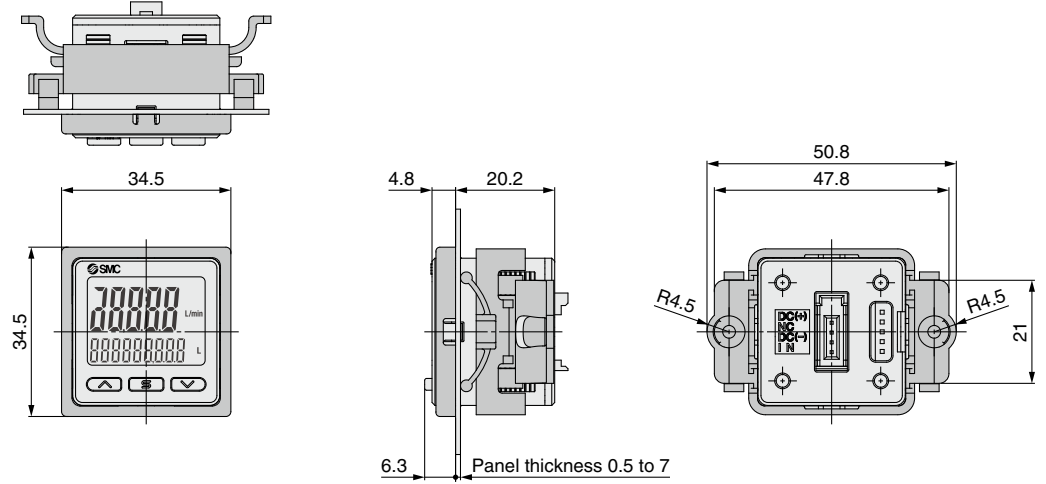

Panel mount adapter + Front protection cover (Part no.: ZS-46-D)

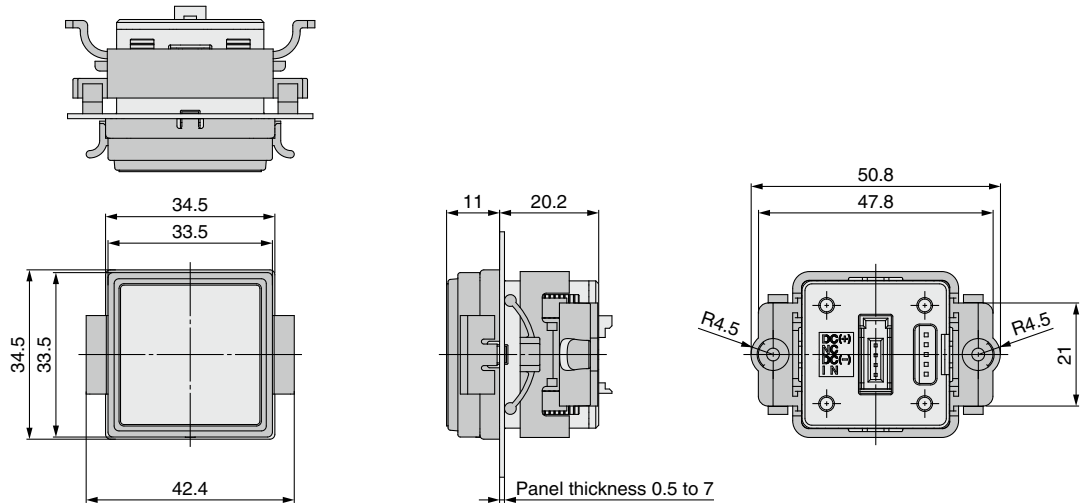

Power supply/output connection lead wire (Part no.: ZS-46-5L)

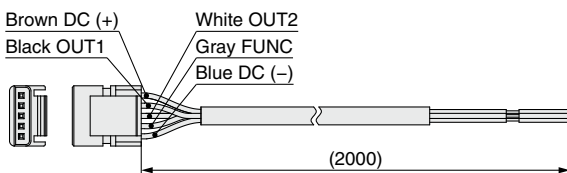

Sensor connector (Part no.: ZS-28-CA-4)

Pin no.	Terminal
1	DC (+)
2	N.C.
3	DC (-)
4	IN*1

*1 1 to 5 V or 4 to 20 mA

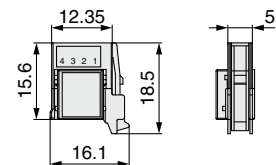

Cable Specifications

Conductor cross section	0.15 mm ² (AWG26)	
Insulator	Outside diameter	1.0 mm
	Color	Brown, Blue, Black, White, Gray (5-core)
Sheath	Finished outside diameter	ø3.5

PFG300 Series

Dimensions

Panel fitting dimensions

Individual mounting

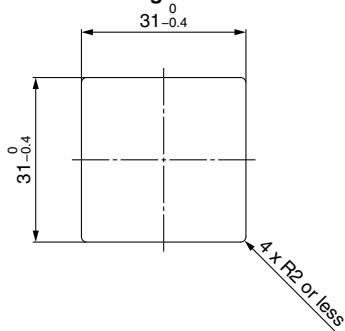

Multiple (2 pcs. or more) secure mounting <Horizontal>

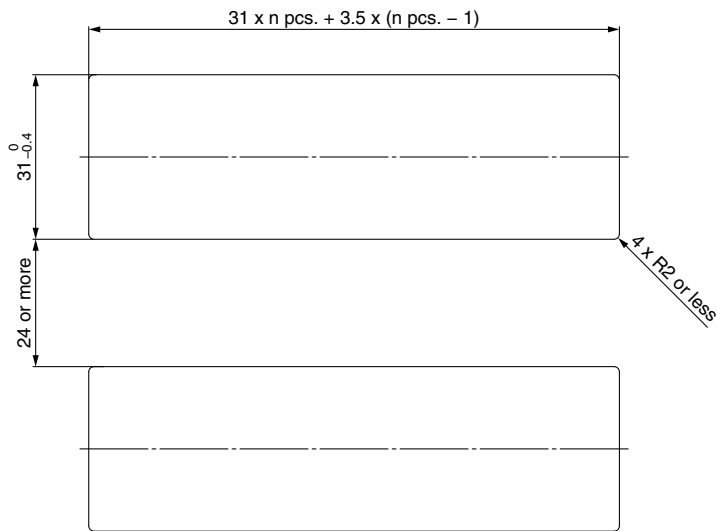

Panel mount example <Horizontal>

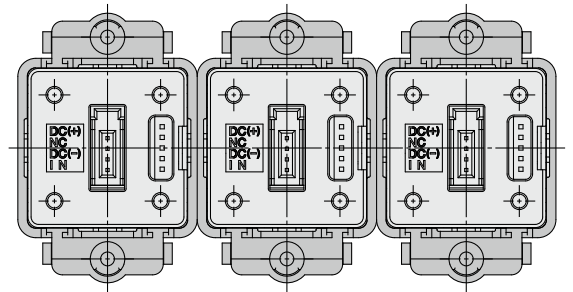

<Vertical>

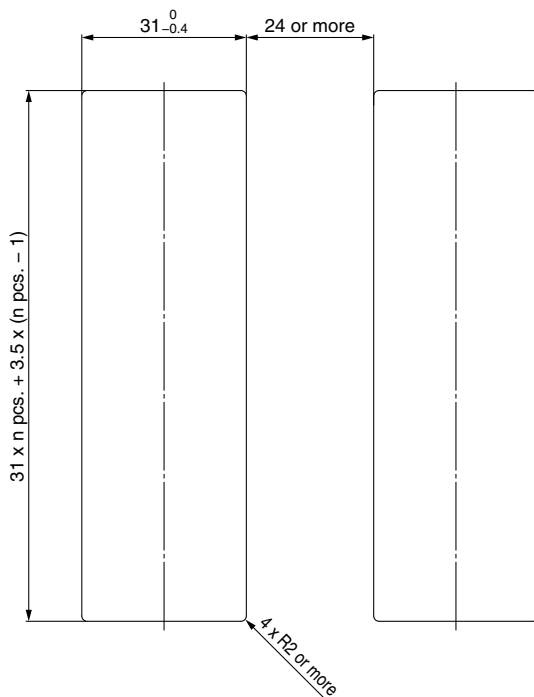

Panel mount example <Vertical>

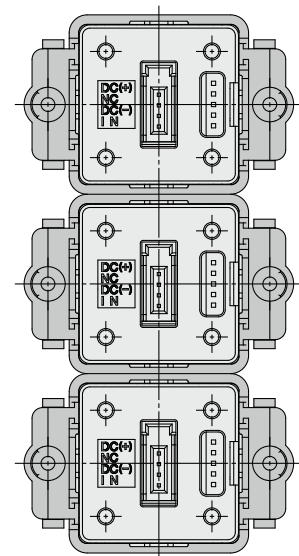

PFMC7(-L) Series Function Details

■ Delay time setting (PFMC7-L series only)

The time from when the instantaneous flow reaches the set value to when the switch output operates can be set. Setting the delay time can prevent the switch output from chattering.

The total switching time is the switch operation time and the set delay time.
(Default setting: 0 s)

0.00 s
0.05 to 0.1 s (increment of 0.01 s)
0.1 to 1.0 s (increment of 0.1 s)
1 to 10 s (increment of 1 s)
20 s
30 s
40 s
50 s
60 s

■ Output operation

The output operation can be selected from the following:
Output (hysteresis mode and window comparator mode) corresponding to instantaneous flow, output (accumulated output and pulse output) corresponding to accumulated flow, error output, or output OFF (PFMC7-L series only)

* At the time of shipment from the factory, it is set to hysteresis mode and normal output.

■ Display color

The display color can be selected for each output condition. The selection of the display color provides visual identification of abnormal values. (The display color depends on OUT1 setting.)

Green for ON, Red for OFF
Red for ON, Green for OFF
Red all the time
Green all the time

■ Reference condition

The display unit can be selected from standard condition or normal condition.

Standard condition: Flow rate converted to a volume at 20°C and 1 atm (atmosphere)
Normal condition: Flow rate converted to a volume at 0°C and 1 atm (atmosphere)

■ Display mode

The display mode can be selected from instantaneous flow or accumulated flow.

Instantaneous flow display
Accumulated flow display

■ Display

The display of the PFMC7 series and that of the PFMC7-L series differs slightly.

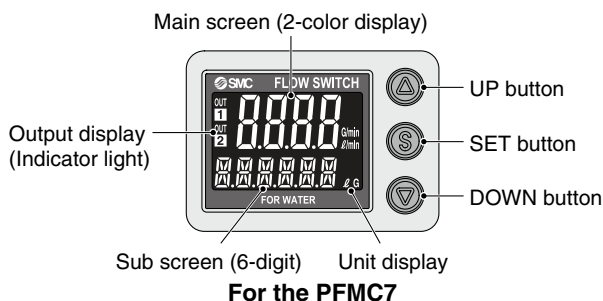

■ Response time (Digital filter)

The response time can be selected to suit the application.
(Default setting : 1 s)

Abnormalities can be detected more quickly by setting the response time to 0.05 seconds.

The effect of fluctuation and flickering of the display can be reduced by setting the response time to 2 seconds.

* 5 s can only be selected for the PFMC7-L series.

0.05 s
0.1 s
0.5 s
1 s
2 s
5 s

■ External input function

This function can be used only when the optional external input is present. The accumulated flow, peak value, and bottom value can be reset remotely.

Accumulated value external reset: A function to reset the accumulated flow value when an external input signal is applied.
In accumulated increment mode, the accumulated value will reset to and increase from zero.
In accumulated decrement mode, the accumulated value will reset to and decrease from the set value.

* When the accumulated value is stored to memory, every time the accumulated value external reset is activated, the memory (EEPROM) will be accessed. Take into consideration that the maximum number of times the memory can be accessed is 1 million times. The total number of external inputs and the accumulated value memorizing time interval should not exceed 1 million times.

Peak/Bottom value reset: Peak and bottom value are reset.

■ Forced output function

The output is turned on/off in a fixed state when starting the system or during maintenance. This enables the confirmation of wiring and prevents system errors due to unexpected output.

For the analog output type, when ON the output will be 5 V or 20 mA, and when OFF, it will be 1 V or 4 mA.

* Also, an increase or decrease of the flow and temperature will not change the on/off status of the output while the forced output function is activated.

■ Accumulated value hold

The accumulated value is not cleared even when the power supply is turned off.

The accumulated value is memorized every 2 or 5 minutes during measurement and continues from the last memorized value when the power supply is turned on again.

The life time of the memory device is 1 million access times. Take this into consideration before using this function.

■ Peak/Bottom value display

The maximum (minimum) flow rate is detected and updated from when the power supply is turned on. In peak (bottom) value display mode, this maximum (minimum) flow rate is displayed.

■ Key-lock function

Prevents operation errors such as accidentally changing setting values

■ Display OFF mode

This function will turn the display OFF. In this mode, decimal points flash on the main screen. If any button is pressed during this mode, the display reverts to normal for 30 seconds to allow checking of the flow, etc.

■ Setting of security code

The user can select whether a security code must be entered to release the key lock. At the time of shipment from the factory, it is set such that a security code is not required.

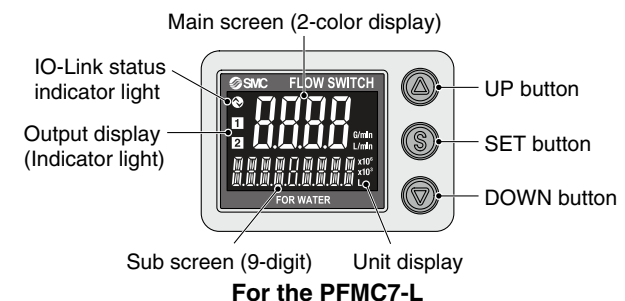

PFMC7(-L) Series

■ Analog output free range function

This function allows a flow that generates an output of 5 V (or 10 V when 0 to 10 V is selected) or 20 mA to be changed.
The value can be changed between 10% of the maximum value of the rated flow and the maximum value of the display range.

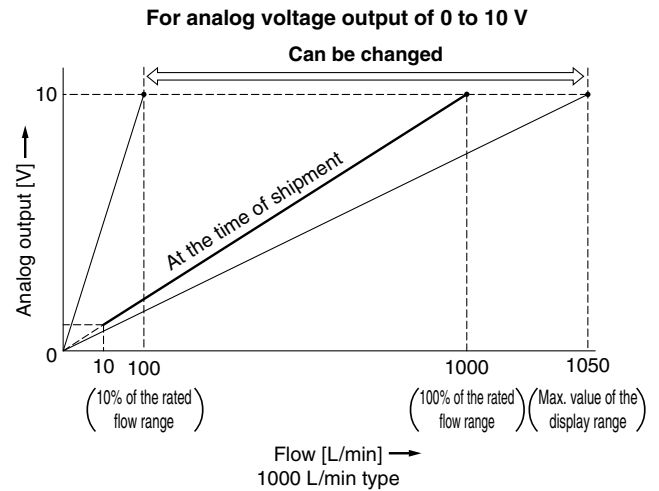
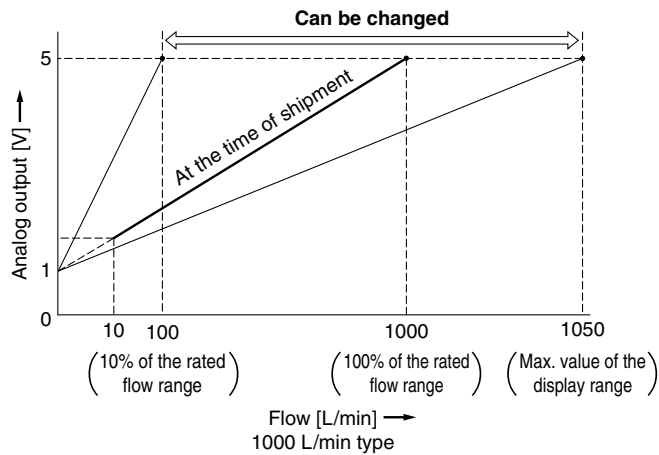

■ Error display function

When an error or abnormality arises, the location and contents are displayed.

Display	Error name	Description	Action	Applicable model			
				PFMC7 series	PFMC7-L series		
Er1	OUT1 over current error	A load current of 80 mA or more is applied to the switch output (OUT1).	Eliminate the cause of the over current by turning off the power supply and then turning it on again.	●	●		
Er2	OUT2 over current error	A load current of 80 mA or more is applied to the switch output (OUT2).		●	●		
HHH	Instantaneous flow error	The flow has exceeded the upper limit of the flow display range.	Decrease the flow rate.	●	●		
LLL	Reverse flow error	There is a reverse flow equivalent to -5% or more.	Change the flow to the correct direction.	●	●		
999999999 (Alternately displays [999] and [999999])	Accumulated flow error	The accumulated flow has exceeded the accumulated flow range.	Reset the accumulated flow.	●	—		
999999 (Flashing) x 10 ⁶	Accumulated flow error	The accumulated flow has exceeded the accumulated flow range.	Reset the accumulated flow.	—	●		
Er0 Er4 Er6 Er8	System error	An internal data error has occurred.	Turn the power OFF and turn it ON again.	●	●		
Er16 Er40				—	●		
Er3				Outside of zero-clear range	During zero-clear operation, the flow rate of ±5% F.S. or more is applied. (The mode is returned to measurement mode after 1 second.)	—	●
Er15				Version does not match	The IO-Link version does not match that of the master.	—	●

If the error cannot be solved after the instructions above are performed, please contact SMC for investigation.

PFG300 Series

Function Details

Output operation

The output operation can be selected from the following:
Output (hysteresis mode and window comparator mode) corresponding to instantaneous flow or output (accumulated output and pulse output) corresponding to accumulated flow.

(Default setting: Hysteresis mode, Normal output)

Simple setting mode

Only the set values for instantaneous flow and accumulated flow can be changed. Output mode, output type, display color, and accumulate pulse output cannot be changed.

Display color

The display color can be selected for each output condition. The selection of the display color provides visual identification of abnormal values.

Green for ON, Red for OFF
Red for ON, Green for OFF
Red all the time
Green all the time

Delay time setting

The time from when the instantaneous flow reaches the set value to when the switch output operates can be set. Setting the delay time can prevent the switch output from chattering.

(Default setting: 0 s)

0.00 s
0.05 to 0.1 s (increment of 0.01 s)
0.1 to 1.0 s (increment of 0.1 s)
1 to 10 s (increment of 1 s)
20 s
30 s
40 s
50 s
60 s

Digital filter setting

The time for the digital filter can be set to the sensor input. Setting the digital filter can reduce chattering of the switch output and flickering of the analog output and the display.

The response time indicates when the set value is 90% in relation to the step input.

(Default setting: 0 s)

0.00 s
0.05 to 0.1 s (increment of 0.01 s)
0.1 to 1.0 s (increment of 0.1 s)
1 to 10 s (increment of 1 s)
20 s
30 s

FUNC output switching function

Analog output, external input, or copy function can be selected.
(Default setting: Analog output)

Selectable analog output function

1 to 5 V or 0 to 10 V can be selected for the analog voltage output type.
(Default setting: 1 to 5 V)

External input function

The accumulated flow, peak value, and bottom value can be reset remotely.

Accumulated value external reset: A function to reset the accumulated flow value when an external input signal is applied.

In accumulated increment mode, the accumulated value will reset to and increase from zero.

In accumulated decrement mode, the accumulated value will reset to and decrease from the set value.

* When the accumulated value is stored to memory, every time the accumulated value external reset is activated, the memory will be accessed. Take into consideration that the maximum number of times the memory can be accessed is 1.5 million times. The total number of external inputs and the accumulated value memorizing time interval should not exceed 1.5 million times.

Peak/Bottom value reset: Peak and bottom value are reset.

Forced output function

The output is turned on/off in a fixed state when starting the system or during maintenance. This enables the confirmation of wiring and prevents system errors due to unexpected output.

For the analog output type: When ON, the output will be 5 V (or 10 V when 0 to 10 V is selected) or 20 mA, and when OFF, 1 V (or 0 V when 0 to 10 V is selected) or 4 mA.

* Also, an increase or decrease of the flow will not change the on/off status of the output while the forced output function is activated.

Accumulated value hold

The accumulated value is not cleared even when the power supply is turned off. The accumulated value is memorized every 2 or 5 minutes during measurement and continues from the last memorized value when the power supply is turned on again.

The maximum writable limit of the memory device is 1.5 million times, which should be taken into consideration.

Peak/Bottom value display

The maximum (minimum) flow rate is detected and updated from when the power supply is turned on. In peak (bottom) value display mode, this maximum (minimum) flow rate is displayed.

Setting of security code

The user can select whether a security code must be entered to release the key lock. At the time of shipment from the factory, it is set such that a security code is not required.

Key-lock function

Prevents operation errors such as accidentally changing setting values

Reset to the default settings

The product can be returned to its factory default settings.

Display with zero cut-off setting

When the flow is close to 0 L/min, the product will round the value down and zero will be displayed. A flow value may be displayed even when the flow rate is 0 L/min due to high pressure or depending on the installation. The zero-cut function will force the display to zero. The range to display zero can be changed.

PFG300

PFG300-L

PFG300

Function Details

PFG300 Series

■ Selection of display on sub screen

The display on the sub screen in measuring mode can be set.

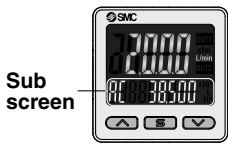

Set value display	Accumulated value display	Peak value display
Displays the set value 	Displays the accumulated value 	Displays the peak value
Bottom value display	Line name display	OFF
Displays the bottom value 	Displays the line name (Up to 5 alphanumeric characters can be input.) 	Displays nothing

■ Analog output free range function

This function allows a flow that generates an output of 5 V (or 10 V when 0 to 10 V is selected) or 20 mA to be changed. The value can be changed between 10% of the maximum value of the rated flow and the maximum value of the display range.

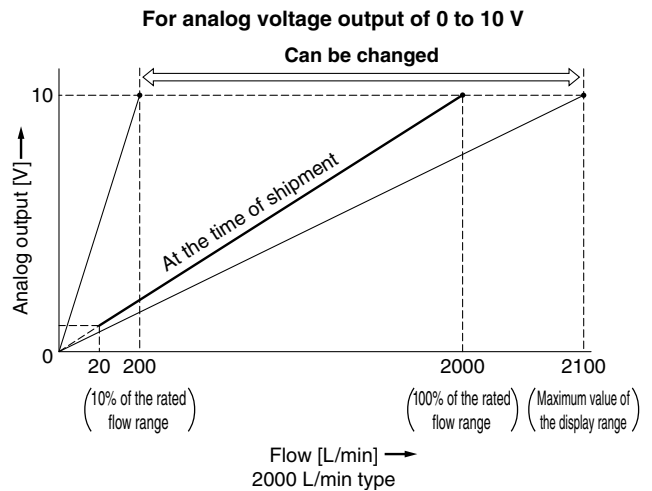
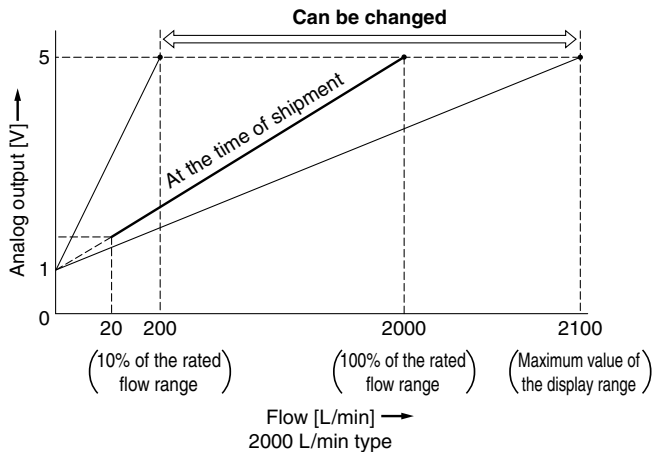

■ Error display function

When an error or abnormality arises, the location and contents are displayed.

Display	Description	Contents	Action
Er1 Er2	OUT over current error	A load current of 80 mA or more is applied to the switch output (OUT).	Eliminate the cause of the over current by turning off the power supply and then turning it on again.
HHH	Instantaneous flow error	The flow rate exceeds the maximum value of the display range.	Decrease the flow rate.
LLL	Reverse flow error	There is a reverse flow equivalent to -5% or more.	Change the flow to the correct direction.
999999 flashes x 10 ⁶	Accumulated flow error	The flow rate exceeds the accumulated flow rate range.	Clear the accumulated flow rate.
Er0 Er4 Er6 Er7 Er8 Er14 Er40	System error	An internal error has occurred.	Turn the power off and then on again.
Er13	Copy error	The copy function does not operate properly.	After clearing the error by pressing the and buttons simultaneously for a minimum of 1 second, check the wiring and the model, and then attempt to copy again.

If the error cannot be solved after the instructions above are performed, please contact SMC for investigation.

■ **Copy function**

The set values of the monitor can be copied.

This can reduce setting labor and minimize the risk of setting mistakes.

The set value can be copied to up to 10 flow monitors simultaneously.

(Maximum transmission distance: 4 m)

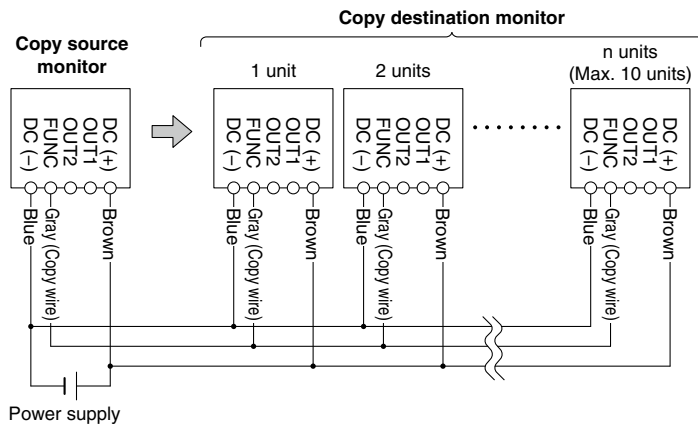
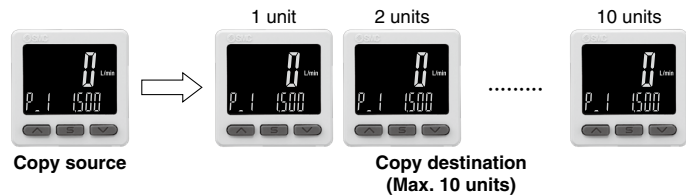

- 1) Wire as shown in the figure on the left.
- 2) All monitors are set to copy destination when first purchased. (Default condition is the monitor to be copied to.)
- 3) Press the **S** button on the source monitor to start copying.

■ **Selection of power saving mode**

The power saving mode can be selected.

With this function, if no buttons are pressed for 30 s, it shifts to power saving mode.

At the time of shipment from the factory, the product is set to the normal mode (the power saving mode is turned off).

(During power saving mode, [ECo] will flash in the sub screen and the operation light will be ON (only when the switch is ON).)

* There may be a difference in the displayed value on the connected flow switch and the flow monitor. When the flow monitor display is being used, it is recommended to set the flow switch display to OFF mode.

P F M C 7

P F M C 7 - L

P F G 3 0 0

Function
Details

Safety Instructions

These safety instructions are intended to prevent hazardous situations and/or equipment damage. These instructions indicate the level of potential hazard with the labels of “**Caution**,” “**Warning**” or “**Danger**.” They are all important notes for safety and must be followed in addition to International Standards (ISO/IEC)*1), and other safety regulations.

 **Caution:** **Caution** indicates a hazard with a low level of risk which, if not avoided, could result in minor or moderate injury.

 **Warning:** **Warning** indicates a hazard with a medium level of risk which, if not avoided, could result in death or serious injury.

 **Danger :** **Danger** indicates a hazard with a high level of risk which, if not avoided, will result in death or serious injury.

*1) ISO 4414: Pneumatic fluid power – General rules relating to systems.
ISO 4413: Hydraulic fluid power – General rules relating to systems.
IEC 60204-1: Safety of machinery – Electrical equipment of machines.
(Part 1: General requirements)
ISO 10218-1: Manipulating industrial robots – Safety.
etc.

Warning

1. The compatibility of the product is the responsibility of the person who designs the equipment or decides its specifications.

Since the product specified here is used under various operating conditions, its compatibility with specific equipment must be decided by the person who designs the equipment or decides its specifications based on necessary analysis and test results. The expected performance and safety assurance of the equipment will be the responsibility of the person who has determined its compatibility with the product. This person should also continuously review all specifications of the product referring to its latest catalog information, with a view to giving due consideration to any possibility of equipment failure when configuring the equipment.

2. Only personnel with appropriate training should operate machinery and equipment.

The product specified here may become unsafe if handled incorrectly. The assembly, operation and maintenance of machines or equipment including our products must be performed by an operator who is appropriately trained and experienced.

3. Do not service or attempt to remove product and machinery/equipment until safety is confirmed.

1. The inspection and maintenance of machinery/equipment should only be performed after measures to prevent falling or runaway of the driven objects have been confirmed.
2. When the product is to be removed, confirm that the safety measures as mentioned above are implemented and the power from any appropriate source is cut, and read and understand the specific product precautions of all relevant products carefully.
3. Before machinery/equipment is restarted, take measures to prevent unexpected operation and malfunction.

4. Contact SMC beforehand and take special consideration of safety measures if the product is to be used in any of the following conditions.

1. Conditions and environments outside of the given specifications, or use outdoors or in a place exposed to direct sunlight.
2. Installation on equipment in conjunction with atomic energy, railways, air navigation, space, shipping, vehicles, military, medical treatment, combustion and recreation, or equipment in contact with food and beverages, emergency stop circuits, clutch and brake circuits in press applications, safety equipment or other applications unsuitable for the standard specifications described in the product catalog.
3. An application which could have negative effects on people, property, or animals requiring special safety analysis.
4. Use in an interlock circuit, which requires the provision of double interlock for possible failure by using a mechanical protective function, and periodical checks to confirm proper operation.

Caution

1. The product is provided for use in manufacturing industries.

The product herein described is basically provided for peaceful use in manufacturing industries.
If considering using the product in other industries, consult SMC beforehand and exchange specifications or a contract if necessary.
If anything is unclear, contact your nearest sales branch.

Limited warranty and Disclaimer/ Compliance Requirements

The product used is subject to the following “Limited warranty and Disclaimer” and “Compliance Requirements”.

Read and accept them before using the product.

Limited warranty and Disclaimer

1. The warranty period of the product is 1 year in service or 1.5 years after the product is delivered, whichever is first.*2)
Also, the product may have specified durability, running distance or replacement parts. Please consult your nearest sales branch.
2. For any failure or damage reported within the warranty period which is clearly our responsibility, a replacement product or necessary parts will be provided.
This limited warranty applies only to our product independently, and not to any other damage incurred due to the failure of the product.
3. Prior to using SMC products, please read and understand the warranty terms and disclaimers noted in the specified catalog for the particular products.

*2) Vacuum pads are excluded from this 1 year warranty.

A vacuum pad is a consumable part, so it is warranted for a year after it is delivered.
Also, even within the warranty period, the wear of a product due to the use of the vacuum pad or failure due to the deterioration of rubber material are not covered by the limited warranty.

Compliance Requirements

1. The use of SMC products with production equipment for the manufacture of weapons of mass destruction (WMD) or any other weapon is strictly prohibited.
2. The exports of SMC products or technology from one country to another are governed by the relevant security laws and regulations of the countries involved in the transaction. Prior to the shipment of a SMC product to another country, assure that all local rules governing that export are known and followed.

Caution

SMC products are not intended for use as instruments for legal metrology.

Measurement instruments that SMC manufactures or sells have not been qualified by type approval tests relevant to the metrology (measurement) laws of each country. Therefore, SMC products cannot be used for business or certification ordained by the metrology (measurement) laws of each country.

Revision History

Edition B	* The digital flow monitor PFG300 series has been added. * Number of pages has been increased from 16 to 28.	VU
Edition C	* IO-Link compatible products (PFMC7-L) have been added. * Number of pages has been increased from 28 to 32.	ZP

Safety Instructions

Be sure to read the “Handling Precautions for SMC Products” (M-E03-3) and “Operation Manual” before use.