

# 3-Screen Display

# High-Precision Digital Pressure Switch

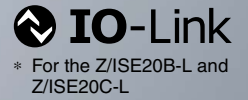

**New** An M12 connector type has been added to the 20B series. [p. 13-1](#)



**New** A low pressure range type has been added to the 20A series.

Made to Order [p. 6](#)



It is possible to change the settings

**Main screen** Measured value (Current pressure value)

while checking the measured value.

**Sub screen** Label (Display item), Set value (Threshold value)



Visualization of settings

Set value (Threshold value)	P-1	Peak value	H-H	Hysteresis value	H-L
Bottom value	H-L0	Delay time	dt1		

Applicable fluid	Series	Output type	Enclosure	Copy function	Piping			
					M5 female thread	1/8 (R, NPT)	One-touch fittings (ø4 mm, ø6 mm, ø1/4 inch)	1/4 (R, NPT, G) (URJ*1/TSJ*2)
Air	ZSE20(F)/ISE20 <a href="#">p. 9</a>	1 output	IP40	—	●	●	●	—
	ZSE20A(F)/ISE20A <a href="#">p. 11</a>	2 outputs Analog output (Voltage/Current)	IP40	●	●	●	●	—
	ZSE20B(F)-(L)/ISE20B-(L) <a href="#">pp. 13, 15</a>	2 outputs Analog output (Voltage/Current)  IO-Link/ Switch: 1 output	IP65	● —*4	●	●	●*5 —	—
General fluids	ZSE20C(F)-(L)/ISE20C(H)-(L) <a href="#">pp. 25, 27</a>	2 outputs Analog output (Voltage/Current)  IO-Link/ Switch: 1 output	IP65	● —*4	●*3	● (Rc thread only)	—	●

\*1 Face seal fitting \*2 Compression fitting \*3 With 1/4 (R, NPT, G) M5 female threaded \*4 A block parameter or data storage function is provided with the IO-Link compatible type. \*5 Only the ø4 mm or ø6 mm elbow type One-touch fitting is applicable.

## ZSE20□(F)/ISE20□ Series



CAT.ES100-114E (A)

# Improved Operability

## Visualization of Settings

The sub screen (label) shows the item to be set.

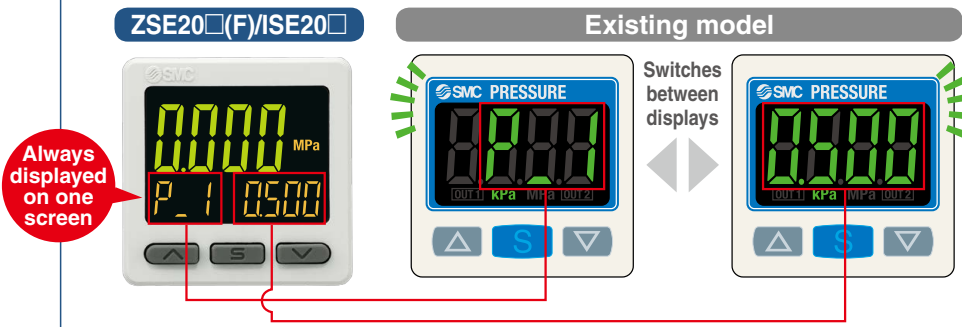

### Mode Examples

Hysteresis mode			
Normal output	Set value (Threshold value)	Reversed output	Set value (Threshold value)
P_1	0500	n_1	0500
Hysteresis	Set hysteresis value		
H_1	0050		

Window comparator mode			
Normal output/Lo side	Set value (Threshold value)	Normal output/Hi side	Set value (Threshold value)
P_L	0300	P_H	0500
Reversed output/Lo side	Set value (Threshold value)	Reversed output/Hi side	Set value (Threshold value)
n_L	0300	n_H	0500

## Simple 3-Step Setting

When the S button is pressed and the set value (P\_1) is being displayed, the set value (threshold value) can be set. When the S button is pressed and the hysteresis (H\_1) is being displayed, the hysteresis value can be set.

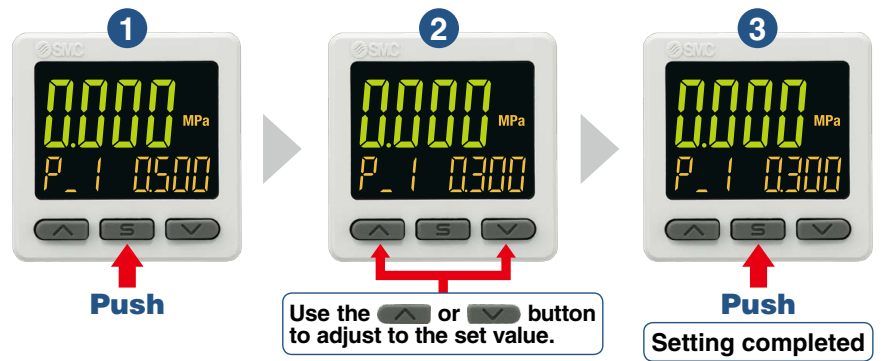

## Now with a snap shot function for set value reading

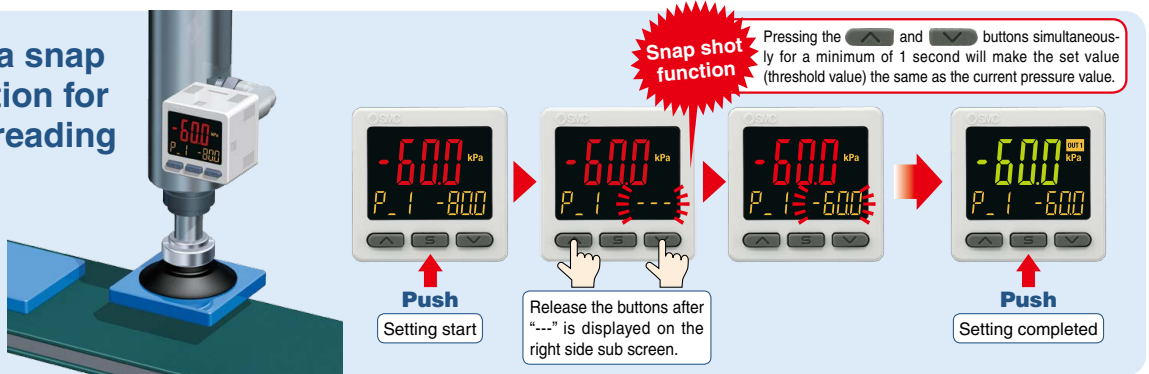

## Easy Screen Switching

It is possible to change the settings while checking the measured value.

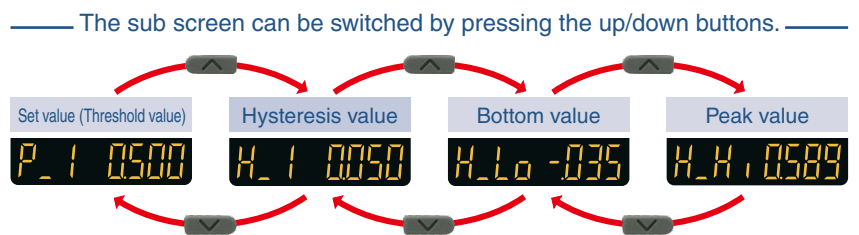
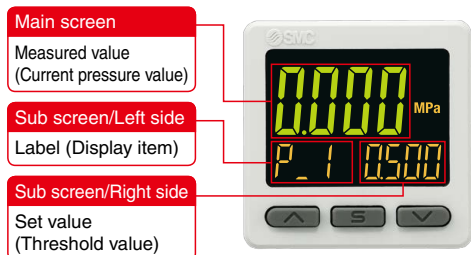

\* One additional arbitrary display mode can be added via the function settings. (Refer to page 3.)  
 \* Example for 1 output

### 3 Setting Modes Select the setting mode that best meets your needs.

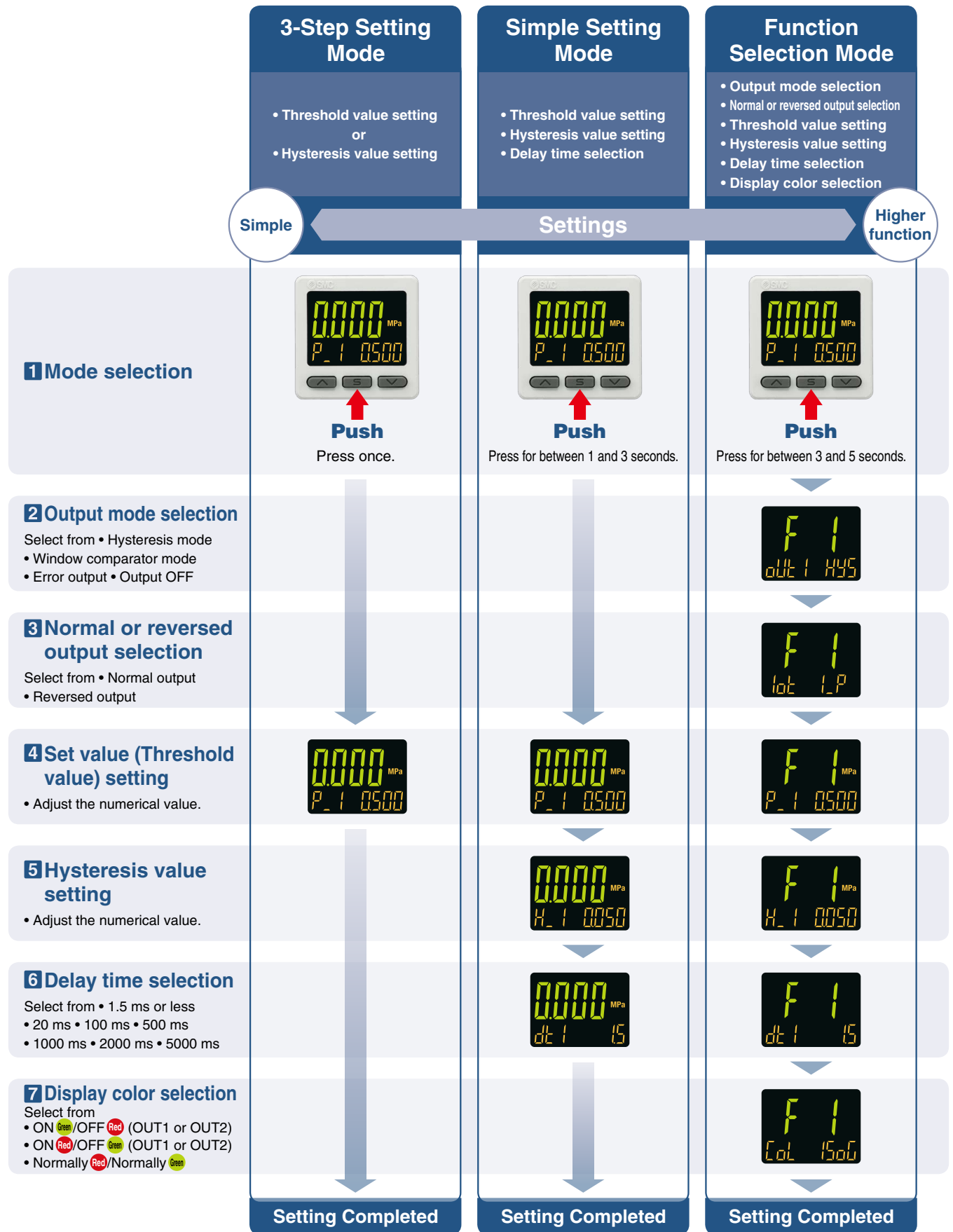

\* For 1 output

# Improved Operability

## Other Sub Screen Display

The peak value or bottom value, or both values can be displayed on one screen!

\* Peak and bottom values are maintained even if the power supply is cut.

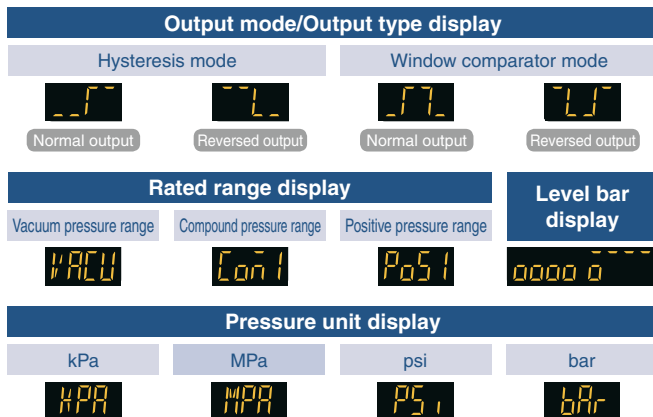
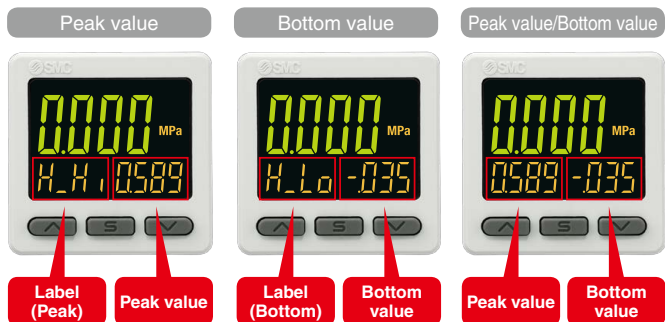

\* A combination of the displays shown above and the set values can be displayed on the 2 sub screens.

# Delay Time 1.5 ms\*1 or less

\*1 Select from 1.5 ms or less, 20 ms, 100 ms, 500 ms, 1000 ms, 2000 ms, or 5000 ms.

# Convenient Functions

pp. 17, 29

Functions	Copy function	Auto-shift function	Security code	Power saving mode	Resolution switch function	MPa/kPa switch function
20	—	—	●	●	●	●
20A	●	●	●	●	●	●
20B	●	●	●	●	●	●
20B-L	—	—	●	●	●	●
20C	●	●	●	●	●	●
20C-L	—	—	●	●	●	●

### ● Copy function

The set values of the sensor can be copied.



### ● Auto-shift function

This measures the pressure at the time of external input and uses it as a reference to correct the on-off point of the switch.

### ● Security code

The key-lock function keeps unauthorized persons from tampering with the settings.

### ● Power saving mode

Power consumption is reduced by turning off the monitor.

Series	Current consumption	Reduction rate*1
20	25 mA or less	Approx. 60% reduction
20A		
20B(-L)	35 mA or less	Approx. 40% reduction
20C(-L)		

\*1 In power saving mode

### ● Display resolution switch function

Reduces monitor flickering

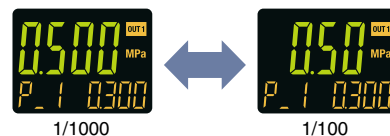

(Only the displayed values are changed; the accuracy remains the same.)

### ● MPa/kPa switch function

Vacuum, compound, and/or positive pressure can be displayed in MPa or kPa.



## Compact & Lightweight

- **Compact: Max. 17.5 mm shorter**  
(When an M5 female thread is used.)

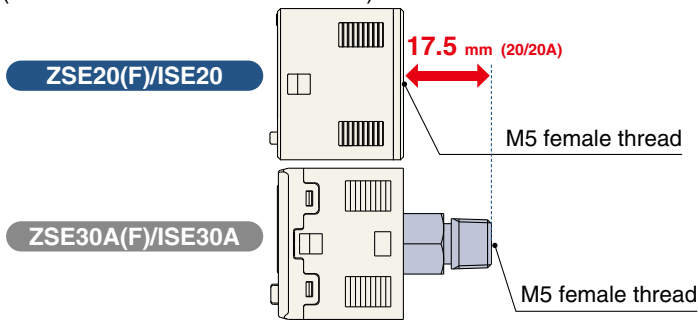

- **Lightweight: Max. 21 g lighter**  
(When an M5 female thread is used.)

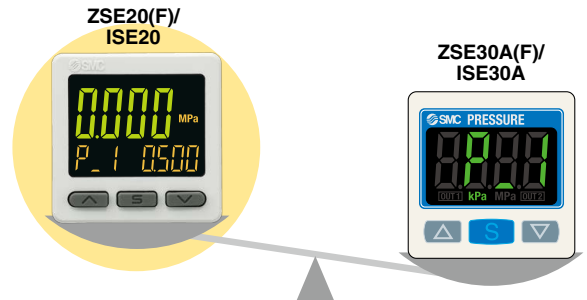

## Improved Installability

### Connector type

Wiring is possible after piping has been connected

**New**

M12 connector type  
p. 13-1

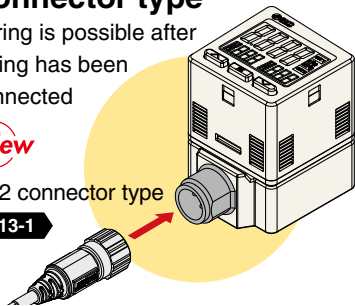

Lead wire with connector type

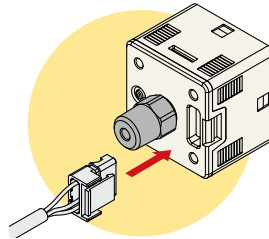

Grommet type  
ZSE/ISE40, 80 series



## Enclosure

### Connector structure

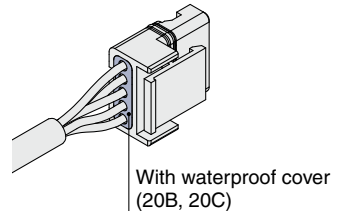

### Enclosure Ratings

Series	IP40	IP65
20	●	—
20A	●	—
20B(-L)	—	●
20C(-L)	—	●

## Mounting

### Available Mounting Options

Series	Bracket A	Bracket B	Bracket C	Panel mount
20	●	●	—	●
20A	●	●	—	●
20B(-L)	●	●	—	●
20C(-L)	●	—	●	●

The bracket configuration allows for mounting in four orientations.

### Bracket A

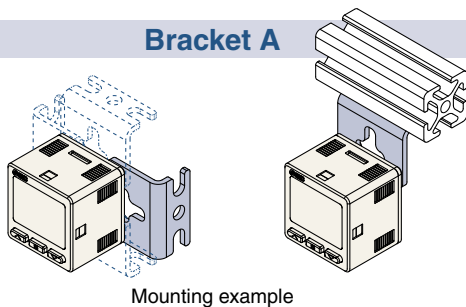

### Bracket B

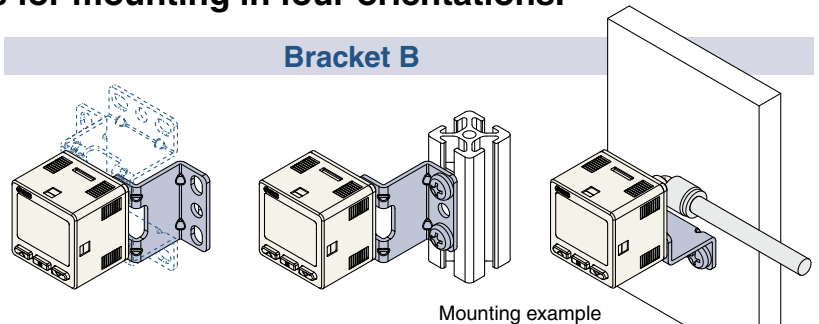

### Bracket C

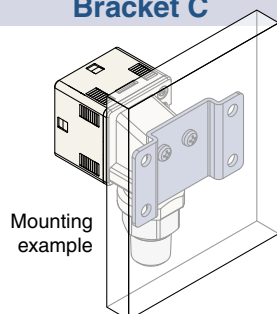

### Panel mount

Mountable side by side both vertically and horizontally

### One opening!

- Reduced panel fitting labor
- Space saving

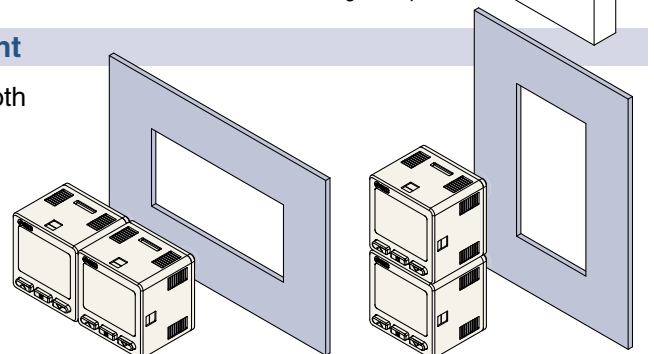

**IO-Link Compatible** ZSE20B(F)-L/ISE20B-L, ZSE20C(F)-L/ISE20C(H)-L pp. 15, 27

**Visualization of operation/equipment status/Remote monitoring and control by communication**

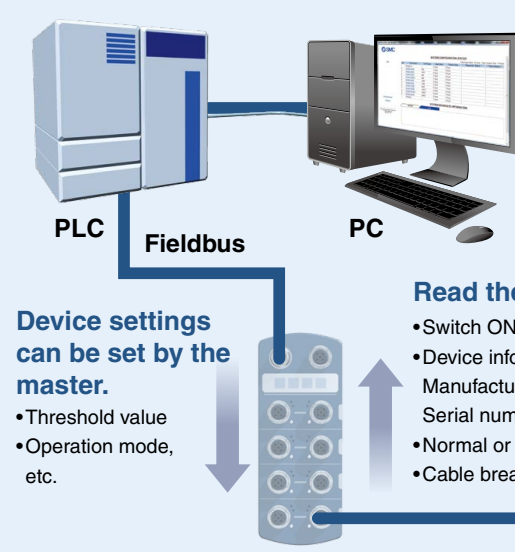

**Configuration File (IODD File\*1)**  
 •Manufacturer •Product part no. •Set value

**\*1 IODD File:**  
 IODD is an abbreviation of IO Device Description. This file is necessary for setting the device and connecting it to a master. Save the IODD file on the PC to be used to set the device prior to use.

**IO-Link**

IO-Link is an open communication interface technology between the sensor/actuator and the I/O terminal that is an international standard: IEC 61131-9.



IO-Link Compatible Device  
 ZSE20B(F)-L/ISE20B-L  
 ZSE20C(F)-L/ISE20C(H)-L

**Device settings can be set by the master.**

- Threshold value
- Operation mode, etc.

**Read the device data.**

- Switch ON/OFF signal and analog value
- Device information: Manufacturer, Product part number, Serial number, etc.
- Normal or abnormal device status
- Cable breakage

**Implement diagnostic bits in the process data.**

The diagnostic bit in the cyclic process data makes it easy to find problems with the equipment. It is possible to find problems with the equipment in real time using the cyclic (periodic) data and to monitor such problems in detail with the noncyclic (aperiodic) data.

**Process Data**

Bit offset	Item	Note
0	OUT1 output	0: OFF 1: ON
1	OUT2 output	0: OFF 1: ON
2	Diagnosis	0: Normal 1: Abnormal
3 to 15	Measured pressure value	Unsigned 13 bit

Diagnosis items	
·	Internal product malfunction
·	Outside of zero-clear range
·	Outside of rated pressure range
·	Upper temperature limit exceeded inside the product

Bit offset	15	14	13	12	11	10	9	8	7	6	5	4	3	2	1	0
Item	Measured pressure value													Diagnosis	OUT2	OUT1

**Display function**

Displays the output communication status and indicates the presence of communication data

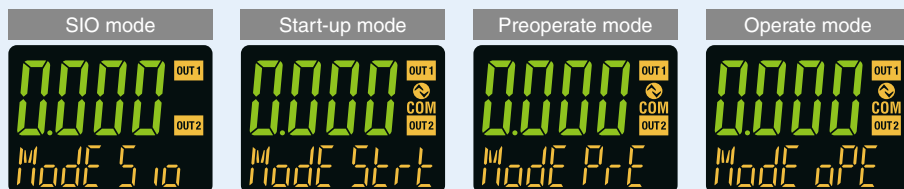

**Operation and Display**

Communication with master	IO-Link status indicator light	Status	Screen display*3	Description	
Yes	COM*1	IO-Link mode	Operate	Mode oPE	Normal communication status (readout of measured value)  At the start of communication
			Start up	Mode Start	
			Preoperate	Mode Pr-E	
		Abnormal	Version does not match	Er 15 V 1.0	The IO-Link version does not match that of the master. The master uses version 1.0. * The applicable IO-Link version is 1.1.
Lock	Mode LoE		Backup and restore required due to data storage lock		
No	OFF	Communication disconnection	Mode oPE	Normal communication was not received for 1 s or longer.	
			Mode Start		
		SIO mode	Mode S io	General switch output	

\*1 The COM indicator is ON when communication with the master is established. \*2 In IO-Link mode, the IO-Link indicator will be ON or flashing. \*3 When the sub screen is set to Mode



**Pressure Switch (for Low Pressure) ZSE20AF-X576 to 580 Made to Order p. 47**

**Able to detect and display pressures of 10 kPa or less**

Model	-X576	-X577	-X578	-X579	-X580
Rated pressure range	 -500 to 500 Pa	 -1.000 to 1.000 kPa	 -2.00 to 2.00 kPa	 -5.00 to 5.00 kPa	 -10.00 to 10.00 kPa

**With zero-cut function**

When the pressure display value is close to zero, this function forces the display to zero.  
The range within which to display zero can be changed in 0.1% increments as long as it is within 0.0% to 10.0% of the atmospheric pressure and the upper limit of the rated pressure range.

Zero-cut function (When set to 1%)  
-500 Pa → ... → -5 → 0 → 5 → ... → 500 Pa

**Applications**

Flow control

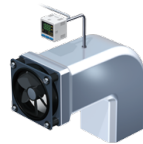

Can control air flow by monitoring the flow rate inside the duct

Liquid level detection

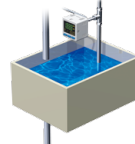

Can detect the liquid level through changes in the purge pressure

**Liquid Level Detection Range (for water)**

Pressure range	Liquid level detection range	Min. set value
±500 Pa	50 mm	0.1 mm
±1 kPa	100 mm	0.1 mm
±2 kPa	200 mm	1 mm
±5 kPa	500 mm	1 mm
±10 kPa	1000 mm	1 mm

**For General Fluids ZSE20C(F)/ISE20C(H) p. 25**



**Stainless diaphragm**

Oil-free (Single-layer diaphragm structure)

Sensor unit: **Stainless steel 630**

Fitting parts: **Stainless steel 304**

A stainless steel 316L option is also available for the sensor unit and fitting parts.

**Enclosure: IP65**

**Leakage**

$1 \times 10^{-10} \text{ Pa}\cdot\text{m}^3/\text{s}$

<Face seal and compression fitting>

$1 \times 10^{-5} \text{ Pa}\cdot\text{m}^3/\text{s}$

<Threaded type (R, Rc, NPT, G)>

**Select from 2 piping directions.**

Rear ported

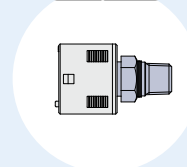

Bottom ported

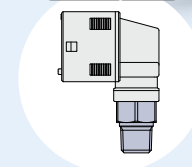

**Welded structure for sensor units and fitting parts**

Select from a face seal or compression fitting.

Face seal



Compression



Confirmation of the atmospheric pressure of a load lock chamber

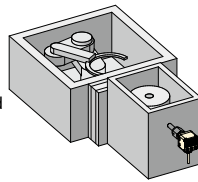

**Applicable Fluid Examples**

- Water
- Hydraulic fluid (JIS-K2213)
- Silicone oil
- Lubricant
- Fluorocarbon
- Argon
- Carbon dioxide
- Air-containing drainage
- Nitrogen

**Made to Order p. 42**

- Parts in contact with fluid: Stainless steel 316L (-X500)  
This pressure switch has increased corrosion resistance due to the use of stainless steel 316L for the parts in contact with fluid (pressure sensor and fitting).



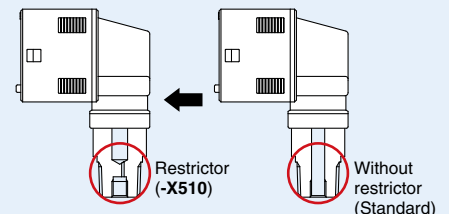



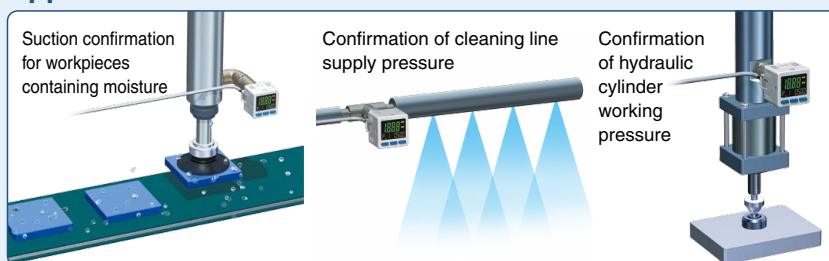

- Restrictor-installed fitting (-X510)  
A pressure switch that has a restrictor installed in the fitting is available to prevent the sensor from being damaged by water hammer or fluid inertia.



**Applications**

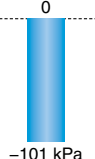
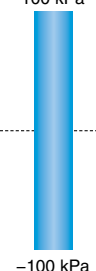
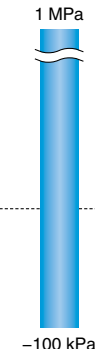
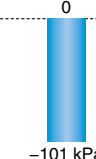
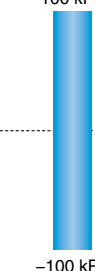

## Introduction of Series

	1 Output IP40 ZSE20(F)/ISE20 p. 9			2 Outputs IP40 ZSE20A(F)/ISE20A p. 11		
Applicable fluid	 Air					
Model	For vacuum pressure  <b>ZSE20</b>	For compound pressure  <b>ZSE20F</b>	For positive pressure  <b>ISE20</b>	For vacuum pressure  <b>ZSE20A</b>	For compound pressure  <b>ZSE20AF</b>	For positive pressure  <b>ISE20A</b>
Rated pressure range	 -101 kPa	 -100 kPa	 -100 kPa	 -101 kPa	 -100 kPa	 -100 kPa
Withstand pressure	500 kPa	500 kPa	1.5 MPa	500 kPa	500 kPa	1.5 MPa
Output specification	1 output (NPN/PNP)			2 outputs (NPN/PNP)		
Enclosure	IP40			IP40		
Piping	M5 female thread, R1/8, NPT1/8 ø4 mm One-touch fitting ø6 mm One-touch fitting ø1/4 inch One-touch fitting					
Function	—			Copy function, Auto-shift function		
Made to order pp. 42 to 48	Grease-free Lead wire with connector (Terminal cover) Conversion cable for the Z/ISE30A lead wire with connector With spacer for fitting extension			Grease-free M12 4-pin pre-wired connector (Lead wire length: 100 mm) Lead wire with connector (Terminal cover) Conversion cable for the Z/ISE30A lead wire with connector With spacer for fitting extension Pressure switch (for low pressure)		

## CONTENTS









### 3-Screen Display High-Precision Digital Pressure Switch ZSE20(F)/ISE20 Series

How to Order	p. 9
Specifications	p. 10
Set Pressure Range and Rated Pressure Range	p. 17
Functions	p. 17
Internal Circuits and Wiring Examples	p. 18
Dimensions	pp. 20 to 23

### 3-Screen Display High-Precision Digital Pressure Switch ZSE20A(F)/ISE20A Series

How to Order	p. 11
Specifications	p. 12
Set Pressure Range and Rated Pressure Range	p. 17
Analog Output	p. 17
Functions	p. 17
Internal Circuits and Wiring Examples	pp. 18, 19
Dimensions	pp. 20 to 23

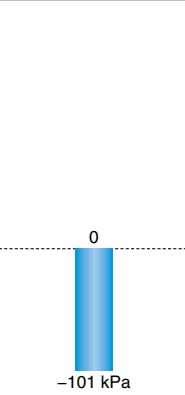
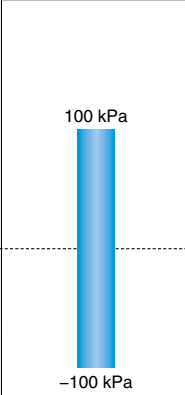
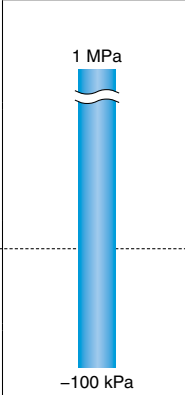
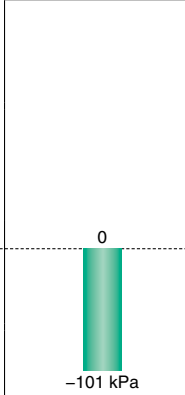
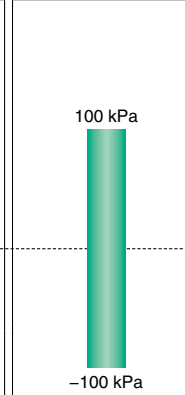
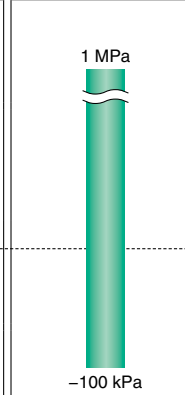
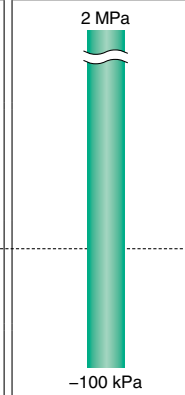

2 Outputs IP65 ZSE20B(F)/ISE20B p. 13			2 Outputs IP65 ZSE20C(F)/ISE20C(H) p. 25			
IO-Link 1 Output IP65 ZSE20B(F)-L/ISE20B-L p. 15			IO-Link 1 Output IP65 ZSE20C(F)-L/ISE20C(H)-L p. 27			
 Air			 General fluids			
For vacuum pressure	For compound pressure	For positive pressure	For vacuum pressure	For compound pressure	For positive pressure (1 MPa)	For positive pressure (2 MPa)
						
ZSE20B(-L)	ZSE20BF(-L)	ISE20B(-L)	ZSE20C(-L)	ZSE20CF(-L)	ISE20C(-L)	ISE20CH(-L)
						
500 kPa	500 kPa	1.5 MPa	500 kPa	500 kPa	2 MPa	4 MPa
2 outputs (NPN/PNP)/IO-Link*4			2 outputs (NPN/PNP)/IO-Link*4			
Analog (Voltage/Current)*5			Analog (Voltage/Current)			
IP65			IP65			
M5 female thread, R1/8, NPT1/8 ø4 mm One-touch fitting*5 ø6 mm One-touch fitting*5			R1/4*1, NPT1/4*1, G1/4*1, Rc1/8, URJ1/4*2, TSJ1/4*3			
Copy function*5, Auto-shift function*5			Copy function*5, Auto-shift function*5			
Grease-free*6 3 m lead wire*6 M8 3-pin pre-wired connector (Lead wire length: 500 mm)*6 M12 4-pin pre-wired connector (Lead wire length: 100 mm)*6 With spacer for fitting extension*6 □36 mm panel hole (Compatible with the panel holes of the Z/ISE40A and Z/ISE80)*6			Parts in contact with fluid: Stainless steel 316L*6 Restrictor-installed fitting*6 3 m lead wire*6 M12 4-pin pre-wired connector (Lead wire length: 100 mm)*6 □36 mm panel hole (Compatible with the panel holes of the Z/ISE40A and Z/ISE80)*6			

\*1 M5 female threaded \*2 Face seal fitting \*3 Compression fitting \*4 1 output in SIO mode (NPN or PNP switching type)  
\*5 This function is not provided with the IO-Link compatible type. \*6 Excludes the IO-Link compatible type (-L)

**3-Screen Display High-Precision Digital Pressure Switch ZSE20B(F)/ISE20B Series**

How to Order ..... p. 13  
 How to Order [M12 Connector Type] ..... p. 13-1  
 Specifications ..... p. 14

**3-Screen Display High-Precision Digital Pressure Switch/IO-Link Compatible ZSE20B(F)-L/ISE20B-L Series**

How to Order ..... p. 15  
 How to Order [M12 Connector Type] ..... p. 15-1  
 Specifications ..... p. 16  
 Set Pressure Range and Rated Pressure Range ..... p. 17  
 Analog Output ..... p. 17  
 IO-Link: Process Data ..... p. 17  
 Functions ..... p. 17  
 Internal Circuits and Wiring Examples ..... pp. 18, 19  
 Dimensions ..... pp. 20 to 23

**3-Screen Display High-Precision Digital Pressure Switch for General Fluids ZSE20C(F)/ISE20C(H) Series**

How to Order ..... p. 25  
 Specifications ..... p. 26

**3-Screen Display High-Precision Digital Pressure Switch for General Fluids/IO-Link Compatible ZSE20C(F)-L/ISE20C(H)-L Series**

How to Order ..... p. 27  
 Specifications ..... p. 28  
 Set Pressure Range and Rated Pressure Range ..... p. 29  
 Analog Output ..... p. 29  
 IO-Link: Process Data ..... p. 29  
 Functions ..... p. 29  
 Internal Circuits and Wiring Examples ..... pp. 30, 31  
 Dimensions ..... pp. 32 to 37  
**Function Details** ..... pp. 38 to 41  
**Made to Order** ..... pp. 42 to 48  
**Safety Instructions** ..... Back cover

1 Output

# 3-Screen Display High-Precision Digital Pressure Switch

# ZSE20(F)/ISE20 Series



RoHS

IP40



## How to Order

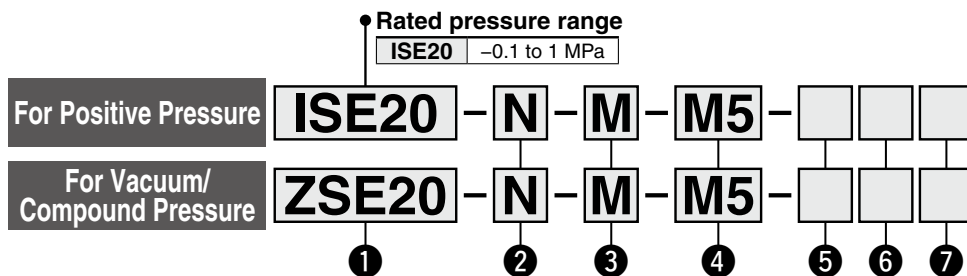

Made to Order (pp. 42 to 48)

### 1 Rated pressure range

ZSE20	0 to -101 kPa
ZSE20F	-100 to 100 kPa

### 2 Output specification

Symbol	Description
N	NPN open collector 1 output
P	PNP open collector 1 output

### 3 Unit specification

Symbol	Description
Nil	Units selection function*1
M	SI units only*2
P	Units selection function (Initial value psi)*1

\*1 Under the New Measurement Act, switches with the units selection function are no longer allowed for use in Japan.

\*2 Fixed units: kPa, MPa

### 4 Piping specification

Symbol	Description	Symbol	Description
M5	M5 female thread Piping port	C4H	One-touch fitting ø4 mm Straight type
		C6H	One-touch fitting ø6 mm
		N7H	One-touch fitting ø1/4 inch
01	R1/8 R1/8 Piping adapter ZS-46-N1	C4L	One-touch fitting ø4 mm Elbow type
		C6L	One-touch fitting ø6 mm
		N7L	One-touch fitting ø1/4 inch
N01	NPT1/8 NPT1/8 Piping adapter ZS-46-N2	* One-touch fitting is shipped together with the product.	

### 5 Option 1

Symbol	Description
Nil	Without lead wire
L	Lead wire with connector (3-core, 2 m lead wire)

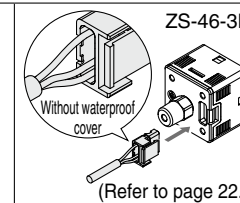

(Refer to page 22.)

\* For the lead wire with M12 connector, refer to page 43.

### 7 Option 3

Symbol	Operation manual*1	Calibration certificate*1
Nil	○	—
Y	—	—
K	—	—
T	—	○

\*1 All texts are in both English and Japanese.

### 6 Option 2

Symbol	Description
Nil	None
A1	Bracket A (Vertical mounting) ZS-46-A1
A2	Bracket B (Horizontal mounting) ZS-46-A2
B	Panel mount adapter ZS-46-B
D	Panel mount adapter + Front protection cover ZS-46-D

## Options/Part Nos.

When only optional parts are required, order with the part numbers listed below.

Description	Part no.	Note
Bracket A	ZS-46-A1	Tapping screw: Nominal size 3 x 8 L (2 pcs.)
Bracket B	ZS-46-A2	Tapping screw: Nominal size 3 x 8 L (2 pcs.)
Panel mount adapter	ZS-46-B	—
Panel mount adapter + Front protection cover	ZS-46-D	—
Lead wire with connector	ZS-46-3L	3-core, 2 m, Non-waterproof (Without waterproof cover)
Lead wire with M12 connector	ZS-46-5LM12	Made to order (Refer to page 43.)
Front protection cover	ZS-27-01	—
R1/8 Piping adapter	ZS-46-N1	R1/8 NPT1/8
NPT1/8 Piping adapter	ZS-46-N2	
One-touch fitting ø4 mm straight	ZS-46-C4H	—
One-touch fitting ø6 mm straight	ZS-46-C6H	—
One-touch fitting ø1/4 inch straight	ZS-46-N7H	—
One-touch fitting ø4 mm elbow	ZS-46-C4L	—
One-touch fitting ø6 mm elbow	ZS-46-C6L	—
One-touch fitting ø1/4 inch elbow	ZS-46-N7L	—
Spacer for fitting extension	ZS-46-M5A	Made to order (Refer to page 44.)

# 3-Screen Display High-Precision Digital Pressure Switch **ZSE20(F)/ISE20 Series**

For pressure switch precautions and specific product precautions, refer to the "Operation Manual" on the SMC website.



## Specifications

Model		ZSE20 (Vacuum pressure)	ZSE20F (Compound pressure)	ISE20 (Positive pressure)	
<b>Applicable fluid</b>		Air, Non-corrosive gas, Non-flammable gas			
<b>Pressure</b>	<b>Rated pressure range</b>	0.0 to -101.0 kPa	-100.0 to 100.0 kPa	-0.100 to 1.000 MPa	
	<b>Display/Set pressure range</b>	10.0 to -105.0 kPa	-105.0 to 105.0 kPa	-0.105 to 1.050 MPa	
	<b>Display/Smallest settable increment</b>	0.1 kPa		0.001 MPa	
	<b>Withstand pressure</b>	500 kPa		1.5 MPa	
<b>Power supply</b>	<b>Power supply voltage</b>	12 to 24 VDC ±10%, Ripple (p-p) 10% or less			
	<b>Current consumption</b>	25 mA or less			
	<b>Protection</b>	Polarity protection			
<b>Accuracy</b>	<b>Display accuracy</b>	±2% F.S. ±1 digit (Ambient temperature of 25 ±3°C)			
	<b>Repeatability</b>	±0.2% F.S. ±1 digit			
	<b>Temperature characteristics</b>	±2% F.S. (25°C standard)			
<b>Switch output</b>	<b>Output type</b>	NPN or PNP open collector 1 output			
	<b>Output mode</b>	Hysteresis mode, Window comparator mode, Error output, Output OFF			
	<b>Switch operation</b>	Normal output, Reversed output			
	<b>Max. load current</b>	80 mA			
	<b>Max. applied voltage (NPN only)</b>	28 V			
	<b>Internal voltage drop (Residual voltage)</b>	1 V or less (at load current of 80 mA)			
	<b>Delay time*1</b>	1.5 ms or less (with anti-chattering function: 20, 100, 500, 1000, 2000, 5000 ms)			
	<b>Hysteresis</b>	<b>Hysteresis mode</b>	Variable from 0*2		
		<b>Window comparator mode</b>			
	<b>Short circuit protection</b>	Yes			
<b>Display</b>	<b>Unit*3</b>	MPa, kPa, kgf/cm <sup>2</sup> , bar, psi, inHg, mmHg		MPa, kPa, kgf/cm <sup>2</sup> , bar, psi	
	<b>Display type</b>	LCD			
	<b>Number of screens</b>	3-screen display (Main screen, Sub screen x 2)			
	<b>Display color</b>	1) Main screen: Red/Green 2) Sub screen: Orange			
	<b>Number of display digits</b>	1) Main screen: 4 digits (7 segments) 2) Sub screen: 4 digits (Upper 1 digit 11 segments, 7 segments for other)			
	<b>Indicator light</b>	Lights up when switch output is turned ON. OUT1: Orange			
<b>Digital filter*4</b>	0, 10, 50, 100, 500, 1000, 5000 ms				
<b>Environmental resistance</b>	<b>Enclosure</b>	IP40			
	<b>Withstand voltage</b>	1000 VAC for 1 minute between terminals and housing			
	<b>Insulation resistance</b>	50 MΩ or more (500 VDC measured via megohmmeter) between terminals and housing			
	<b>Operating temperature range</b>	Operating: -5 to 50°C, Stored: -10 to 60°C (No condensation or freezing)			
	<b>Operating humidity range</b>	Operating/Stored: 35 to 85% RH (No condensation)			
<b>Standards</b>	UL/CSA (E216656), CE/UKCA marking				
<b>Length of lead wire with connector</b>	2 m				

\*1 Value without digital filter (at 0 ms)

\*2 If the applied pressure fluctuates around the set value, the hysteresis must be set to a value greater than the amount of fluctuation, or chattering will occur.

\*3 Setting is only possible for models with the units selection function. Only MPa or kPa is available for models without this function.

\*4 The response time indicates when the set value is 90% in relation to the step input.

\* Products with tiny scratches, marks, or display color or brightness variations which do not affect the performance of the product are verified as conforming products.

## Piping Specifications and Weights

Model	M5	O1	N01	C4H	C6H	N7H	C4L	C6L	N7L	
<b>Port size</b>	M5 x 0.8	R1/8	NPT1/8	—	—	—	—	—	—	
	<b>One-touch fitting Straight type</b>	—	—	—	ø4 mm ø5/32 inch	ø6 mm	ø1/4 inch	—	—	
	<b>One-touch fitting Elbow type</b>	—	—	—	—	—	ø4 mm ø5/32 inch	ø6 mm	ø1/4 inch	
<b>Materials of parts in contact with fluid</b>	<b>Sensor pressure receiving area</b>	Silicon								
	<b>Piping port (Common)</b>	PBT, CB156, Heat-resistant PPS, O-ring: HNBR								
	<b>Piping port</b>	—	C3604 (Electroless nickel plating), Stainless steel 304, NBR			POM, Stainless steel 304, NBR, C3604				
<b>Weight</b>	<b>Body</b>	22 g	32 g	34 g	25 g	26 g	27 g	28 g	28 g	34 g
	<b>Lead wire with connector</b>	+35 g								

## Cable Specifications

<b>Conductor cross section</b>	0.15 mm <sup>2</sup> (AWG26)	
<b>Insulator</b>	<b>O.D.</b>	1.0 mm
	<b>Color</b>	Brown, Blue, Black (3-core)
<b>Sheath</b>	<b>Finished O.D.</b>	ø3.4

"Set Pressure Range and Rated Pressure Range," "Functions" → p. 17  
 "Internal Circuits and Wiring Examples" → p. 18 "Dimensions" → From p. 20

2 Outputs + Analog Output (Voltage/Current)



3-Screen Display High-Precision Digital Pressure Switch

RoHS

IP40

# ZSE20A(F)/ISE20A Series



## How to Order

For Positive Pressure

ISE20A - X - M - M5 - [ ] - [ ] - [ ]

For Vacuum/Compound Pressure

ZSE20A - X - M - M5 - [ ] - [ ] - [ ]



Made to Order (pp. 42 to 48)

Rated pressure range

ISE20A -0.1 to 1 MPa

1

2

3

4

5

6

7

### 1 Rated pressure range

ZSE20A	0 to -101 kPa
ZSE20AF	-100 to 100 kPa

### 2 Output specification

Symbol	Description
R	NPN open collector 2 outputs + Analog voltage output *1
S	NPN open collector 2 outputs + Analog current output *1
T	PNP open collector 2 outputs + Analog voltage output *1
V	PNP open collector 2 outputs + Analog current output *1
X	NPN open collector 2 outputs + Copy function
Y	PNP open collector 2 outputs + Copy function

\*1 Can be switched to auto-shift or copy function

### 3 Unit specification

Symbol	Description
Nil	Units selection function*1
M	SI units only*2
P	Units selection function (Initial value psi)*1

\*1 Under the New Measurement Act, switches with the units selection function are no longer allowed for use in Japan.

\*2 Fixed units: kPa, MPa

### 4 Piping specification

Symbol	Description	Symbol	Description	
M5	M5 female thread Piping port	C4H	One-touch fitting ø4 mm	Straight type
		C6H	One-touch fitting ø6 mm	
		N7H	One-touch fitting ø1/4 inch	
01	R1/8 R1/8 Piping adapter ZS-46-N1	C4L	One-touch fitting ø4 mm	Elbow type
		C6L	One-touch fitting ø6 mm	
		N7L	One-touch fitting ø1/4 inch	
N01	NPT1/8 NPT1/8 Piping adapter ZS-46-N2	* One-touch fitting is shipped together with the product.		

### 5 Option 1

Symbol	Description
Nil	Without lead wire
J	Lead wire with connector (5-core, 2 m lead wire)

\* For the lead wire with M12 connector, refer to page 43.

### 7 Option 3

Symbol	Operation manual*1	Calibration certificate*1
Nil	○	—
Y	—	—
K	○	○
T	—	○

\*1 All texts are in both English and Japanese.

### 6 Option 2

Symbol	Description
Nil	None
A1	Bracket A (Vertical mounting) ZS-46-A1
A2	Bracket B (Horizontal mounting) ZS-46-A2
B	Panel mount adapter ZS-46-B
D	Panel mount adapter + Front protection cover ZS-46-D

## Options/Part Nos.

When only optional parts are required, order with the part numbers listed below.

Description	Part no.	Note
Bracket A	ZS-46-A1	Tapping screw: Nominal size 3 x 8 L (2 pcs.)
Bracket B	ZS-46-A2	Tapping screw: Nominal size 3 x 8 L (2 pcs.)
Panel mount adapter	ZS-46-B	—
Panel mount adapter + Front protection cover	ZS-46-D	—
Lead wire with connector	ZS-46-5L	5-core, 2 m, Non-waterproof (Without waterproof cover)
Lead wire with M12 connector	ZS-46-5LM12	Made to order (Refer to page 43.)
Front protection cover	ZS-27-01	—
R1/8 Piping adapter	ZS-46-N1	R1/8
NPT1/8 Piping adapter	ZS-46-N2	NPT1/8
One-touch fitting ø4 mm straight	ZS-46-C4H	—
One-touch fitting ø6 mm straight	ZS-46-C6H	—
One-touch fitting ø1/4 inch straight	ZS-46-N7H	—
One-touch fitting ø4 mm elbow	ZS-46-C4L	—
One-touch fitting ø6 mm elbow	ZS-46-C6L	—
One-touch fitting ø1/4 inch elbow	ZS-46-N7L	—
Spacer for fitting extension	ZS-46-M5A	Made to order (Refer to page 44.)

# 3-Screen Display High-Precision Digital Pressure Switch **ZSE20A(F)/ISE20A Series**

For pressure switch precautions and specific product precautions, refer to the "Operation Manual" on the SMC website.



## Specifications

Model		ZSE20A (Vacuum pressure)	ZSE20AF (Compound pressure)	ISE20A (Positive pressure)	
<b>Applicable fluid</b>		Air, Non-corrosive gas, Non-flammable gas			
<b>Pressure</b>	<b>Rated pressure range</b>	0.0 to -101.0 kPa	-100.0 to 100.0 kPa	-0.100 to 1.000 MPa	
	<b>Display/Set pressure range</b>	10.0 to -105.0 kPa	-105.0 to 105.0 kPa	-0.105 to 1.050 MPa	
	<b>Display/Smallest settable increment</b>	0.1 kPa		0.001 MPa	
	<b>Withstand pressure</b>	500 kPa		1.5 MPa	
<b>Power supply</b>	<b>Power supply voltage</b>	12 to 24 VDC ±10%, Ripple (p-p) 10% or less			
	<b>Current consumption</b>	35 mA or less			
	<b>Protection</b>	Polarity protection			
<b>Accuracy</b>	<b>Display accuracy</b>	±2% F.S. ±1 digit (Ambient temperature of 25 ±3°C)			
	<b>Repeatability</b>	±0.2% F.S. ±1 digit			
	<b>Analog output accuracy</b>	±2.5% F.S. (Ambient temperature of 25 ±3°C)			
	<b>Analog output linearity</b>	±1% F.S.			
	<b>Temperature characteristics</b>	±2% F.S. (25°C standard)			
<b>Switch output</b>	<b>Output type</b>	NPN or PNP open collector 2 outputs			
	<b>Output mode</b>	Hysteresis mode, Window comparator mode, Error output, Output OFF			
	<b>Switch operation</b>	Normal output, Reversed output			
	<b>Max. load current</b>	80 mA			
	<b>Max. applied voltage (NPN only)</b>	28 V			
	<b>Internal voltage drop (Residual voltage)</b>	1 V or less (at load current of 80 mA)			
	<b>Delay time</b> *1	1.5 ms or less (with anti-chattering function: 20, 100, 500, 1000, 2000, 5000 ms)			
	<b>Hysteresis</b>	<b>Hysteresis mode</b>	Variable from 0*2		
		<b>Window comparator mode</b>			
	<b>Short circuit protection</b>	Yes			
<b>Analog output</b>	<b>Voltage output</b>	<b>Output type</b>	Voltage output: 1 to 5 V	Voltage output: 0.6 to 5 V	
		<b>Output impedance</b>	Approx. 1 kΩ		
	<b>Current output</b>	<b>Output type</b>	Current output: 4 to 20 mA	Current output: 2.4 to 20 mA	
		<b>Load impedance</b>	Maximum load impedance at power supply voltage of 12 V: 300 Ω at power supply voltage of 24 V: 600 Ω Minimum load impedance: 50 Ω		
<b>Auto-shift input</b>	<b>Input type</b>	Non-voltage input: 0.4 V or less			
	<b>Input mode</b>	Select from Auto-shift or Auto-shift zero.			
	<b>Input time</b>	5 ms or more			
<b>Display</b>	<b>Unit</b> *3	MPa, kPa, kgf/cm <sup>2</sup> , bar, psi, inHg, mmHg	MPa, kPa, kgf/cm <sup>2</sup> , bar, psi		
	<b>Display type</b>	LCD			
	<b>Number of screens</b>	3-screen display (Main screen, Sub screen x 2)			
	<b>Display color</b>	1) Main screen: Red/Green 2) Sub screen: Orange			
	<b>Number of display digits</b>	1) Main screen: 4 digits (7 segments) 2) Sub screen: 4 digits (Upper 1 digit 11 segments, 7 segments for other)			
	<b>Indicator light</b>	Lights up when switch output is turned ON. OUT1, OUT2: Orange			
<b>Digital filter</b> *4	0, 10, 50, 100, 500, 1000, 5000 ms				
<b>Environmental resistance</b>	<b>Enclosure</b>	IP40			
	<b>Withstand voltage</b>	1000 VAC for 1 minute between terminals and housing			
	<b>Insulation resistance</b>	50 MΩ or more (500 VDC measured via megohmmeter) between terminals and housing			
	<b>Operating temperature range</b>	Operating: -5 to 50°C, Stored: -10 to 60°C (No condensation or freezing)			
	<b>Operating humidity range</b>	Operating/Stored: 35 to 85% RH (No condensation)			
<b>Standards</b>	UL/CSA (E216656), CE/UKCA marking				
<b>Length of lead wire with connector</b>	2 m				

\*1 Value without digital filter (at 0 ms)

\*2 If the applied pressure fluctuates around the set value, the hysteresis must be set to a value greater than the amount of fluctuation, or chattering will occur.

\*3 Setting is only possible for models with the units selection function. Only MPa or kPa is available for models without this function.

\*4 The response time indicates when the set value is 90% in relation to the step input.

\* Products with tiny scratches, marks, or display color or brightness variations which do not affect the performance of the product are verified as conforming products.

## Piping Specifications and Weights

Model	M5	01	N01	C4H	C6H	N7H	C4L	C6L	N7L
<b>Port size</b>	M5 x 0.8	R1/8	NPT1/8	—	—	—	—	—	—
<b>One-touch fitting</b>	<b>Straight type</b>	—	—	∅4 mm ∅5/32 inch	∅6 mm	∅1/4 inch	—	—	—
	<b>Elbow type</b>	—	—	—	—	—	∅4 mm ∅5/32 inch	∅6 mm	∅1/4 inch
<b>Materials of parts in contact with fluid</b>	<b>Sensor pressure receiving area</b>	Silicon							
	<b>Piping port (Common)</b>	PBT, CB156, Heat-resistant PPS, O-ring: HNBR							
	<b>Piping port</b>	—	C3604 (Electroless nickel plating), Stainless steel 304, NBR	POM, Stainless steel 304, NBR, C3604					
<b>Weight</b>	<b>Body</b>	24 g	34 g	36 g	27 g	28 g	29 g	30 g	36 g
	<b>Lead wire with connector</b>	+39 g							

## Cable Specifications

<b>Conductor cross section</b>	0.15 mm <sup>2</sup> (AWG26)	
<b>Insulator</b>	<b>O.D.</b>	1.0 mm
	<b>Color</b>	Brown, Blue, Black, White, Gray (5-core)
<b>Sheath</b>	<b>Finished O.D.</b>	∅3.5

"Set Pressure Range and Rated Pressure Range," "Functions" → p. 17

"Internal Circuits and Wiring Examples" → From p. 18 "Dimensions" → From p. 20

2 Outputs + Analog Output (Voltage/Current)



3-Screen Display High-Precision Digital Pressure Switch

RoHS

IP65

# ZSE20B(F)/ISE20B Series

For the IO-Link compatible type, refer to page 15.  
For the M12 connector type, refer to page 13-1.

## How to Order

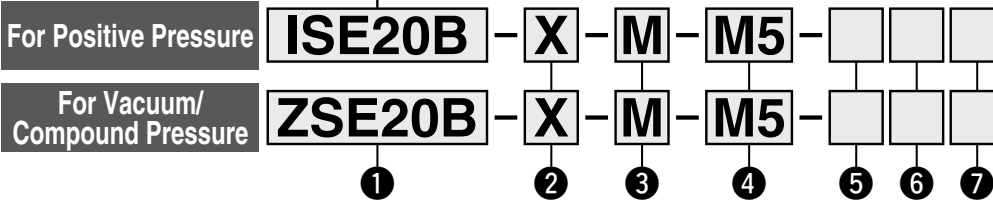

Made to Order (pp. 42 to 48)

### 1 Rated pressure range

<b>ZSE20B</b>	0 to -101 kPa
<b>ZSE20BF</b>	-100 to 100 kPa

### 2 Output specification

Symbol	Description
<b>R</b>	NPN open collector 2 outputs + Analog voltage output *1
<b>S</b>	NPN open collector 2 outputs + Analog current output *1
<b>T</b>	PNP open collector 2 outputs + Analog voltage output *1
<b>V</b>	PNP open collector 2 outputs + Analog current output *1
<b>X</b>	NPN open collector 2 outputs + Copy function
<b>Y</b>	PNP open collector 2 outputs + Copy function

\*1 Can be switched to auto-shift or copy function

### 3 Unit specification

Symbol	Description
<b>Nil</b>	Units selection function*1
<b>M</b>	SI units only*2
<b>P</b>	Units selection function (Initial value psi)*1

\*1 Under the New Measurement Act, switches with the units selection function are no longer allowed for use in Japan.

\*2 Fixed units: kPa, MPa

### 4 Piping specification

Symbol	Description	Symbol	Description
<b>M5</b>	M5 female thread Piping port	<b>C4L</b>	One-touch fitting ø4 mm Elbow type
		<b>C6L</b>	One-touch fitting ø6 mm
<b>01</b>	R1/8 R1/8 Piping adapter ZS-46-N1	* One-touch fitting is shipped together with the product.	
<b>N01</b>	NPT1/8 NPT1/8 Piping adapter ZS-46-N2		

### 5 Option 1

Symbol	Description
<b>Nil</b>	Without lead wire
<b>W</b>	Lead wire with connector (5-core, 2 m lead wire, With waterproof cover)

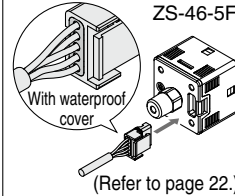

\* For the lead wire with M12 connector, refer to page 43.

### 7 Option 3

Symbol	Operation manual*1	Calibration certificate*1
<b>Nil</b>	○	—
<b>Y</b>	—	—
<b>K</b>	○	○
<b>T</b>	—	○

\*1 All texts are in both English and Japanese.

### 6 Option 2

Symbol	Description
<b>Nil</b>	None
<b>A1</b>	Bracket A (Vertical mounting) ZS-46-A1
<b>A2</b>	Bracket B (Horizontal mounting) ZS-46-A2
<b>B</b>	Panel mount adapter ZS-46-B
<b>D</b>	Panel mount adapter + Front protection cover ZS-46-D

## Options/Part Nos.

When only optional parts are required, order with the part numbers listed below.

Description	Part no.	Note
Bracket A	<b>ZS-46-A1</b>	Tapping screw: Nominal size 3 x 8 L (2 pcs.)
Bracket B	<b>ZS-46-A2</b>	Tapping screw: Nominal size 3 x 8 L (2 pcs.)
Panel mount adapter	<b>ZS-46-B</b>	—
Panel mount adapter + Front protection cover	<b>ZS-46-D</b>	—
Panel mount adapter (Compatible with the panel holes of the Z/ISE40A)	<b>ZS-46-F</b>	Made to order (Refer to page 45.)
Panel mount adapter + Front protection cover (Compatible with the panel holes of the Z/ISE40A)	<b>ZS-46-G</b>	Made to order (Refer to page 45.)
Lead wire with connector	<b>ZS-46-5F</b>	5-core, 2 m, Waterproof (With waterproof cover)
Lead wire with M12 connector	<b>ZS-46-5FM12</b>	Made to order (Refer to page 43.)
Front protection cover	<b>ZS-27-01</b>	—
R1/8 Piping adapter	<b>ZS-46-N1</b>	R1/8 NPT1/8
NPT1/8 Piping adapter	<b>ZS-46-N2</b>	
One-touch fitting ø4 mm elbow	<b>ZS-46-C4L</b>	—
One-touch fitting ø6 mm elbow	<b>ZS-46-C6L</b>	—
Spacer for fitting extension	<b>ZS-46-M5A</b>	Made to order (Refer to page 44.)

# 3-Screen Display High-Precision Digital Pressure Switch **ZSE20B(F)/ISE20B Series**



## How to Order [M12 Connector Type]

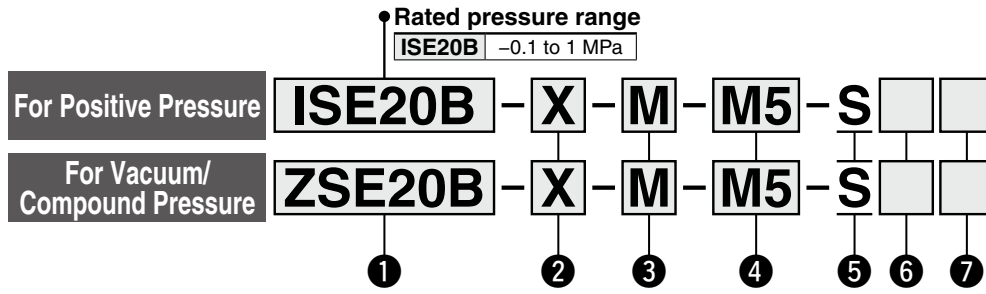

Made to Order (pp. 42 to 48)

### ① Rated pressure range

<b>ZSE20B</b>	0 to -101 kPa
<b>ZSE20BF</b>	-100 to 100 kPa

### ② Output specification

Symbol	Description
<b>R</b>	NPN open collector 1 output + Analog voltage output*1
<b>S</b>	NPN open collector 1 output + Analog current output*1
<b>T</b>	PNP open collector 1 output + Analog voltage output*1
<b>V</b>	PNP open collector 1 output + Analog current output*1
<b>X</b>	NPN open collector 2 outputs
<b>Y</b>	PNP open collector 2 outputs

\*1 Can be switched to auto-shift or copy

### ③ Unit specification

Symbol	Description
<b>Nil</b>	Units selection function*1
<b>M</b>	SI units only*2
<b>P</b>	Units selection function (Initial value psi)*1

\*1 Under the New Measurement Act, switches with the units selection function are no longer allowed for use in Japan.

\*2 Fixed units: kPa, MPa

### ④ Piping specification

Symbol	Description
<b>M5</b>	M5 female thread
<b>O1</b>	R1/8
<b>N01</b>	NPT1/8
<b>C4L</b>	One-touch fitting ø4 mm (Elbow type)
<b>C6L</b>	One-touch fitting ø6 mm (Elbow type)

### ⑤ Option 1

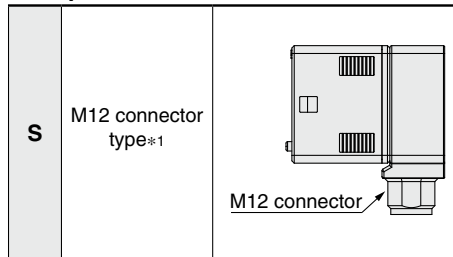

\*1 Lead wire is not included.

### ⑥ Option 2

Nil	None
<b>A4</b>	Bracket D (For M12 connector type)  ZS-46-A4
<b>A5</b>	Bracket E (For M12 connector type)  ZS-46-A5

### ⑦ Option 3

Symbol	Operation manual*1	Calibration certificate*1
<b>Nil</b>	○	—
<b>Y</b>	—	—
<b>K</b>	○	○
<b>T</b>	—	○

\*1 All texts are in both English and Japanese.

## Options/Part Nos.

When only optional parts are required, order with the part numbers listed below.

Description	Part no.	Note
Bracket D	<b>ZS-46-A4</b>	Tapping screw: Nominal size 3 x 8 L (2 pcs.)
Bracket E	<b>ZS-46-A5</b>	Tapping screw: Nominal size 3 x 8 L (2 pcs.)
Lead wire with M12 connector (Straight)	<b>ZS-37-A</b>	3 m lead wire
	<b>ZS-31-B</b>	5 m lead wire
Lead wire with M12 connector (Right-angle)	<b>ZS-37-B</b>	3 m lead wire
	<b>ZS-31-C</b>	5 m lead wire
Lead wire with M12 connector (Connectors on both sides)	<b>EX9-AC005-SSPS</b>	0.5 m lead wire, straight
	<b>EX9-AC010-SSPS</b>	1 m lead wire, straight
	<b>EX9-AC020-SSPS</b>	2 m lead wire, straight
	<b>EX9-AC030-SSPS</b>	3 m lead wire, straight
	<b>EX9-AC050-SSPS</b>	5 m lead wire, straight
	<b>EX9-AC100-SSPS</b>	10 m lead wire, straight
R1/8 Piping adapter	<b>ZS-46-N1</b>	R1/8
NPT1/8 Piping adapter	<b>ZS-46-N2</b>	NPT1/8
One-touch fitting ø4 mm elbow	<b>ZS-46-C4L</b>	—
One-touch fitting ø6 mm elbow	<b>ZS-46-C6L</b>	—





# 3-Screen Display High-Precision Digital Pressure Switch **ZSE20B(F)/ISE20B Series**

For pressure switch precautions and specific product precautions, refer to the "Operation Manual" on the SMC website.



## Specifications

Model		ZSE20B (Vacuum pressure)	ZSE20BF (Compound pressure)	ISE20B (Positive pressure)	
<b>Applicable fluid</b>		Air, Non-corrosive gas, Non-flammable gas			
<b>Pressure</b>	<b>Rated pressure range</b>	0.0 to -101.0 kPa	-100.0 to 100.0 kPa	-0.100 to 1.000 MPa	
	<b>Display/Set pressure range</b>	10.0 to -105.0 kPa	-105.0 to 105.0 kPa	-0.105 to 1.050 MPa	
	<b>Display/Smallest settable increment</b>	0.1 kPa		0.001 MPa	
	<b>Withstand pressure</b>	500 kPa		1.5 MPa	
<b>Power supply</b>	<b>Power supply voltage</b>	12 to 24 VDC ±10%, Ripple (p-p) 10% or less			
	<b>Current consumption</b>	35 mA or less			
	<b>Protection</b>	Polarity protection			
<b>Accuracy</b>	<b>Display accuracy</b>	±2% F.S. ±1 digit (Ambient temperature of 25 ±3°C)			
	<b>Repeatability</b>	±0.2% F.S. ±1 digit			
	<b>Analog output accuracy</b>	±2.5% F.S. (Ambient temperature of 25 ±3°C)			
	<b>Analog output linearity</b>	±1% F.S.			
	<b>Temperature characteristics</b>	±2% F.S. (25°C standard)			
<b>Switch output</b>	<b>Output type</b>	NPN or PNP open collector 1 output or 2 outputs			
	<b>Output mode</b>	Hysteresis mode, Window comparator mode, Error output, Output OFF			
	<b>Switch operation</b>	Normal output, Reversed output			
	<b>Max. load current</b>	80 mA			
	<b>Max. applied voltage (NPN only)</b>	28 V			
	<b>Internal voltage drop (Residual voltage)</b>	1 V or less (at load current of 80 mA)			
	<b>Delay time*1</b>	1.5 ms or less (with anti-chattering function: 20, 100, 500, 1000, 2000, 5000 ms)			
	<b>Hysteresis</b>	<b>Hysteresis mode</b>	Variable from 0*2		
		<b>Window comparator mode</b>			
	<b>Short circuit protection</b>	Yes			
<b>Analog output</b>	<b>Voltage output</b>	<b>Output type</b>	Voltage output: 1 to 5 V	Voltage output: 0.6 to 5 V	
		<b>Output impedance</b>	Approx. 1 kΩ		
	<b>Current output</b>	<b>Output type</b>	Current output: 4 to 20 mA	Current output: 2.4 to 20 mA	
		<b>Load impedance</b>	Maximum load impedance at power supply voltage of 12 V: 300 Ω at power supply voltage of 24 V: 600 Ω Minimum load impedance: 50 Ω		
<b>Auto-shift input</b>	<b>Input type</b>	Non-voltage input: 0.4 V or less			
	<b>Input mode</b>	Select from Auto-shift or Auto-shift zero.			
	<b>Input time</b>	5 ms or more			
<b>Display</b>	<b>Unit*3</b>	MPa, kPa, kgf/cm <sup>2</sup> , bar, psi, inHg, mmHg	MPa, kPa, kgf/cm <sup>2</sup> , bar, psi		
	<b>Display type</b>	LCD			
	<b>Number of screens</b>	3-screen display (Main screen, Sub screen x 2)			
	<b>Display color</b>	1) Main screen: Red/Green 2) Sub screen: Orange			
	<b>Number of display digits</b>	1) Main screen: 4 digits (7 segments) 2) Sub screen: 4 digits (Upper 1 digit 11 segments, 7 segments for other)			
	<b>Indicator light</b>	Lights up when switch output is turned ON. OUT1, OUT2: Orange			
<b>Digital filter*4</b>	0, 10, 50, 100, 500, 1000, 5000 ms				
<b>Environmental resistance</b>	<b>Enclosure</b>	IP65			
	<b>Withstand voltage</b>	1000 VAC for 1 minute between terminals and housing			
	<b>Insulation resistance</b>	50 MΩ or more (500 VDC measured via megohmmeter) between terminals and housing			
	<b>Operating temperature range</b>	Operating: -5 to 50°C, Stored: -10 to 60°C (No condensation or freezing)			
<b>Operating humidity range</b>	Operating/Stored: 35 to 85% RH (No condensation)				
<b>Standards</b>	UL/CSA (E216656), CE/UKCA marking				
<b>Length of lead wire with connector</b>		2 m			

\*1 Value without digital filter (at 0 ms)

\*2 If the applied pressure fluctuates around the set value, the hysteresis must be set to a value greater than the amount of fluctuation, or chattering will occur.

\*3 Setting is only possible for models with the units selection function. Only MPa or kPa is available for models without this function.

\*4 The response time indicates when the set value is 90% in relation to the step input.

\* Products with tiny scratches, marks, or display color or brightness variations which do not affect the performance of the product are verified as conforming products.

## Piping Specifications and Weights

Model	M5	01	N01	C4L	C6L
<b>Port size</b>	M5 x 0.8	R1/8	NPT1/8	—	—
<b>One-touch fitting</b>	<b>Straight type</b>	—	—	—	—
	<b>Elbow type</b>	—	—	—	—
<b>Materials of parts in contact with fluid</b>	<b>Sensor pressure receiving area</b>	Silicon			
	<b>Piping port (Common)</b>	PBT, CB156, Heat-resistant PPS, O-ring: HNBR			
	<b>Piping port</b>	—	C3604 (Electroless nickel plating), Stainless steel 304, NBR	POM, Stainless steel 304, NBR, C3604	
<b>Weight</b>	<b>Body</b>	24 g	34 g	36 g	30 g
	<b>Lead wire with connector</b>	+39 g			
	<b>M12 connector type</b>	43 g	53 g	55 g	49 g

## Cable Specifications

<b>Conductor cross section</b>	0.15 mm <sup>2</sup> (AWG26)	
<b>Insulator</b>	<b>O.D.</b>	1.0 mm
	<b>Color</b>	Brown, Blue, Black, White, Gray (5-core)
<b>Sheath</b>	<b>Finished O.D.</b>	ø3.5

"Set Pressure Range and Rated Pressure Range,"  
"Functions" → p. 17  
"Internal Circuits and Wiring Examples" → From  
p. 18 "Dimensions" → From p. 20

IO-Link Compatible (1 Output)



RoHS

IP65

# 3-Screen Display High-Precision Digital Pressure Switch

# ZSE20B(F)-L/ISE20B-L Series



For 2 outputs + analog output type, refer to page 13.  
For the M12 connector type, refer to page 15-1.

## How to Order

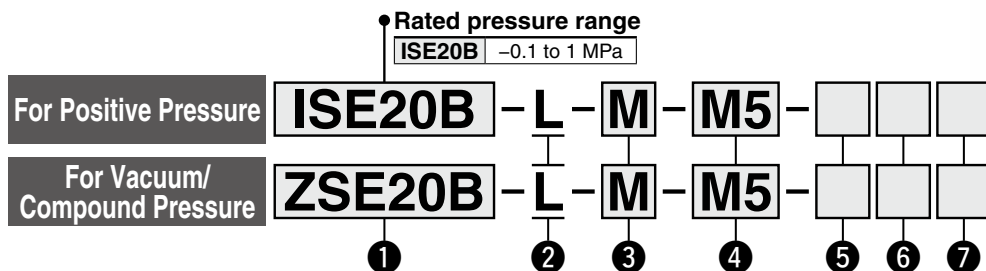

### 1 Rated pressure range

ZSE20B	0 to -101 kPa
ZSE20BF	-100 to 100 kPa

### 2 Output specification

Symbol	Description
L	IO-Link/Switch: 1 output ← (PNP or NPN switching type for switch output)

### 3 Unit specification

Symbol	Description
Nil	Units selection function*1
M	SI units only*2
P	Units selection function (Initial value psi)*1

\*1 Under the New Measurement Act, switches with the units selection function are no longer allowed for use in Japan.  
\*2 Fixed units: kPa, MPa

### 4 Piping specification

Symbol	Description
M5	M5 female thread 
01	R1/8 R1/8 Piping adapter ZS-46-N1 
N01	NPT1/8 NPT1/8 Piping adapter ZS-46-N2 

### 5 Option 1

Symbol	Description
Nil	Without lead wire
W	Lead wire with connector (5-core, 2 m lead wire, With waterproof cover) 

(Refer to page 22.)

\* For the lead wire with M12 connector, refer to page 43.

### 7 Option 3

Symbol	Operation manual*1	Calibration certificate*1
Nil	○	—
Y	—	—
K	○	○
T	—	○

\*1 All texts are in both English and Japanese.

### 6 Option 2

Symbol	Description
Nil	None
A1	Bracket A (Vertical mounting) 
A2	Bracket B (Horizontal mounting) 
B	Panel mount adapter 
D	Panel mount adapter + Front protection cover 

## Options/Part Nos.

When only optional parts are required, order with the part numbers listed below.

Description	Part no.	Note
Bracket A	ZS-46-A1	Tapping screw: Nominal size 3 x 8 L (2 pcs.)
Bracket B	ZS-46-A2	Tapping screw: Nominal size 3 x 8 L (2 pcs.)
Panel mount adapter	ZS-46-B	—
Panel mount adapter + Front protection cover	ZS-46-D	—
Lead wire with connector	ZS-46-5F	5-core, 2 m, Waterproof (With waterproof cover)
Lead wire with M12 connector	ZS-46-5FM12	 Made to order (Refer to page 43.)
Front protection cover	ZS-27-01	—
R1/8 Piping adapter	ZS-46-N1	R1/8  NPT1/8
NPT1/8 Piping adapter	ZS-46-N2	



### How to Order [M12 Connector Type]

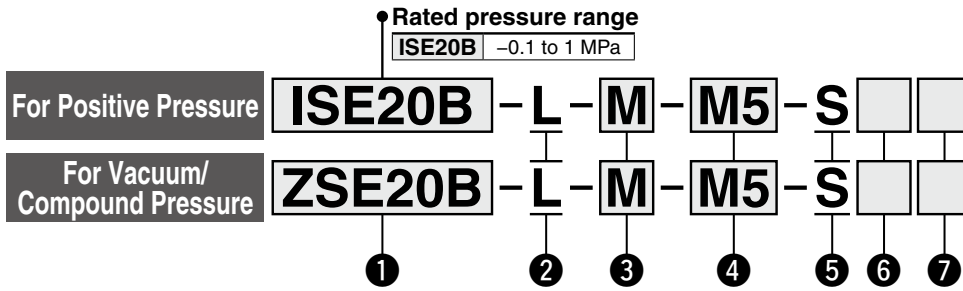

#### ① Rated pressure range

ZSE20B	0 to -101 kPa
ZSE20BF	-100 to 100 kPa

#### ② Output specification

Symbol	Description
L	IO-Link/Switch: 1 output ← (PNP or NPN switching type for switch output)

#### ③ Unit specification

Symbol	Description
Nil	Units selection function*1
M	SI units only*2
P	Units selection function (Initial value psi)*1

\*1 Under the New Measurement Act, switches with the units selection function are no longer allowed for use in Japan.

\*2 Fixed units: kPa, MPa

#### ④ Piping specification

Symbol	Description
M5	M5 female thread
O1	R1/8
N01	NPT1/8

#### ⑤ Option 1

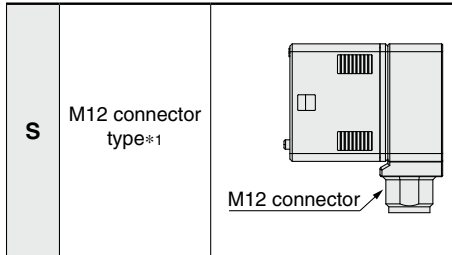

\*1 Lead wire is not included.

#### ⑥ Option 2

Nil	None	
A4	Bracket D (For M12 connector type)	 ZS-46-A4
		 ZS-46-A5
A5	Bracket E (For M12 connector type)	 ZS-46-A5

#### ⑦ Option 3

Symbol	Operation manual*1	Calibration certificate*1
Nil	○	—
Y	—	—
K	○	○
T	—	○

\*1 All texts are in both English and Japanese.

### Options/Part Nos.

When only optional parts are required, order with the part numbers listed below.

Description	Part no.	Note	
Bracket D	ZS-46-A4	Tapping screw: Nominal size 3 x 8 L (2 pcs.)	
Bracket E	ZS-46-A5	Tapping screw: Nominal size 3 x 8 L (2 pcs.)	
Lead wire with M12 connector (Straight)	ZS-37-A	3 m lead wire	
	ZS-31-B	5 m lead wire	
Lead wire with M12 connector (Right-angle)	ZS-37-B	3 m lead wire	
	ZS-31-C	5 m lead wire	
Lead wire with M12 connector (Connectors on both sides)	EX9-AC005-SSPS	0.5 m lead wire, straight	
	EX9-AC010-SSPS	1 m lead wire, straight	
	EX9-AC020-SSPS	2 m lead wire, straight	
	EX9-AC030-SSPS	3 m lead wire, straight	
	EX9-AC050-SSPS	5 m lead wire, straight	
EX9-AC100-SSPS	10 m lead wire, straight		
R1/8 Piping adapter	ZS-46-N1	R1/8	NPT1/8
NPT1/8 Piping adapter	ZS-46-N2		
One-touch fitting ø4 mm elbow	ZS-46-C4L	—	
One-touch fitting ø6 mm elbow	ZS-46-C6L	—	



# 3-Screen Display High-Precision Digital Pressure Switch **ZSE20B(F)-L/ISE20B-L Series**

For pressure switch precautions and specific product precautions, refer to the "Operation Manual" on the SMC website.



## Specifications/IO-Link Compatible

Model		ZSE20B-L (Vacuum pressure)	ZSE20BF-L (Compound pressure)	ISE20B-L (Positive pressure)
<b>Applicable fluid</b>		Air, Non-corrosive gas, Non-flammable gas		
<b>Pressure</b>	<b>Rated pressure range</b>	0.0 to -101.0 kPa	-100.0 to 100.0 kPa	-0.100 to 1.000 MPa
	<b>Display/Set pressure range</b>	10.0 to -105.0 kPa	-105.0 to 105.0 kPa	-0.105 to 1.050 MPa
	<b>Display/Smallest settable increment</b>	0.1 kPa		0.001 MPa
	<b>Withstand pressure</b>	500 kPa		1.5 MPa
<b>Power supply</b>	<b>Power supply voltage</b>	12 to 24 VDC ±10% with 10% voltage ripple or less		
		When used as a switch output device (When not used as an IO-Link device)		
		When used as an IO-Link device		
	<b>Current consumption</b>	35 mA or less		
	<b>Protection</b>	Polarity protection		
<b>Accuracy</b>	<b>Display accuracy</b>	±2% F.S. ±1 digit (Ambient temperature of 25 ±3°C)		
	<b>Repeatability</b>	±0.2% F.S. ±1 digit		
	<b>Temperature characteristics</b>	±2% F.S. (25°C standard)		
<b>Switch output (SIO mode)</b>	<b>Output type</b>	Select from NPN or PNP open collector output.		
	<b>Output mode</b>	Hysteresis, Window comparator, Error output, Output OFF		
	<b>Switch operation</b>	Normal output, Reversed output		
	<b>Max. load current</b>	80 mA		
	<b>Max. applied voltage</b>	30 V (NPN output)		
	<b>Internal voltage drop (Residual voltage)</b>	1.5 V or less (at load current of 80 mA)		
	<b>Delay time*1</b>	1.5 ms or less, variable from 0 to 60 s/0.01 s increments		
	<b>Hysteresis</b>	Variable from 0*2		
		Window comparator mode		
		<b>Short circuit protection</b>	Yes	
<b>Display</b>	<b>Unit*3</b>	MPa, kPa, kgf/cm <sup>2</sup> , bar, psi, inHg, mmHg		MPa, kPa, kgf/cm <sup>2</sup> , bar, psi
	<b>Display type</b>	LCD		
	<b>Number of screens</b>	3-screen display (Main screen, Sub screen x 2)		
	<b>Display color</b>	Main screen: Red/Green, Sub screen: Orange		
	<b>Number of display digits</b>	Main screen: 4 digits (7 segments), Sub screen: 4 digits (Upper 1 digit 11 segments, 7 segments for other)		
	<b>Indicator light</b>	Lights up when switch output is turned ON (OUT1, OUT2: Orange)		
<b>Digital filter*4</b>		Variable from 0 to 30 s/0.01 s increments		
<b>Length of lead wire with connector</b>		2 m		
<b>Environmental resistance</b>	<b>Enclosure</b>	IP65		
	<b>Withstand voltage</b>	1000 VAC for 1 minute between terminals and housing		
	<b>Insulation resistance</b>	50 MΩ or more (500 VDC measured via megohmmeter) between terminals and housing		
	<b>Operating temperature range</b>	Operating: -5 to 50°C, Stored: -10 to 60°C (No condensation or freezing)		
	<b>Operating humidity range</b>	Operating/Stored: 35 to 85% RH (No condensation)		
<b>Standards</b>		CE/UKCA marking		
<b>Communication (IO-Link mode)</b>	<b>IO-Link type</b>	Device		
	<b>IO-Link version</b>	V1.1		
	<b>Communication speed</b>	COM2 (38.4 kbps)		
	<b>Configuration file</b>	IODD file*5		
	<b>Minimum cycle time</b>	2.3 ms		
	<b>Process data length</b>	Input data: 2 bytes, Output data: 0 bytes		
	<b>On request data communication</b>	Yes		
	<b>Data storage function</b>	Yes		
	<b>Event function</b>	Yes		
	<b>Vendor ID</b>	131 (0 x 0083)		

\*1 Value without digital filter (at 0 ms)

\*2 If the applied pressure fluctuates around the set value, the hysteresis must be set to a value greater than the amount of fluctuation, or chattering will occur.

\*3 Setting is only possible for models with the units selection function. Only MPa or kPa is available for models without this function.

\*4 The response time indicates when the set value is 90% in relation to the step input.

\*5 The configuration file can be downloaded from the SMC website, <https://www.smcworld.com>

\* Products with tiny scratches, marks, or display color or brightness variations which do not affect the performance of the product are verified as conforming products.

## Piping Specifications and Weights

Model		M5	01	N01
<b>Port size</b>		M5 x 0.8	R1/8	NPT1/8
<b>Materials of parts in contact with fluid</b>	<b>Sensor pressure receiving area</b>	Silicon		
	<b>Piping port (Common)</b>	PBT, CB156, Heat-resistant PPS, O-ring: HNBR		
	<b>Piping port</b>	—	C3604 (Electroless nickel plating), Stainless steel 304, NBR	
<b>Weight</b>	<b>Body</b>	24 g	34 g	36 g
	<b>Lead wire with connector</b>	+39 g		
	<b>M12 connector type</b>	43 g	53 g	55 g

## Cable Specifications

<b>Conductor cross section</b>		0.15 mm <sup>2</sup> (AWG26)
<b>Insulator</b>	<b>O.D.</b>	1.0 mm
	<b>Color</b>	Brown, Blue, Black, White, Gray (5-core)
<b>Sheath</b>	<b>Finished O.D.</b>	ø3.5

"Set Pressure Range and Rated Pressure Range," "Functions" → p. 17  
"Internal Circuits and Wiring Examples" → p. 19 "Dimensions" → From p. 20

ZSE20(F)  
ISE20

ZSE20A(F)  
ISE20A

ZSE20B(F)  
ISE20B

ZSE20B(F)-L  
ISE20B-L

ZSE20C(F)  
ISE20C(H)

ZSE20C(F)-L  
ISE20C(H)-L

Function  
Details

Made to  
Order

# ZSE20□(F)/ISE20□ Series

## Set Pressure Range and Rated Pressure Range

Set the pressure within the rated pressure range.

The set pressure range is the range of pressure within which setting is possible. The rated pressure range is the range of pressure that satisfies the specifications (accuracy, linearity, etc.) of the switch. Although it is possible to set a value outside the rated pressure range, the specifications cannot be guaranteed even if the value stays within the set pressure range.

Switch	Pressure range				
	-100 kPa	0	100 kPa	500 kPa	1 MPa
For vacuum pressure ZSE20 ZSE20A ZSE20B ZSE20B-L	-101 kPa	0	10 kPa		
For compound pressure ZSE20F ZSE20AF ZSE20BF ZSE20BF-L	-100 kPa		100 kPa		
For positive pressure ISE20 ISE20A ISE20B ISE20B-L	-100 kPa				1 MPa
	-105 kPa				1.05 MPa
	(-0.105 MPa)				

Rated pressure range of the switch      Set pressure range of the switch

## Analog Output<sup>\*1</sup>

### Voltage output

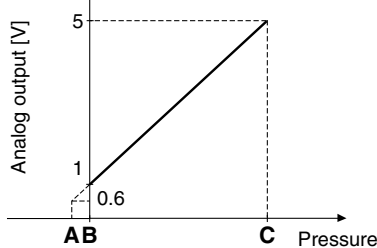

### Current output

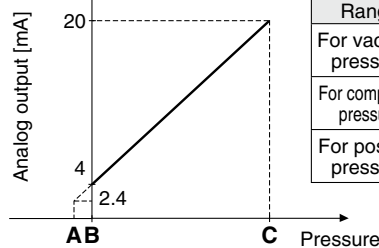

Range	Rated pressure range	A	B	C
For vacuum pressure	0.0 to -101.0 kPa	10.1 kPa	0	-101.0 kPa
For compound pressure	-100.0 to 100.0 kPa	—	-100.0 kPa	100.0 kPa
For positive pressure	-0.100 to 1.000 MPa	-0.100 MPa	0	1.000 MPa

\*1 Excluding the 20/20B(F)-L

## IO-Link: Process Data

### Relationship between the process data and pressure value

#### ZSE20B-L (For vacuum pressure)

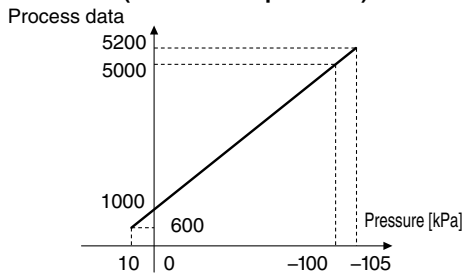

#### ZSE20BF-L (For compound pressure)

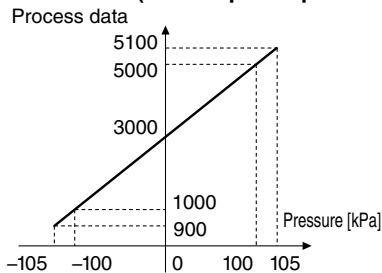

#### ISE20B-L (For positive pressure)

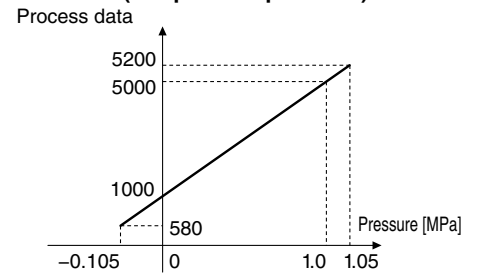

## Functions

Sub screen setting function	The display of the sub screen can be selected.
Auto-preset function	This function calculates a rough set value automatically based on the on-going operation.
Display value fine adjustment function	Evens out deviations in the displayed value
Peak value indication function	Can retain the maximum pressure value displayed during measurement
Bottom value indication function	Can retain the minimum pressure value displayed during measurement
Key-lock function (Selectable security code)	The keyboard can be locked to prevent the accidental operation of the operation switch.
Zero-clear function	The pressure display can be set to zero when the pressure is open to the atmosphere.
Error indication function	This function displays the error location and content when a problem or error has occurred.
Anti-chattering function	Prevents possible malfunctions due to sudden fluctuations in the primary pressure by adjusting the delay time
Units selection function	Can convert the display value
Power saving mode	Reduces power consumption
Display resolution switch function	Converts the display resolution from the normal value of 1/1000 to 1/100 Can reduce flickering of the monitor
kPa ↔ MPa switch function	Converts the unit between kPa and MPa
Copy function <sup>*1</sup>	The settings of the copy source can be copied to the copy destination.
Auto-shift function <sup>*1</sup>	Measures the pressure at the time of external input and uses it as a reference to correct the set value of the switch

\*1 Not available for the 20/20B-L

**Internal Circuits and Wiring Examples**

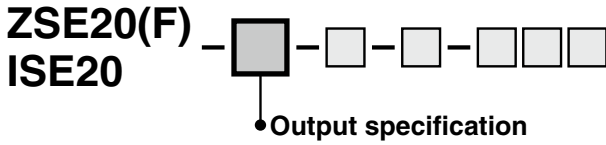

**-N**  
**NPN (1 output)**

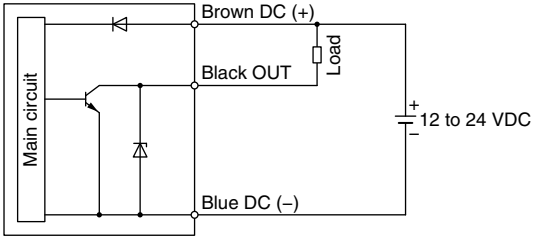

**-P**  
**PNP (1 output)**

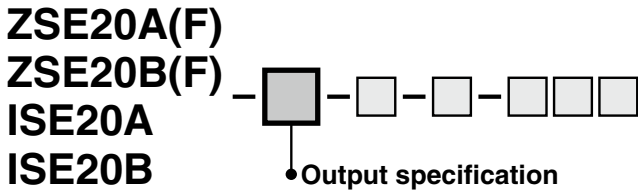
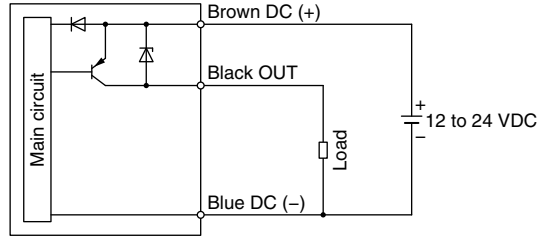

**-X**  
**NPN (2 outputs) + Copy function**

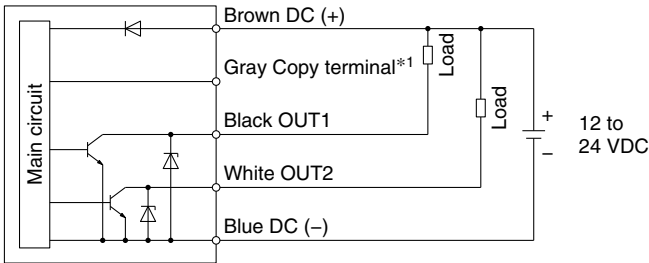

**-Y**  
**PNP (2 outputs) + Copy function**

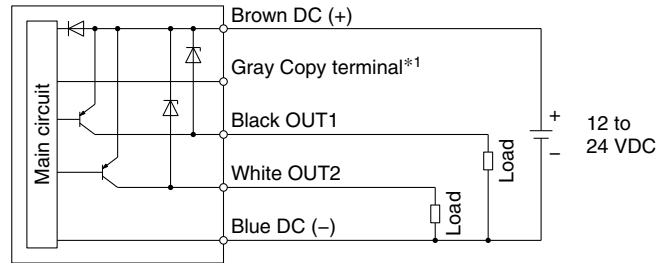

**-R: NPN (2 outputs) + Analog voltage output**  
**-S: NPN (2 outputs) + Analog current output**

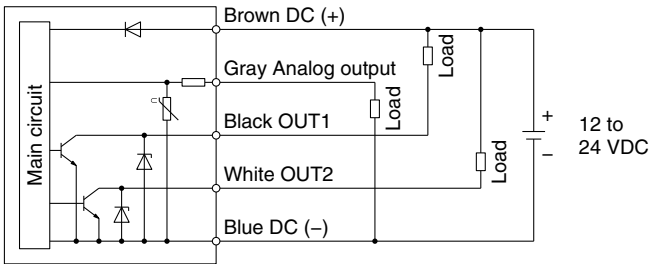

**-T: PNP (2 outputs) + Analog voltage output**  
**-V: PNP (2 outputs) + Analog current output**

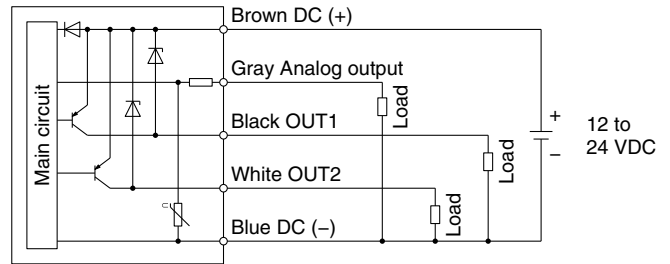

\*1 Refer to page 41.

ZSE20(F)  
ISE20

ZSE20A(F)  
ISE20A

ZSE20B(F)  
ISE20B

ZSE20B(F)-L  
ISE20B-L

ZSE20C(F)  
ISE20C(H)

ZSE20C(F)-L  
ISE20C(H)-L

Function  
Details

Made to  
Order

# ZSE20□(F)/ISE20□ Series

## Internal Circuits and Wiring Examples

### ZSE20A(F)

### ZSE20B(F)

### ISE20A

### ISE20B

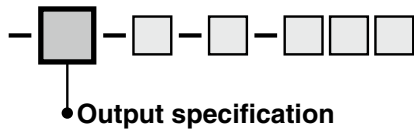

**-R: NPN (2 outputs) + Auto-shift input**

**-S: NPN (2 outputs) + Auto-shift input**

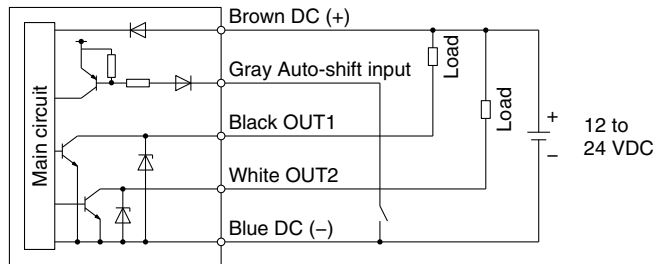

**-T: PNP (2 outputs) + Auto-shift input**

**-V: PNP (2 outputs) + Auto-shift input**

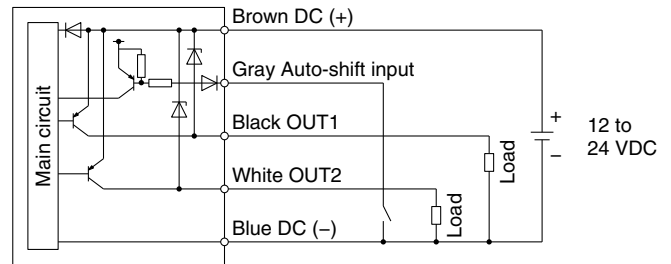

**-R: NPN (2 outputs) + Copy function**

**-S: NPN (2 outputs) + Copy function**

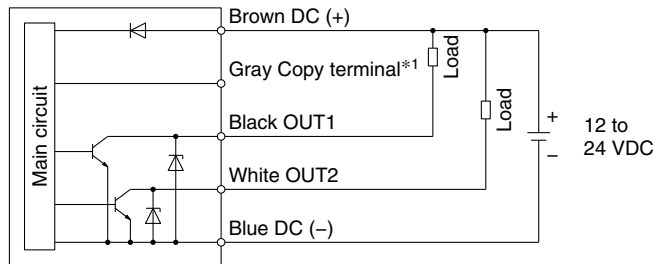

**-T: PNP (2 outputs) + Copy function**

**-V: PNP (2 outputs) + Copy function**

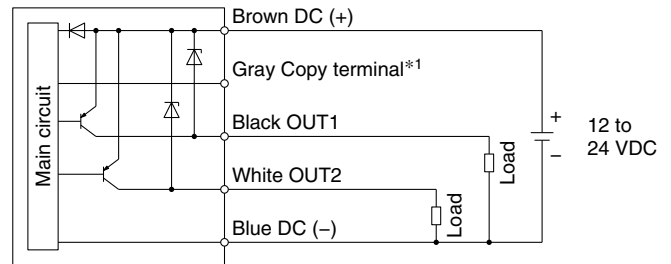

\*1 Refer to page 41.

### ZSE20B(F)

### ISE20B

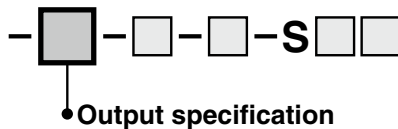

\* The numbers in the circuit diagram indicate the connector pin numbers.

**-X  
NPN (2 outputs)**

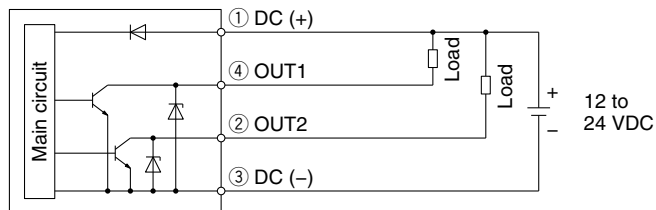

**-Y  
PNP (2 outputs)**

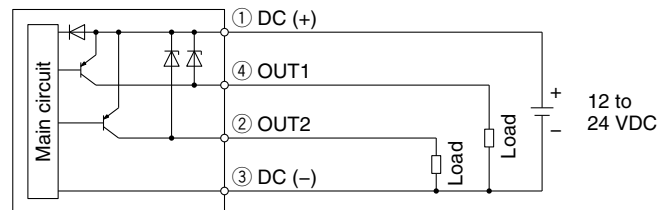

**-R: NPN (1 output) + Analog voltage output**

**-S: NPN (1 output) + Analog current output**

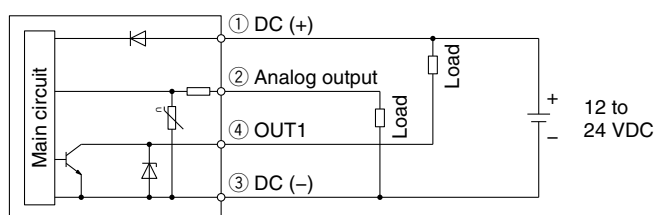

**-T: PNP (1 output) + Analog voltage output**

**-V: PNP (1 output) + Analog current output**

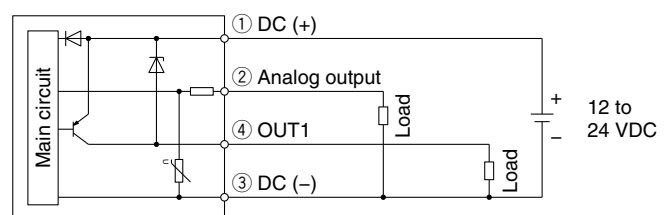



**Internal Circuits and Wiring Examples**

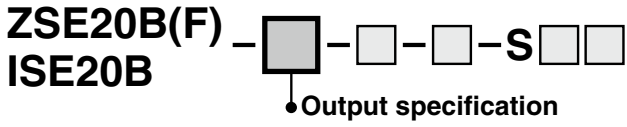

**-R: NPN (1 output) + Auto-shift input**  
**-S: NPN (1 output) + Auto-shift input**

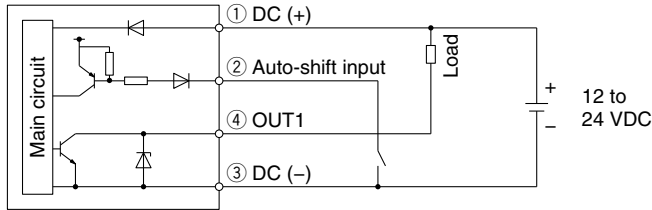

**-T: PNP (1 output) + Auto-shift input**  
**-V: PNP (1 output) + Auto-shift input**

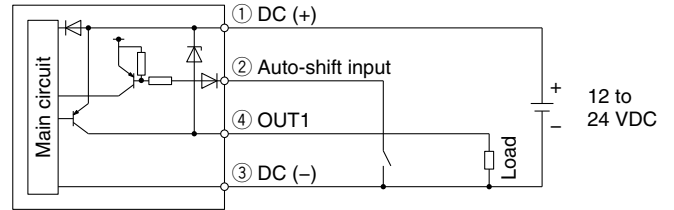

**-R: NPN (1 output) + Copy function**  
**-S: NPN (1 output) + Copy function**

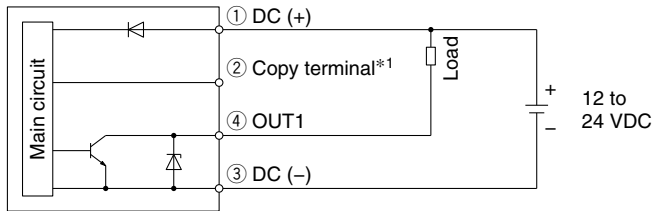

**-T: PNP (1 output) + Copy function**  
**-V: PNP (1 output) + Copy function**

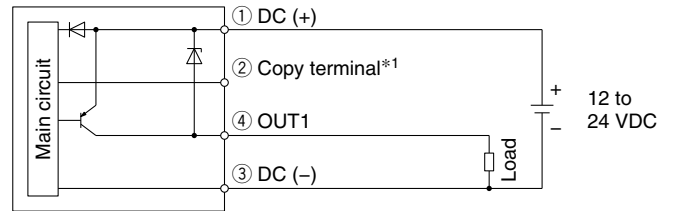

\* Refer to page 41.

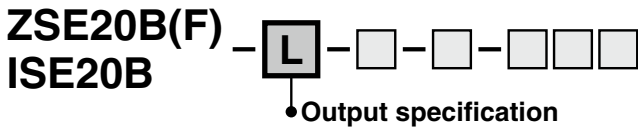

**-L: (IO-Link/Switch: 1 output)**

**When used as a switch output device (When not used as an IO-Link device = When in SIO mode)**

**NPN open collector 1 output setting**

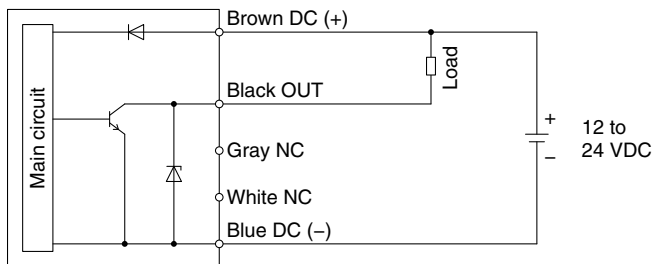

**PNP open collector 1 output setting**

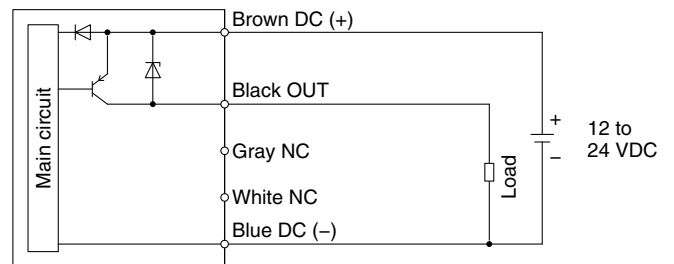

**When used as an IO-Link device**

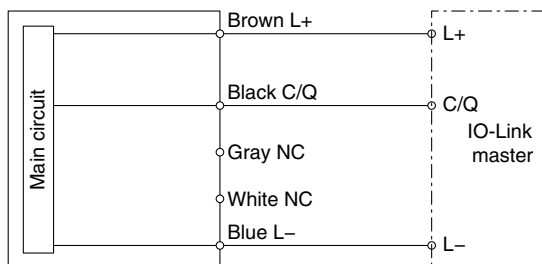

# ZSE20□(F)/ISE20□ Series

## Internal Circuits and Wiring Examples

ZSE20B(F) - **L** - □ - □ - S□□  
 ISE20B

\* The numbers in the circuit diagram indicate the connector pin numbers.

● Output specification

**-L: (IO-Link/Switch: 1 output)**

**When used as a switch output device (When not used as an IO-Link device = When in SIO mode)**

**NPN open collector 1 output setting**

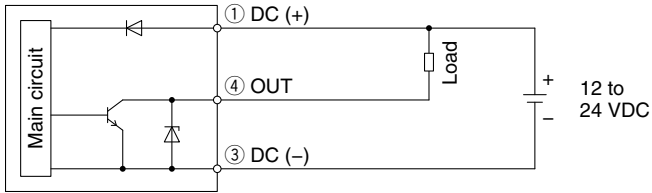

**PNP open collector 1 output setting**

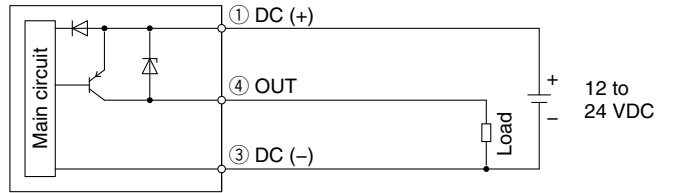

**When used as an IO-Link device**

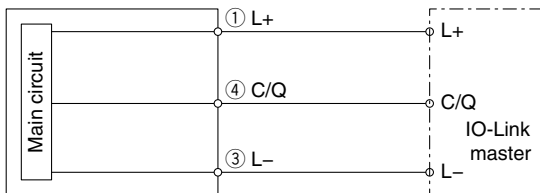

# 3-Screen Display High-Precision Digital Pressure Switch **ZSE20□(F)/ISE20□ Series**

## Dimensions

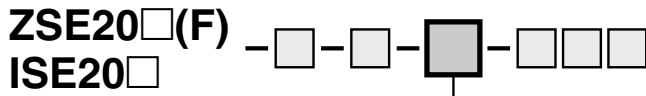

• Piping specification

**M5**  
M5 female thread

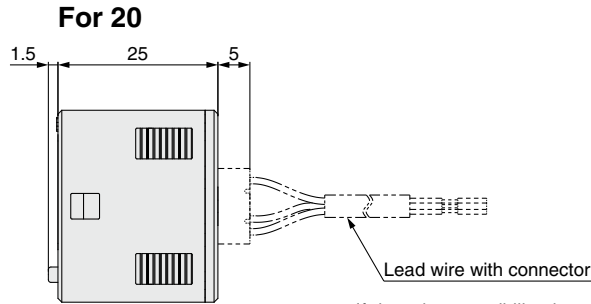

If there is a possibility that the atmospheric vent port of the switch will be exposed to water or dust, insert a tube into the atmospheric vent port and route the other end of the tube to a safe place away from water or dust. (Z/ISE20B)  
\* For tubing, please use the SMC TU0425 (polyurethane, O.D. ø4, I.D. ø2.5) for the pressure switch.

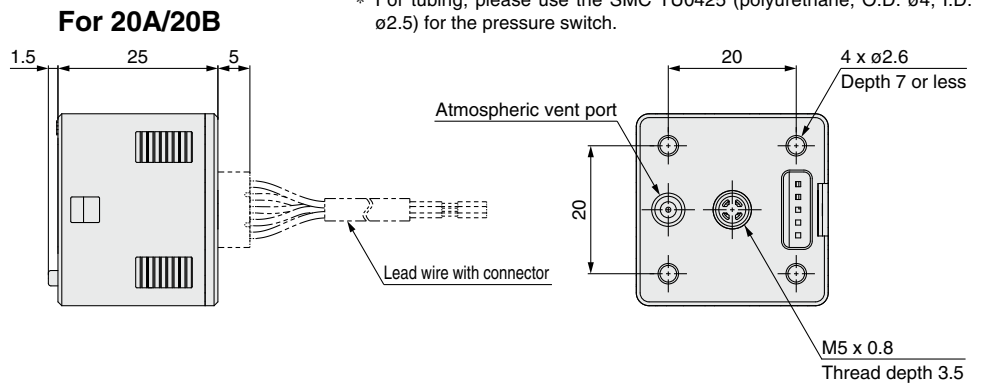
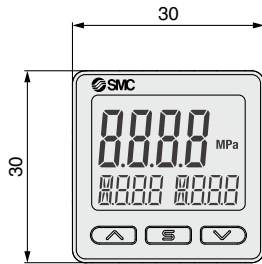

**01**  
R1/8

**N01**  
NPT1/8

Piping specification	Port size	A
01	R1/8	Width across flats 10
N01	NPT1/8	Width across flats 12

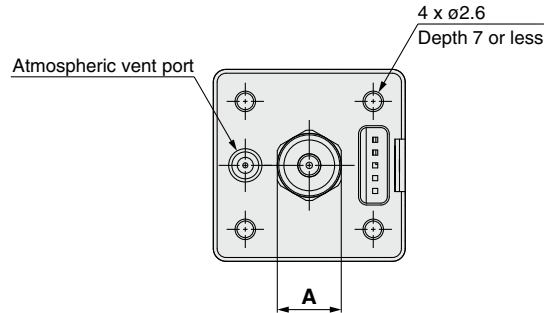
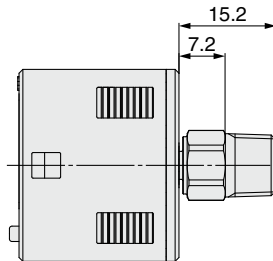

**C4H, C6H, N7H**

One-touch fitting Straight type  
ø4 mm, ø6 mm, ø1/4 inch

Piping specification	A	B
C4H	15.6	ø8
C6H	16.5	ø10
N7H	16	ø10.3

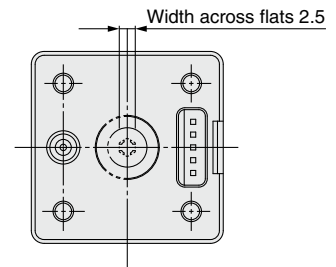
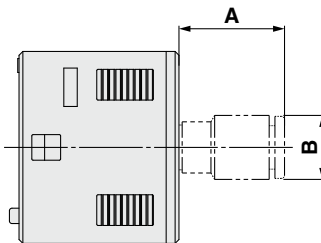

**C4L, C6L, N7L**

One-touch fitting Elbow type  
ø4 mm, ø6 mm, ø1/4 inch

Piping specification	A	B	C	D
C4L	15.2	17.5	4	ø8.2
C6L	15.2	18.3	4	ø10.4
N7L	20.9	20.6	6	ø11.1

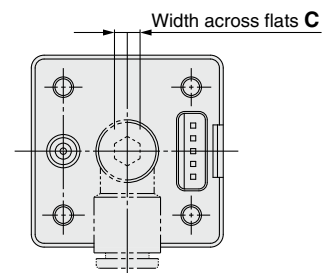
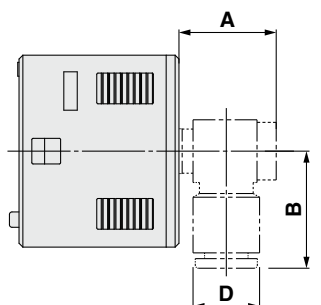

# ZSE20□(F)/ISE20□ Series

## Dimensions

ZSE20B(F) -□-□-□-**S**□□  
ISE20B

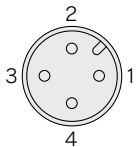
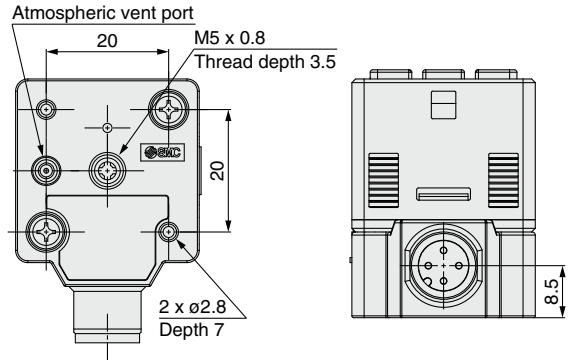
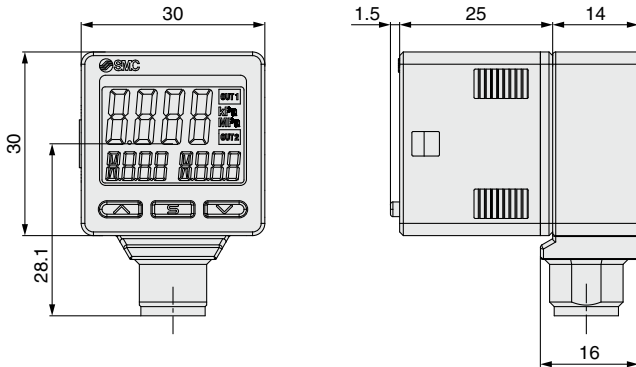

Body side plug connector pin assignment

Pin no.	Output specification		
	X, Y	R, S, T, V	L
1	DC (+)		
2	OUT (2)	FUNC	N.C.
3	DC (-)		
4	OUT (1)	OUT1 (C/Q)	

The M12 connector type has an internal waterproof seal that prevents the entry of water. However, if there is a possibility that the atmospheric vent port will be constantly exposed to water or dust, insert a tube (sold separately) all the way into the atmospheric vent port and route the other end of the tube to a safe place away from water or dust. (Z/ISE20B)  
\* For tubing, please use the SMC TU0425 (polyurethane, O.D.  $\phi 4$ , I.D.  $\phi 2.5$ ) for the pressure switch.

### Lead wire with M12 connector, Straight (Part no.: ZS-37-A)

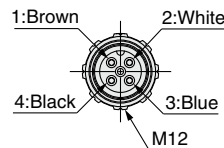
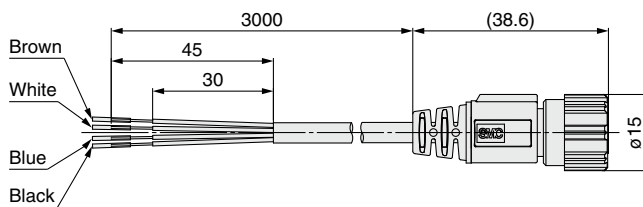

#### Cable Specifications

Conductor	Nominal cross section	AWG23
	Outside diameter	0.72 mm
Insulator	Material	Cross-linked vinyl
	Outside diameter	1.14 mm
	Number of cores	4
Sheath	Material	Oil-resistant vinyl
	Finished outside diameter	$\phi 4$

### Lead wire with M12 connector, Straight (Part no.: ZS-31-B)

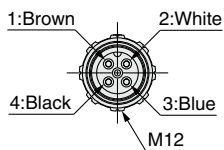
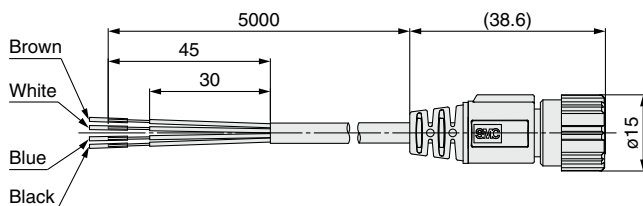

#### Cable Specifications

Conductor	Nominal cross section	AWG23
	Outside diameter	0.72 mm
Insulator	Material	Cross-linked vinyl
	Outside diameter	1.14 mm
	Number of cores	4
Sheath	Material	Oil-resistant vinyl
	Finished outside diameter	$\phi 4$

## Dimensions

### Lead wire with M12 connector, Right-angle (Part no.: ZS-37-B)

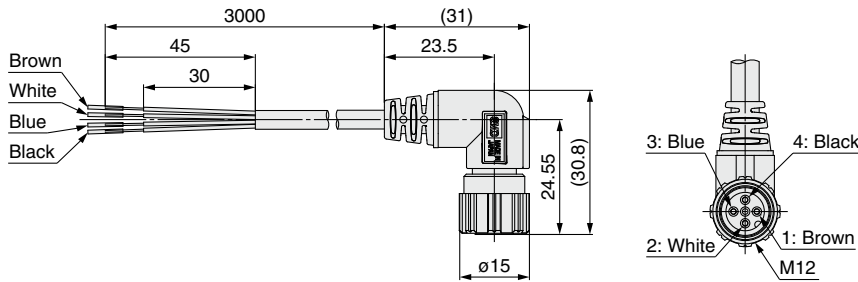

### Cable Specifications

Conductor	Nominal cross section	AWG23
	Outside diameter	0.72 mm
Insulator	Material	Cross-linked vinyl
	Outside diameter	1.14 mm
	Number of cores	4
Sheath	Material	Oil-resistant vinyl
Finished outside diameter		ø4

### Lead wire with M12 connector, Right-angle (Part no.: ZS-31-C)

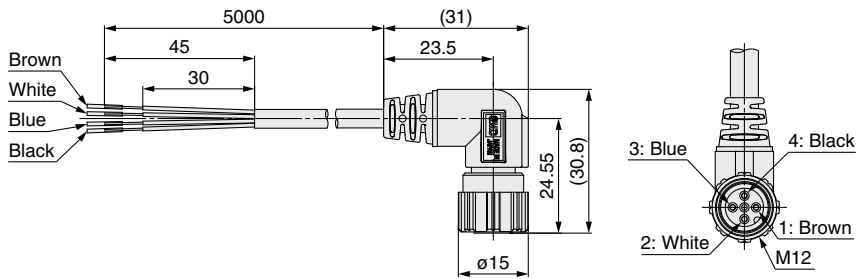

### Cable Specifications

Conductor	Nominal cross section	AWG23
	Outside diameter	0.72 mm
Insulator	Material	Cross-linked vinyl
	Outside diameter	1.14 mm
	Number of cores	4
Sheath	Material	Oil-resistant vinyl
Finished outside diameter		ø4

### Lead wire and M12 connector (Connector on both sides)

#### EX9-AC 005 -SSPS (With connector on both sides (Socket/Plug))

##### ● Cable length (L)

005	500 mm
010	1000 mm
020	2000 mm
030	3000 mm
050	5000 mm
100	10000 mm

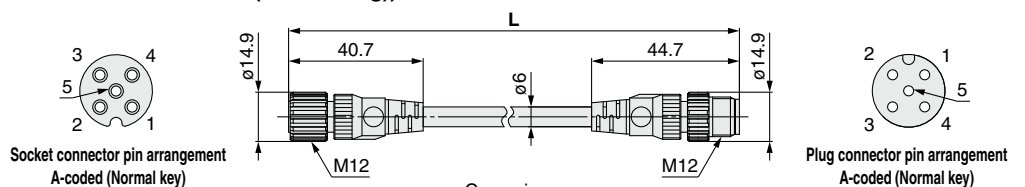

##### Terminal no.

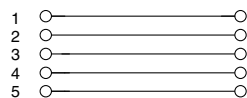

##### Core wire color

- 1 Brown
- 2 White
- 3 Blue
- 4 Black
- 5 Gray

##### Connections

Item	Specifications
Cable O.D.	ø6 mm
Conductor nominal cross section	0.3 mm <sup>2</sup> /AWG22
Wire O.D. (Including conductor)	1.5 mm
Min. bending radius (Fixed)	40 mm

# ZSE20□(F)/ISE20□ Series

## Dimensions

With bracket

ZSE20□(F) — □ — □ — □ — □ — □ — □  
 ISE20□

• Option 2

### A1

Bracket A  
 (Part no.: ZS-46-A1)

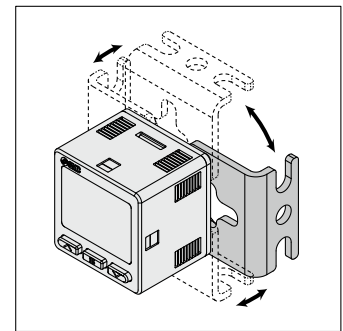
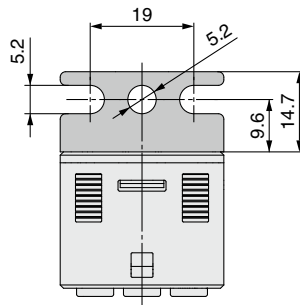
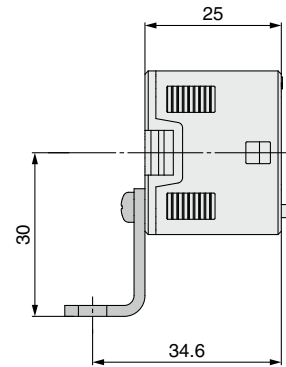
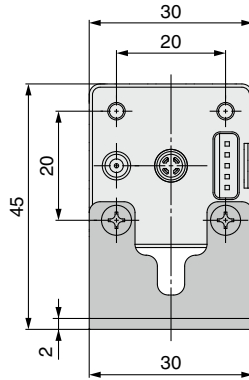

\* The bracket configuration allows for mounting in four orientations.

### A2

Bracket B  
 (Part no.: ZS-46-A2)

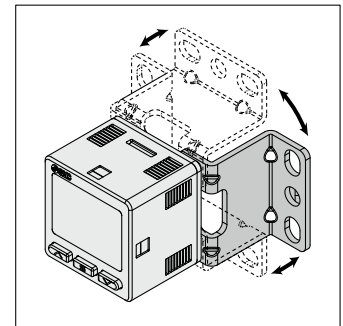
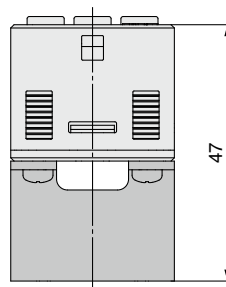

\* The bracket configuration allows for mounting in four orientations.

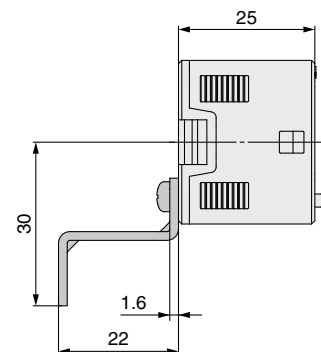
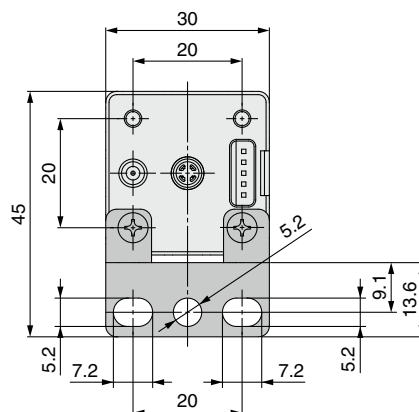

\* When using the bracket B, install it by taking the dimensions of the piping part into consideration.

**Dimensions**

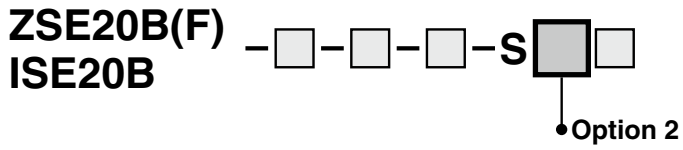

**A4**

**Bracket D (For M12 connector type)**  
 (Part no.: ZS-46-A4)

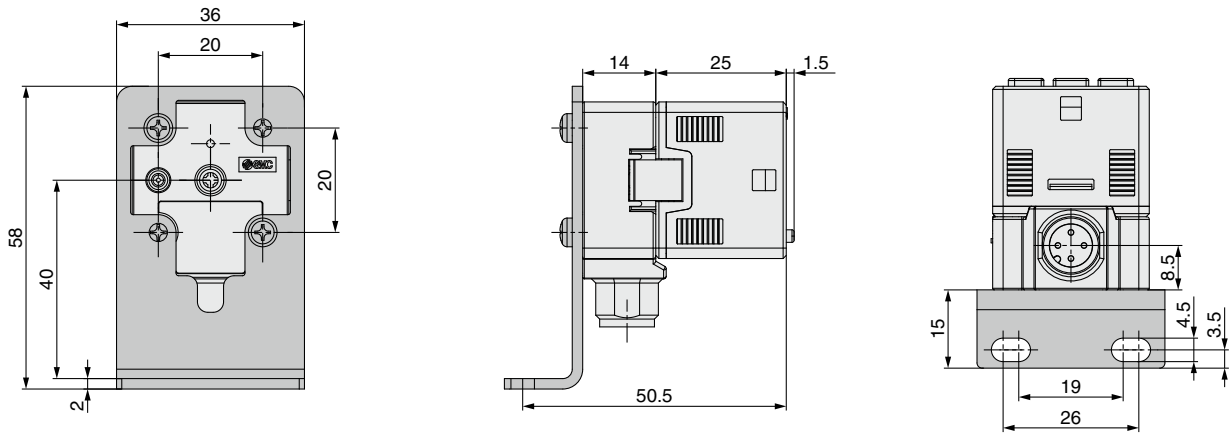

**A5**

**Bracket E (For M12 connector type)**  
 (Part no.: ZS-46-A5)

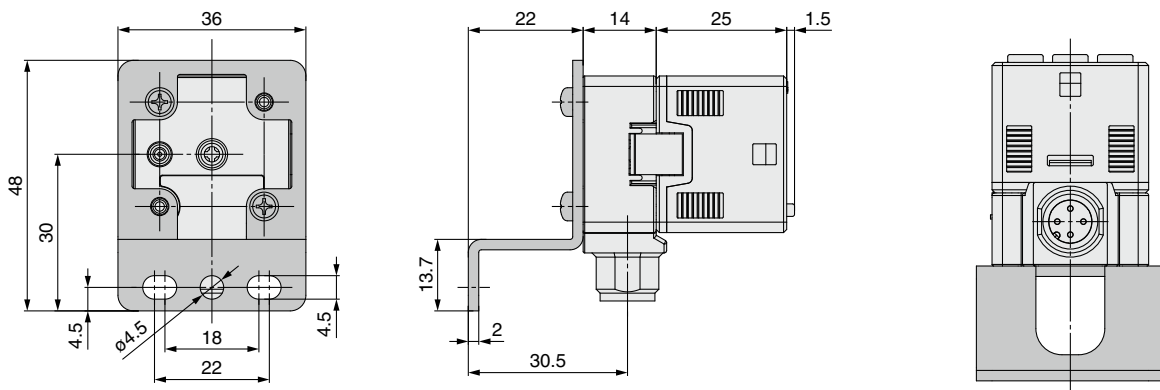





## Dimensions

### Panel mount adapter

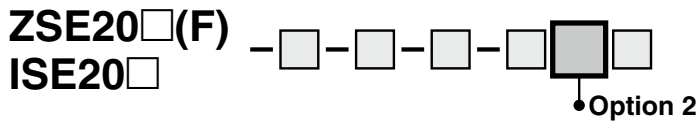

### **B** Panel mount adapter (Part no.: ZS-46-B)

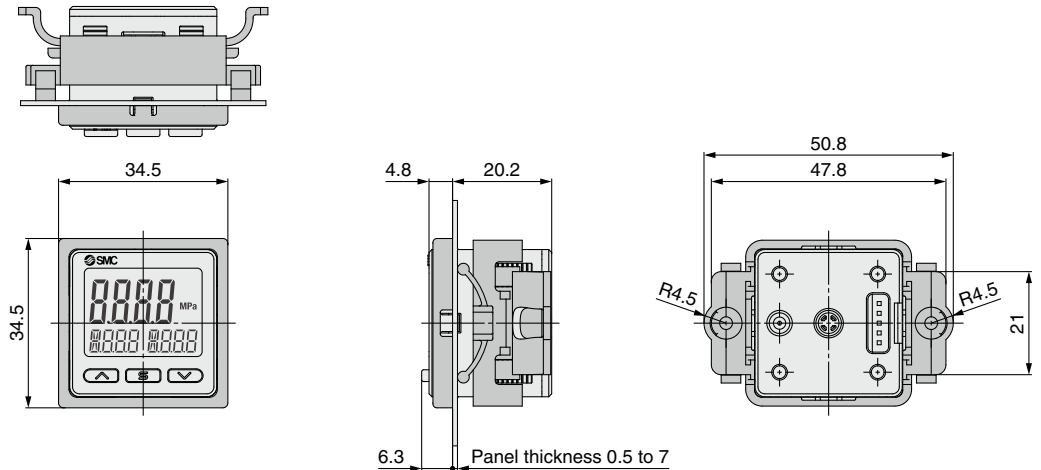

### **D** Panel mount adapter + Front protection cover (Part no.: ZS-46-D)

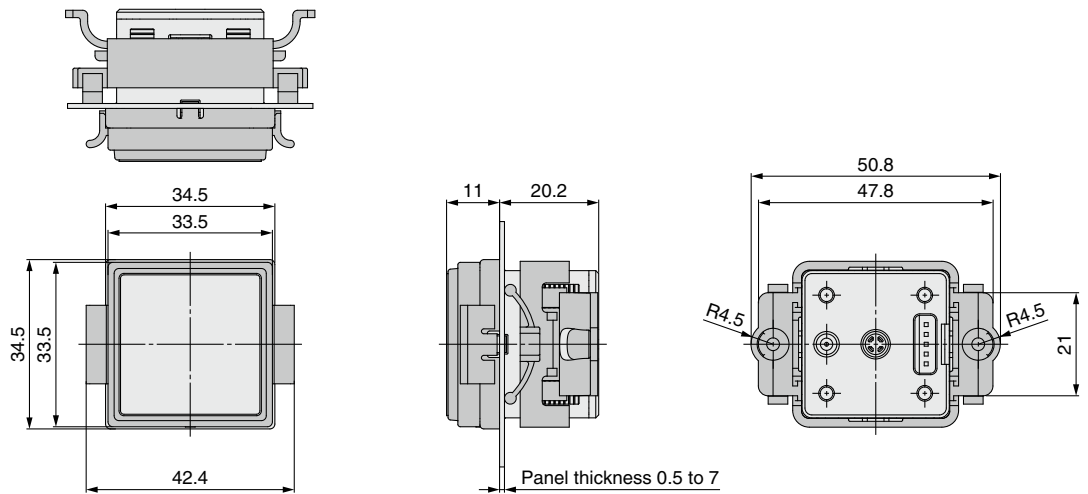

### Lead wire with connector

#### For Z/ISE20(F) (Part no.: ZS-46-3L)

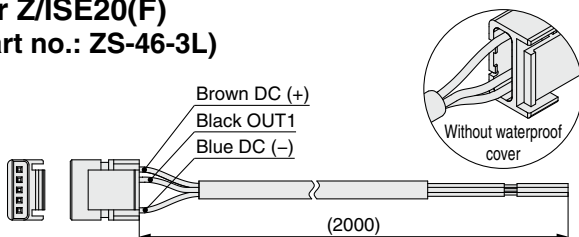

#### For Z/ISE20A(F) (Part no.: ZS-46-5L)

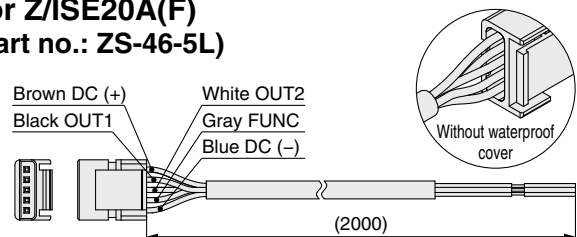

#### For Z/ISE20B(F)(-L) (Part no.: ZS-46-5F)

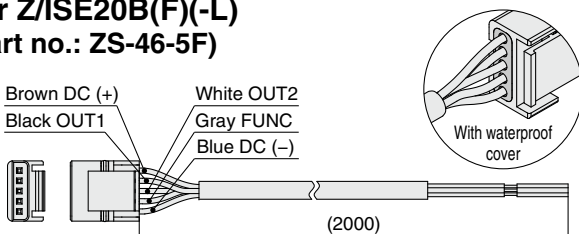

\* For the lead wire with M12 connector, refer to page 43.

# ZSE20□(F)/ISE20□ Series

## Dimensions

### Panel fitting dimensions

#### Individual mounting

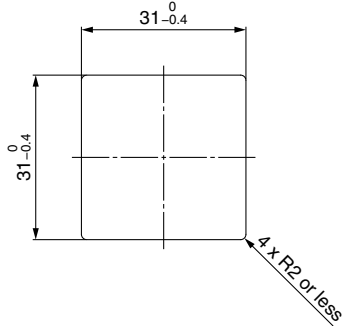

#### Multiple (2 pcs. or more) secure mounting <Horizontal>

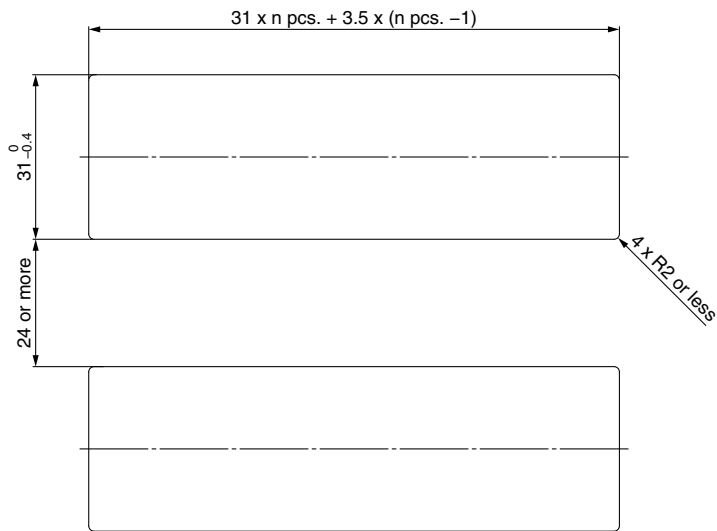

#### Panel mount example <Horizontal>

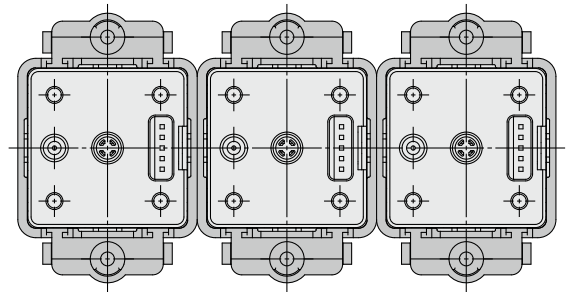

#### <Vertical>

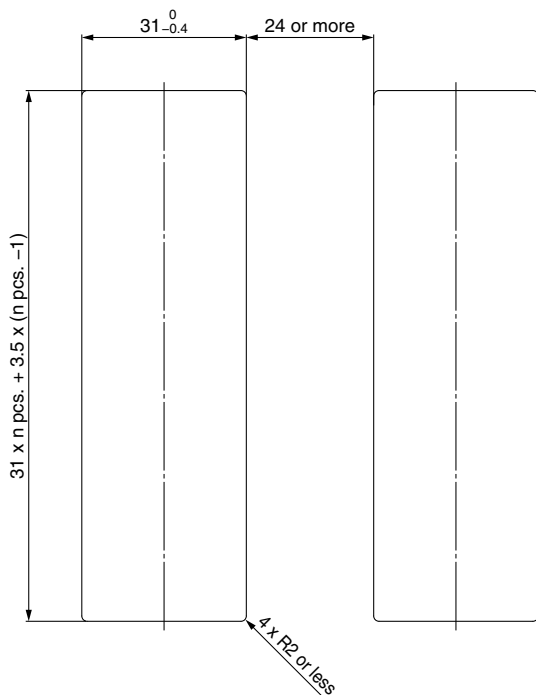

#### Panel mount example <Vertical>

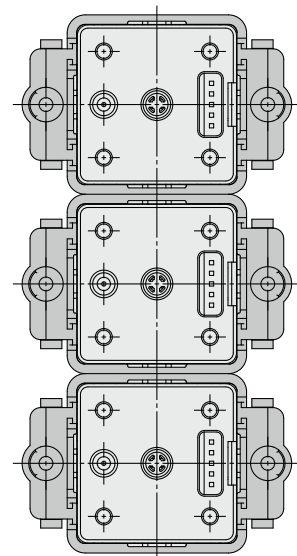

Made to  
Order

Function  
Details

ZSE20C(F)-L  
ISE20C(H)-L

ZSE20C(F)  
ISE20C(H)

ZSE20B(F)-L  
ISE20B-L

ZSE20B(F)  
ISE20B

ZSE20A(F)  
ISE20A

ZSE20(F)  
ISE20

2 Outputs + Analog Output (Voltage/Current)



# 3-Screen Display High-Precision Digital Pressure Switch for General Fluids

RoHS

IP65

# ZSE20C(F)/ISE20C(H) Series

For the IO-Link compatible type, refer to page 27.

## How to Order



### Rated pressure range

ISE20C	-0.1 to 1 MPa
ISE20CH	-0.1 to 2 MPa

For Positive Pressure

**ISE20C** - **X** - **M** - **02** [ ] - [ ] - [ ] - [ ]

For Vacuum/Compound Pressure

**ZSE20C** - **X** - **M** - **02** [ ] - [ ] - [ ] - [ ]

① ② ③ ④ ⑤ ⑥ ⑦ ⑧ • Made to order (pp. 42 to 48)

### ① Rated pressure range

ZSE20C	0 to -101 kPa
ZSE20CF	-100 to 100 kPa

### ④ Piping specification

Symbol	Description
02	R1/4 (M5 female threaded)
N02	NPT1/4 (M5 female threaded)
F02	G1/4 (M5 female threaded)
C01	Rc1/8
A2	URJ1/4 (Face seal fitting)
B2	TSJ1/4 (Compression fitting)

### ⑤ Piping direction

Nil	Rear ported	
L	Bottom ported	

### ② Output specification

Symbol	Description
R	NPN open collector 2 outputs + Analog voltage output*1
S	NPN open collector 2 outputs + Analog current output*1
T	PNP open collector 2 outputs + Analog voltage output*1
V	PNP open collector 2 outputs + Analog current output*1
X	NPN open collector 2 outputs + Copy function
Y	PNP open collector 2 outputs + Copy function

\*1 Can be switched to auto-shift or copy function

### ③ Unit specification

Symbol	Description
Nil	Units selection function*2
M	SI units only*3
P	Units selection function (Initial value psi)*3

\*2 Under the New Measurement Act, switches with the units selection function are no longer allowed for use in Japan.

\*3 Fixed units: kPa, MPa

### ⑦ Option 2

\* Note that the optional parts that can be used vary depending on the piping direction.

Symbol	Description
Nil	None

### Rear ported (⑤ Piping direction: Nil)

Symbol	Description	Symbol	Description
A1	Bracket A	B	Panel mount adapter
D	Panel mount adapter + Front protection cover		ZS-46-D

### Bottom ported (⑤ Piping direction: L)

Symbol	Description
A3	Bracket C
E	Panel mount adapter
F	Panel mount adapter + Front protection cover

### ⑥ Option 1

Symbol	Description
Nil	Without lead wire
W	Lead wire with connector, 5-core (2 m lead wire, With waterproof cover)

\* For the lead wire with M12 connector, refer to page 43.

## Options/Part Nos.

When only optional parts are required, order with the part numbers listed below.

Description	Part no.	Note
Bracket A	ZS-46-A1	For rear ported/Tapping screw: Nominal size 3 x 8 L (2 pcs.)
Bracket C	ZS-46-E	For bottom ported/Tapping screw: Nominal size 3 x 10 L (2 pcs.)
Panel mount adapter	ZS-46-B	Rear ported
	ZS-35-B	Bottom ported
Panel mount adapter + Front protection cover	ZS-46-D	Rear ported
	ZS-35-E	Bottom ported
Panel mount adapter (Compatible with the panel holes of the ZISE80)	ZS-46-F	Rear ported, Made to order (Refer to page 46.)
Panel mount adapter + Front protection cover (Compatible with the panel holes of the ZISE80)	ZS-46-G	Rear ported, Made to order (Refer to page 46.)
Lead wire with connector	ZS-46-5F	5-core, 2 m, Waterproof (With waterproof cover)
Lead wire with M12 connector	ZS-46-5FM12	Made to order (Refer to page 43.)
Front protection cover	ZS-27-01	Rear ported
	ZS-35-01	Bottom ported
Adapter with restrictor Rc1/4	ZS-31-X175	To prevent the effects of water collision with inertia force Dimensions (Refer to page 32.)
Adapter with restrictor NPT1/4	ZS-31-X186	
Adapter with restrictor Rc1/8	ZS-31-X188	
Orifice M5	ZS-48-A	To prevent the effects of water collision with inertia force Dimensions (Refer to page 32.)

### ⑧ Option 3

Symbol	Operation manual*4	Calibration certificate*4
Nil	○	—
Y	—	—
K	○	○
T	—	○

\*4 All texts are in both English and Japanese.

# 3-Screen Display High-Precision Digital Pressure Switch for General Fluids **ZSE20C(F)/ISE20C(H) Series**

For pressure switch precautions and specific product precautions, refer to the "Operation Manual" on the SMC website.



## Specifications

Model		ZSE20C (Vacuum pressure)	ZSE20CF (Compound pressure)	ISE20C (Positive pressure)	ISE20CH (Positive pressure)	
<b>Applicable fluid</b>		Liquids and gases that do not corrode stainless steel 630 and 304				
<b>Pressure</b>	<b>Rated pressure range</b>	0.0 to -101.0 kPa	-100.0 to 100.0 kPa	-0.100 to 1.000 MPa	-0.100 to 2.000 MPa	
	<b>Display/Set pressure range</b>	10.0 to -105.0 kPa	-105.0 to 105.0 kPa	-0.105 to 1.050 MPa	-0.105 to 2.100 MPa	
	<b>Display/Smallest settable increment</b>	0.1 kPa		0.001 MPa		
	<b>Withstand pressure</b>	500 kPa		2 MPa	4 MPa	
<b>Power supply</b>	<b>Power supply voltage</b>	12 to 24 VDC ±10% with 10% voltage ripple or less				
	<b>Current consumption</b>	35 mA or less				
	<b>Protection</b>	Polarity protection				
<b>Accuracy</b>	<b>Display accuracy</b>	±2% F.S. ±1 digit (Ambient temperature of 25 ±3°C)				
	<b>Repeatability</b>	±0.2% F.S. ±1 digit				
	<b>Analog output accuracy</b>	±2.5% F.S. (Ambient temperature of 25 ±3°C)				
	<b>Analog output linearity</b>	±1% F.S.				
	<b>Temperature characteristics</b>	±3% F.S. (25°C standard)				
<b>Switch output</b>	<b>Output type</b>	NPN or PNP open collector 2 outputs				
	<b>Output mode</b>	Hysteresis mode, Window comparator mode, Error output, Output OFF				
	<b>Switch operation</b>	Normal output, Reversed output				
	<b>Max. load current</b>	80 mA				
	<b>Max. applied voltage (NPN only)</b>	28 V				
	<b>Internal voltage drop (Residual voltage)</b>	1 V or less (at load current of 80 mA)				
	<b>Delay time*1</b>	1.5 ms or less (with anti-chattering function: 20, 100, 500, 1000, 2000, 5000 ms)				
	<b>Hysteresis</b>	<b>Hysteresis mode</b>	Variable from 0*2			
		<b>Window comparator mode</b>				
<b>Short circuit protection</b>	Yes					
<b>Analog output</b>	<b>Voltage output</b>	<b>Output type</b>	Voltage output: 1 to 5 V	Voltage output: 0.6 to 5 V	Voltage output: 0.8 to 5 V	
		<b>Output impedance</b>	Approx. 1 kΩ			
	<b>Current output</b>	<b>Output type</b>	Current output: 4 to 20 mA	Current output: 2.4 to 20 mA	Current output: 3.2 to 20 mA	
		<b>Load impedance</b>	Maximum load impedance at power supply voltage of 12 V: 300 Ω at power supply voltage of 24 V: 600 Ω Minimum load impedance: 50 Ω			
<b>Auto-shift input</b>	<b>Input type</b>	Non-voltage input: 0.4 V or less				
	<b>Input mode</b>	Select from Auto-shift or Auto-shift zero.				
	<b>Input time</b>	5 ms or more				
<b>Display</b>	<b>Unit*3</b>	MPa, kPa, kgf/cm <sup>2</sup> , bar, psi, inHg, mmHg	MPa, kPa, kgf/cm <sup>2</sup> , bar, psi			
	<b>Display type</b>	LCD				
	<b>Number of screens</b>	3-screen display (Main screen, Sub screen x 2)				
	<b>Display color</b>	1) Main screen: Red/Green 2) Sub screen: Orange				
	<b>Number of display digits</b>	1) Main screen: 4 digits (7 segments) 2) Sub screen: 4 digits (Upper 1 digit 11 segments, 7 segments for other)				
	<b>Indicator light</b>	Lights up when switch output is turned ON (OUT1, OUT2: Orange)				
<b>Digital filter*4</b>	0, 10, 50, 100, 500, 1000, 5000 ms					
<b>Environmental resistance</b>	<b>Enclosure</b>	IP65				
	<b>Withstand voltage</b>	250 VAC for 1 minute between terminals and housing				
	<b>Insulation resistance</b>	2 MΩ or more (50 VDC measured via megohmmeter) between terminals and housing				
	<b>Operating temperature range</b>	Operating: -5 to 50°C, Stored: -10 to 60°C (No condensation or freezing)				
	<b>Operating humidity range</b>	Operating/Stored: 35 to 85% RH (No condensation)				
<b>Standards</b>	UL/CSA (E216656), CE/UKCA marking					
<b>Length of lead wire with connector</b>	2 m					

\*1 Value without digital filter (at 0 ms)

\*2 If the applied pressure fluctuates around the set value, the hysteresis must be set to a value greater than the amount of fluctuation, or chattering will occur.

\*3 Setting is only possible for models with the units selection function. Only MPa or kPa is available for models without this function.

\*4 The response time indicates when the set value is 90% in relation to the step input.

\* Products with tiny scratches, marks, or display color or brightness variations which do not affect the performance of the product are verified as conforming products.

### Piping Specifications and Weights

Model	02	N02	F02	C01	A2	B2	
<b>Port size</b>	R1/4	NPT1/4	G1/4	Rc1/8	URJ1/4	TSJ1/4	
<b>Materials of parts in contact with fluid</b>	Pressure sensor: Stainless steel 630, Fitting: Stainless steel 304, Grease-free						
<b>Weight</b>	<b>Body (Rear ported)</b>	51 g	51 g	48 g	47 g	54 g	46 g
	<b>Body (Bottom ported)</b>	77 g	78 g	74 g	65 g	81 g	72 g
	<b>Lead wire with connector</b>	+39 g					

### Cable Specifications

<b>Conductor cross section</b>	0.15 mm <sup>2</sup> (AWG26)	
<b>Insulator</b>	<b>O.D.</b>	1.0 mm
	<b>Color</b>	Brown, Blue, Black, White, Gray (5-core)
<b>Sheath</b>	<b>Finished O.D.</b>	ø3.5

ZSE20(F)  
ISE20

ZSE20A(F)  
ISE20A

ZSE20B(F)  
ISE20B

ZSE20B(F)-L  
ISE20B-L

ZSE20C(F)  
ISE20C(H)

ZSE20C(F)-L  
ISE20C(H)-L

Function  
Details

Made to  
Order

IO-Link Compatible (1 Output)



RoHS

IP65

3-Screen Display High-Precision

Digital Pressure Switch for General Fluids

# ZSE20C(F)-L/ISE20C(H)-L Series

For 2 outputs + analog output type, refer to page 25.

## How to Order



### Rated pressure range

ISE20C	-0.1 to 1 MPa
ISE20CH	-0.1 to 2 MPa

For Positive Pressure

ISE20C - L - M - 02

For Vacuum/  
Compound Pressure

ZSE20C - L - M - 02

① ② ③ ④ ⑤ ⑥ ⑦ ⑧

### ① Rated pressure range

ZSE20C	0 to -101 kPa
ZSE20CF	-100 to 100 kPa

### ② Output specification

Symbol	Description
L	IO-Link/Switch: 1 output ← (PNP or NPN switching type for switch output)

### ⑦ Option 2

\* Note that the optional parts that can be used vary depending on the piping direction.

Symbol	Description
Nil	None

### ③ Unit specification

Symbol	Description
Nil	Units selection function*1
M	SI units only*2
P	Units selection function (Initial value psi)*1

\*1 Under the New Measurement Act, switches with the units selection function are no longer allowed for use in Japan.

\*2 Fixed units: kPa, MPa

### ④ Piping specification

Symbol	Description
02	R1/4 (M5 female threaded)
N02	NPT1/4 (M5 female threaded)
F02	G1/4 (M5 female threaded)
C01	Rc1/8
A2	URJ1/4 (Face seal fitting)
B2	T SJ1/4 (Compression fitting)

### Rear ported (⑤ Piping direction: Nil)

Symbol	Description	Symbol	Description
A1	Bracket A	B	Panel mount adapter
D	Panel mount adapter + Front protection cover		

### Bottom ported (⑤ Piping direction: L)

Symbol	Description
A3	Bracket C
E	Panel mount adapter
F	Panel mount adapter + Front protection cover

### ⑤ Piping direction

Nil	Rear ported
L	Bottom ported

### ⑥ Option 1

Symbol	Description
Nil	Without lead wire
W	Lead wire with connector, 5-core (2 m lead wire, With waterproof cover)

\* For the lead wire with M12 connector, refer to page 43.

## Options/Part Nos.

When only optional parts are required, order with the part numbers listed below.

Description	Part no.	Note
Bracket A	ZS-46-A1	For rear ported/Tapping screw: Nominal size 3 x 8 L (2 pcs.)
Bracket C	ZS-46-E	For bottom ported/Tapping screw: Nominal size 3 x 10 L (2 pcs.)
Panel mount adapter	ZS-46-B	Rear ported
	ZS-35-B	Bottom ported
Panel mount adapter + Front protection cover	ZS-46-D	Rear ported
	ZS-35-E	Bottom ported
Lead wire with connector	ZS-46-5F	5-core, 2 m, Waterproof (With waterproof cover)
Lead wire with M12 connector	ZS-46-5FM12	Made to order (Refer to page 43.)
Front protection cover	ZS-27-01	Rear ported
	ZS-35-01	Bottom ported
Adapter with restrictor Rc1/4	ZS-31-X175	To prevent the effects of water collision with inertia force Dimensions (Refer to page 32.)
Adapter with restrictor NPT1/4	ZS-31-X186	
Adapter with restrictor Rc1/8	ZS-31-X188	
Orifice M5	ZS-48-A	To prevent the effects of water collision with inertia force Dimensions (Refer to page 32.)

### ⑧ Option 3

Symbol	Operation manual*3	Calibration certificate*3
Nil	○	—
Y	—	—
K	○	○
T	—	○

\*3 All texts are in both English and Japanese.

For pressure switch precautions and specific product precautions, refer to the "Operation Manual" on the SMC website.



## Specifications

Model		ZSE20C-L (Vacuum pressure)	ZSE20CF-L (Compound pressure)	ISE20C-L (Positive pressure)	ISE20CH-L (Positive pressure)	
<b>Applicable fluid</b>		Liquids and gases that do not corrode stainless steel 630 and 304				
<b>Pressure</b>	<b>Rated pressure range</b>	0.0 to -101.0 kPa	-100.0 to 100.0 kPa	-0.100 to 1.000 MPa	-0.100 to 2.000 MPa	
	<b>Display/Set pressure range</b>	10.0 to -105.0 kPa	-105.0 to 105.0 kPa	-0.105 to 1.050 MPa	-0.105 to 2.100 MPa	
	<b>Display/Smallest settable increment</b>	0.1 kPa		0.001 MPa		
	<b>Withstand pressure</b>	500 kPa		2 MPa	4 MPa	
<b>Power supply</b>	<b>Power supply voltage</b>	When used as a switch output device (When not used as an IO-Link device) 12 to 24 VDC ±10% with 10% voltage ripple (p-p) or less When used as an IO-Link device 18 to 30 VDC, including ripple (p-p) 10%				
	<b>Current consumption</b>	35 mA or less				
	<b>Protection</b>	Polarity protection				
<b>Accuracy</b>	<b>Display accuracy</b>	±2% F.S. ±1 digit (Ambient temperature of 25 ±3°C)				
	<b>Repeatability</b>	±0.2% F.S. ±1 digit				
	<b>Temperature characteristics</b>	±3% F.S. (25°C standard)				
<b>Switch output (SIO mode)</b>	<b>Output type</b>	Select from NPN or PNP open collector output.				
	<b>Output mode</b>	Hysteresis mode, Window comparator mode, Error output, Output OFF				
	<b>Switch operation</b>	Normal output, Reversed output				
	<b>Max. load current</b>	80 mA				
	<b>Max. applied voltage (NPN only)</b>	28 V				
	<b>Internal voltage drop (Residual voltage)</b>	1.5 V or less (at load current of 80 mA)				
	<b>Delay time*1</b>	1.5 ms or less, variable from 0 to 60 s/0.01 s increments				
	<b>Hysteresis</b>	<b>Hysteresis mode</b>	Variable from 0*2			
		<b>Window comparator mode</b>				
	<b>Short circuit protection</b>	Yes				
<b>Display</b>	<b>Unit*3</b>	MPa, kPa, kgf/cm <sup>2</sup> , bar, psi, inHg, mmHg		MPa, kPa, kgf/cm <sup>2</sup> , bar, psi		
	<b>Display type</b>	LCD				
	<b>Number of screens</b>	3-screen display (Main screen, Sub screen x 2)				
	<b>Display color</b>	1) Main screen: Red/Green 2) Sub screen: Orange				
	<b>Number of display digits</b>	1) Main screen: 4 digits (7 segments) 2) Sub screen: 4 digits (Upper 1 digit 11 segments, 7 segments for other)				
	<b>Indicator light</b>	Lights up when switch output is turned ON (OUT1, OUT2: Orange)				
<b>Digital filter*4</b>		Variable from 0 to 30 s/0.01 s increments				
<b>Environmental resistance</b>	<b>Enclosure</b>	IP65				
	<b>Withstand voltage</b>	250 VAC for 1 minute between terminals and housing				
	<b>Insulation resistance</b>	2 MΩ or more (50 VDC measured via megohmmeter) between terminals and housing				
	<b>Operating temperature range</b>	Operating: -5 to 50°C, Stored: -10 to 60°C (No condensation)				
	<b>Operating humidity range</b>	Operating/Stored: 35 to 85% RH (No condensation)				
<b>Standards</b>		CE/UKCA marking				
<b>Length of lead wire with connector</b>		2 m				
<b>Communication (IO-Link mode)</b>	<b>IO-Link type</b>	Device				
	<b>IO-Link version</b>	V1.1				
	<b>Communication speed</b>	COM2 (38.4 kbps)				
	<b>Configuration file</b>	IODD file*5				
	<b>Minimum cycle time</b>	2.3 ms				
	<b>Process data length</b>	Input data: 2 bytes, Output data: 0 bytes				
	<b>On request data communication</b>	Yes				
	<b>Data storage function</b>	Yes				
	<b>Event function</b>	Yes				
	<b>Vendor ID</b>	131 (0 x 000083)				

\*1 Value without digital filter (at 0 ms)

\*2 If the applied pressure fluctuates around the set value, the hysteresis must be set to a value greater than the amount of fluctuation, or chattering will occur.

\*3 Setting is only possible for models with the units selection function. Only MPa or kPa is available for models without this function.

\*4 The response time indicates when the set value is 90% in relation to the step input.

\*5 The configuration file can be downloaded from the SMC website, <https://www.smcworld.com>

\* Products with tiny scratches, marks, or display color or brightness variations which do not affect the performance of the product are verified as conforming products.

## Piping Specifications and Weights

Model	02	N02	F02	C01	A2	B2	
<b>Port size</b>	R1/4	NPT1/4	G1/4	Rc1/8	URJ1/4	TSJ1/4	
<b>Materials of parts in contact with fluid</b>	Pressure sensor: Stainless steel 630, Fitting: Stainless steel 304, Grease-free						
<b>Weight</b>	<b>Body (Rear ported)</b>	51 g	51 g	48 g	47 g	54 g	46 g
	<b>Body (Bottom ported)</b>	77 g	78 g	74 g	65 g	81 g	72 g
	<b>Lead wire with connector</b>	+39 g					

## Cable Specifications

<b>Conductor cross section</b>	0.15 mm <sup>2</sup> (AWG26)	
<b>Insulator</b>	<b>O.D.</b>	1.0 mm
	<b>Color</b>	Brown, Blue, Black, White, Gray (5-core)
<b>Sheath</b>	<b>Finished O.D.</b>	ø3.5

ZSE20(F)  
ISE20

ZSE20A(F)  
ISE20A

ZSE20B(F)  
ISE20B

ZSE20B(F)-L  
ISE20B-L

ZSE20C(F)  
ISE20C(H)

ZSE20C(F)-L  
ISE20C(H)-L

Function  
Details

Made to  
Order

# ZSE20C(F)/ISE20C(H) Series

## Set Pressure Range and Rated Pressure Range

### Set the pressure within the rated pressure range.

The set pressure range is the range of pressure within which setting is possible. The rated pressure range is the range of pressure that satisfies the specifications (accuracy, linearity, etc.) of the switch. Although it is possible to set a value outside the rated pressure range, the specifications cannot be guaranteed even if the value stays within the set pressure range.

Switch		Pressure range					
		-100 kPa	0	100 kPa	500 kPa	1 MPa	2 MPa
For vacuum pressure	ZSE20C ZSE20C-L	-101 kPa	0				
		-105 kPa	10 kPa				
For compound pressure	ZSE20CF ZSE20CF-L	-100 kPa		100 kPa			
		-105 kPa		105 kPa			
For positive pressure	ISE20C ISE20C-L	-100 kPa				1 MPa	
		-105 kPa (-0.105 MPa)				1.05 MPa	
	ISE20CH ISE20CH-L	-100 kPa					2 MPa
		-105 kPa (-0.105 MPa)					2.1 MPa

Rated pressure range of the switch
  Set pressure range of the switch

## Analog Output

### Voltage output

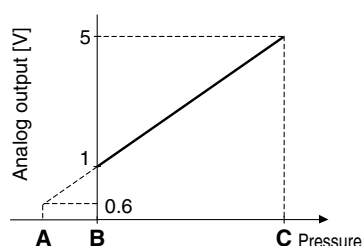

### Current output

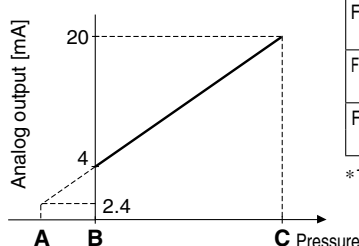

Range	Rated pressure range	A	B	C
For vacuum pressure	0.0 to -101.0 kPa	10.1 kPa	0	-101.0 kPa
For compound pressure	-100.0 to 100.0 kPa	—	-100.0 kPa	100.0 kPa
For positive pressure	-0.100 to 1.000 MPa	-0.100 MPa	0	1.000 MPa
	-0.100 to 2.00 MPa	-0.100 MPa*1	0	2.00 MPa

\*1 Analog output is 0.8 [V] or 3.2 [mA] at the pressure A.

\* Excludes the 20C(F/H)-L

## IO-Link: Process Data

### Relationship between the process data and pressure value

#### ZSE20C-L (For vacuum pressure)

Process data

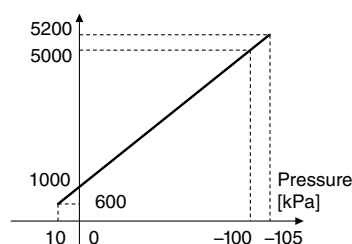

#### ZSE20CF-L (For compound pressure)

Process data

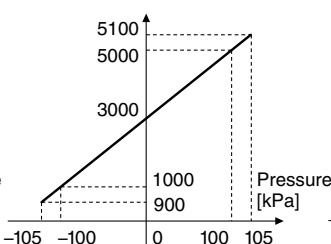

#### ISE20C-L (For positive pressure)

Process data

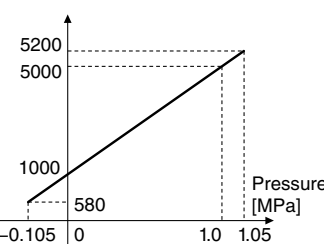

#### ISE20CH-L (For positive pressure)

Process data

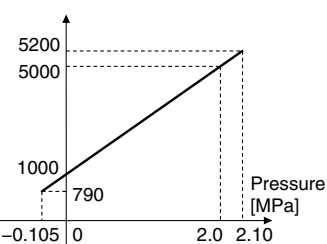

## Functions

Sub screen setting function	The display of the sub screen can be selected.
Auto-preset function	This function calculates a rough set value automatically based on the on-going operation.
Display value fine adjustment function	Evens out deviations in the displayed value
Peak value indication function	Can retain the maximum pressure value displayed during measurement
Bottom value indication function	Can retain the minimum pressure value displayed during measurement
Key-lock function (Selectable security code)	The keyboard can be locked to prevent the accidental operation of the operation switch.
Zero-clear function	The pressure display can be set to zero when the pressure is open to the atmosphere.
Error indication function	This function displays the error location and content when a problem or error has occurred.
Anti-chattering function	Prevents possible malfunctions due to sudden fluctuations in the primary pressure by adjusting the delay time
Units selection function	Can convert the display value
Power saving mode	Reduces power consumption
Display resolution switch function	Converts the display resolution from the normal value of 1/1000 to 1/100 Can reduce flickering of the monitor
kPa ↔ MPa switch function	Converts the unit between kPa and MPa
Copy function*1	The settings of the copy source can be copied to the copy destination.
Auto-shift function*1	Measures the pressure at the time of external input and uses it as a reference to correct the set value of the switch

\*1 Not available for the 20C(F/H)-L



**Internal Circuits and Wiring Examples**

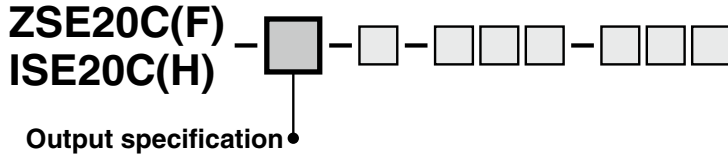

**-X**  
**NPN (2 outputs) + Copy function**

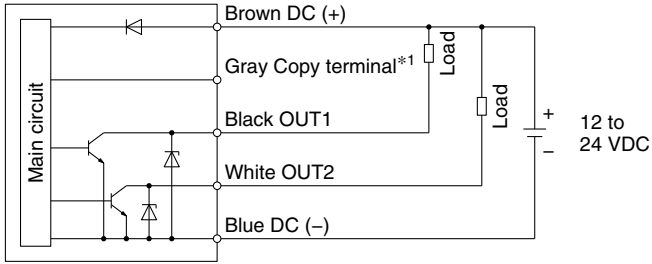

**-Y**  
**PNP (2 outputs) + Copy function**

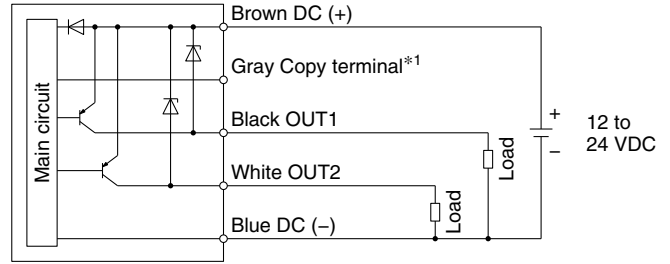

**-R: NPN (2 outputs) + Analog voltage output**  
**-S: NPN (2 outputs) + Analog current output**

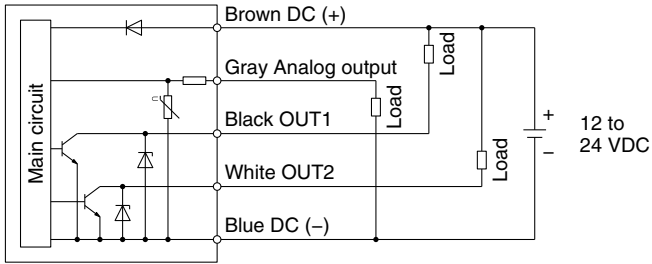

**-T: PNP (2 outputs) + Analog voltage output**  
**-V: PNP (2 outputs) + Analog current output**

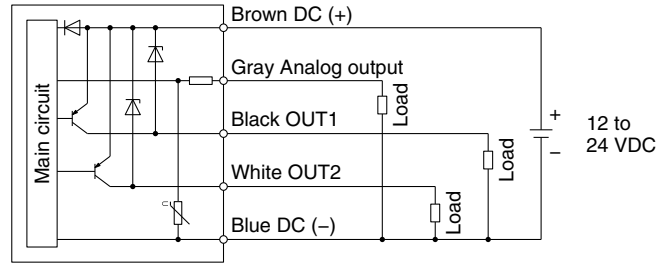

**-R: NPN (2 outputs) + Auto-shift input**  
**-S: NPN (2 outputs) + Auto-shift input**

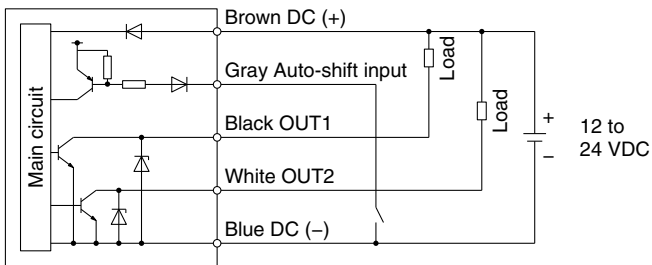

**-T: PNP (2 outputs) + Auto-shift input**  
**-V: PNP (2 outputs) + Auto-shift input**

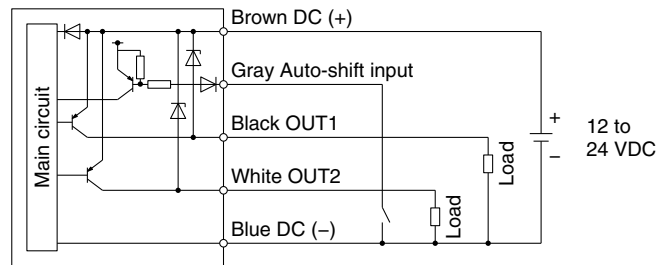

**-R: NPN (2 outputs) + Copy function**  
**-S: NPN (2 outputs) + Copy function**

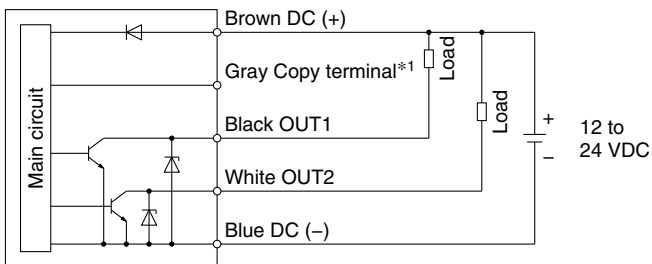

**-T: PNP (2 outputs) + Copy function**  
**-V: PNP (2 outputs) + Copy function**

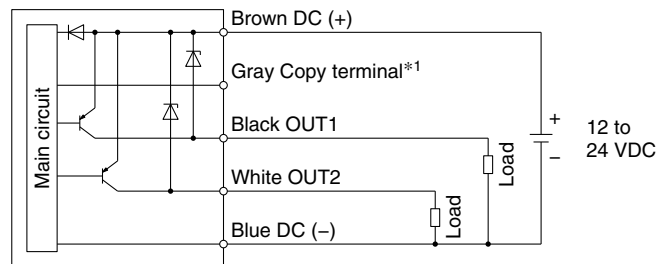

\*1 Refer to page 41.

# ZSE20C(F)/ISE20C(H) Series

## Internal Circuits and Wiring Examples

ZSE20C(F)  
ISE20C(H) - **L** - □ - □ □ - □ □ □

Output specification

**-L:** (IO-Link/Switch: 1 output)

When used as a switch output device (When not used as an IO-Link device = When in SIO mode)

**NPN open collector 1 output setting**

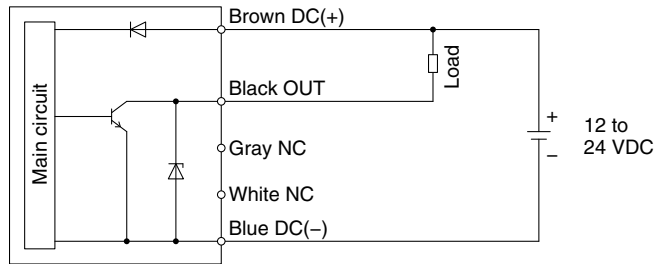

**PNP open collector 1 output setting**

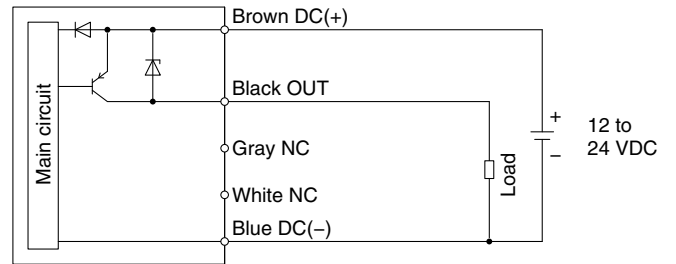

When used as an IO-Link device

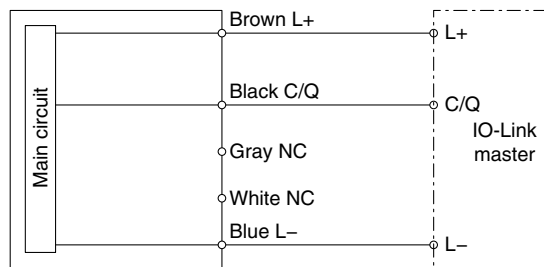

# 3-Screen Display High-Precision Digital Pressure Switch for General Fluids **ZSE20C(F)/ISE20C(H) Series**

## Dimensions

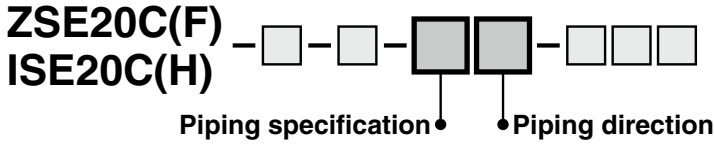

**02**

R1/4

**N02**

NPT1/4

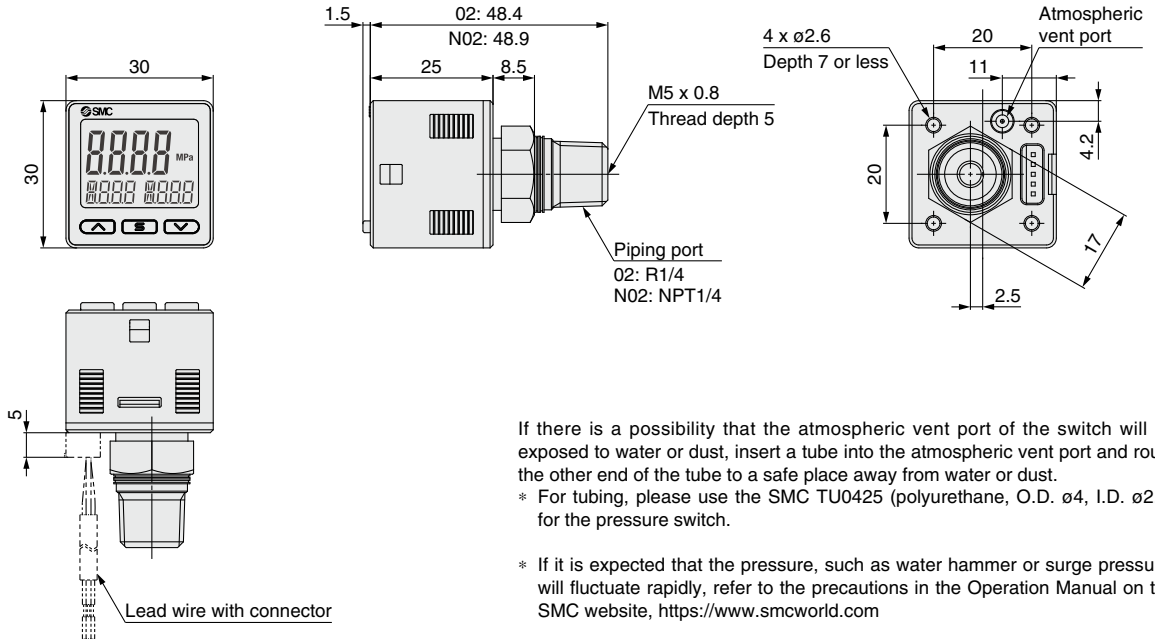

If there is a possibility that the atmospheric vent port of the switch will be exposed to water or dust, insert a tube into the atmospheric vent port and route the other end of the tube to a safe place away from water or dust.

\* For tubing, please use the SMC TU0425 (polyurethane, O.D. ø4, I.D. ø2.5) for the pressure switch.

\* If it is expected that the pressure, such as water hammer or surge pressure, will fluctuate rapidly, refer to the precautions in the Operation Manual on the SMC website, <https://www.smcworld.com>

**F02**

G1/4

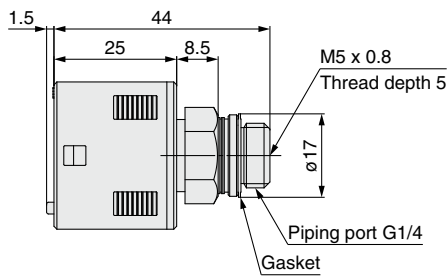

**C01**

Rc1/8

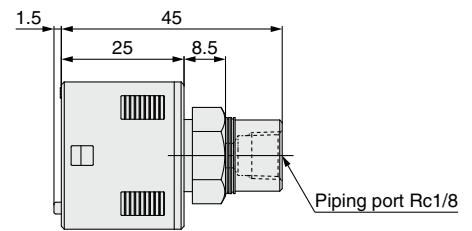

**A2**

URJ1/4

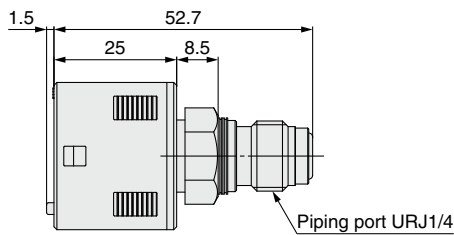

**B2**

TSJ1/4

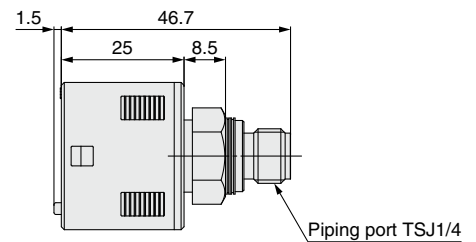

Adapter with restrictor  
**ZS-31-X□□□**  
Material: Stainless steel 304

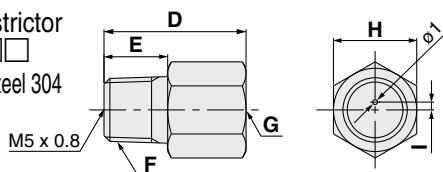

Orifice  
**ZS-48-A**  
Material: Stainless steel 303

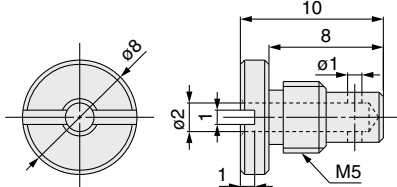

Part no.	D	E	F	G	H	I
<b>ZS-31-X188</b>	20	9	R1/8	Rc1/8	14	1.5
<b>ZS-31-X175</b>	29	13	R1/4	Rc1/4	17	1.6
<b>ZS-31-X186</b>	29	13	NPT1/4	NPT1/4	17	1.6

[mm]

\* If it is expected that the pressure, such as water hammer or surge pressure, will fluctuate rapidly, refer to the precautions in the Operation Manual on the SMC website, <https://www.smcworld.com>

# ZSE20C(F)/ISE20C(H) Series

## Dimensions

ZSE20C(F)  
ISE20C(H)

Piping specification      Piping direction

**O2L**

R1/4

**N02L**

NPT1/4

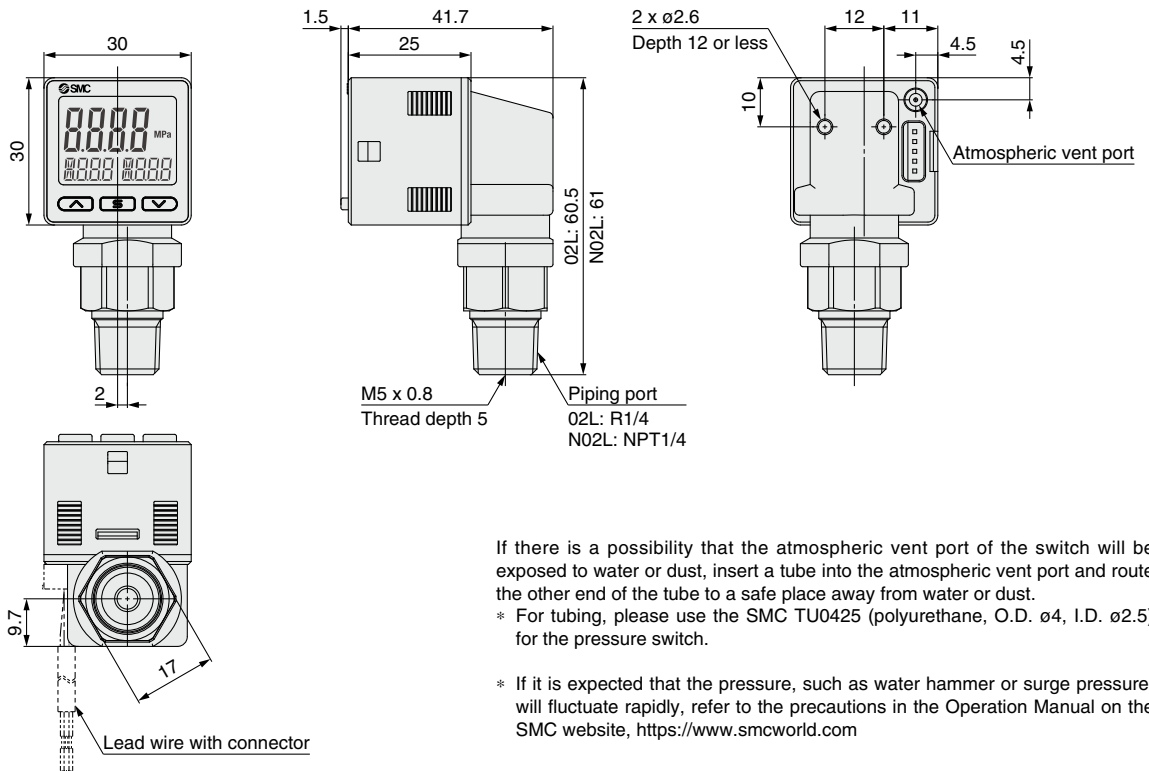

If there is a possibility that the atmospheric vent port of the switch will be exposed to water or dust, insert a tube into the atmospheric vent port and route the other end of the tube to a safe place away from water or dust.

\* For tubing, please use the SMC TU0425 (polyurethane, O.D. ø4, I.D. ø2.5) for the pressure switch.

\* If it is expected that the pressure, such as water hammer or surge pressure, will fluctuate rapidly, refer to the precautions in the Operation Manual on the SMC website, <https://www.smcworld.com>

**F02L**

G1/4

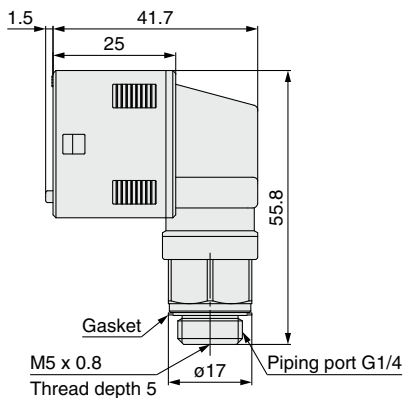

**C01L**

Rc1/8

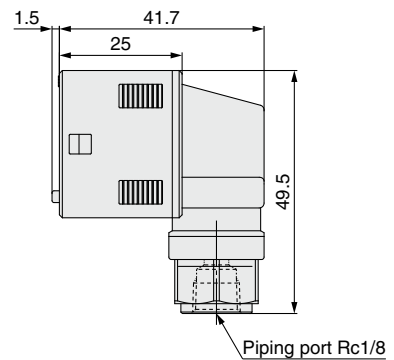

**A2L**

URJ1/4

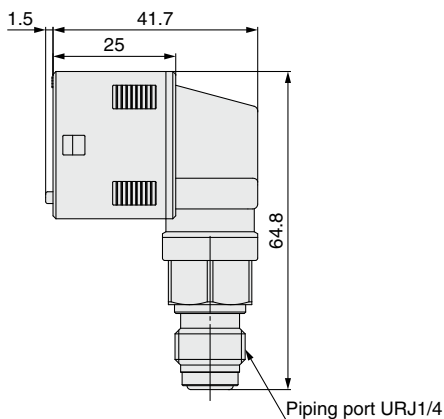

**B2L**

TSJ1/4

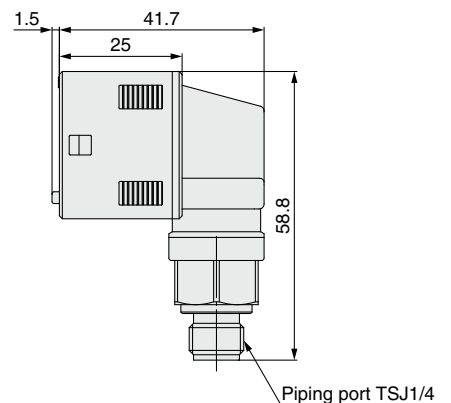

**Dimensions**

With bracket

**ZSE20C(F)**  
**ISE20C(H)**



• Option 2

**A1**

**Bracket A (Rear ported)**  
(Part no.: ZS-46-A1)

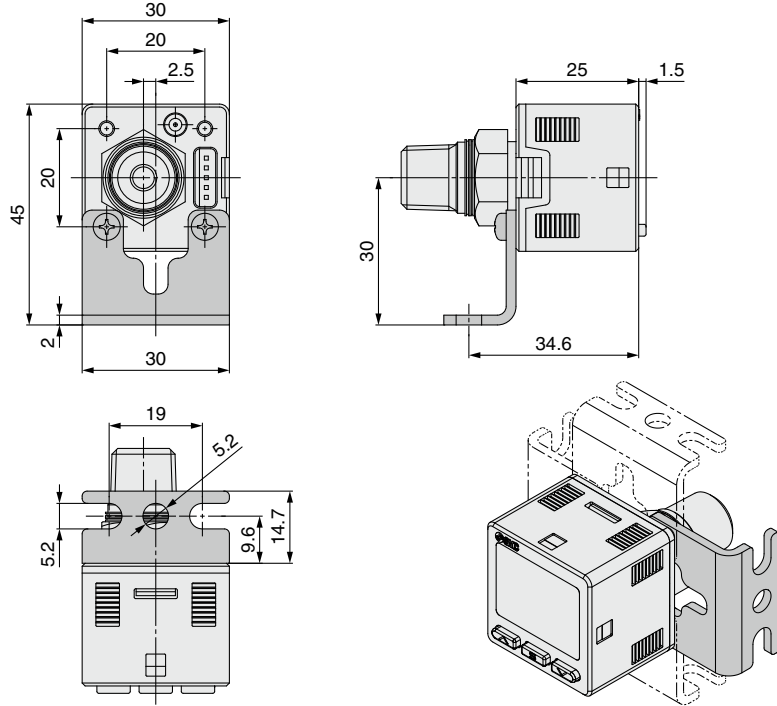

**A3**

**Bracket C (Bottom ported)**  
(Part no.: ZS-46-E)

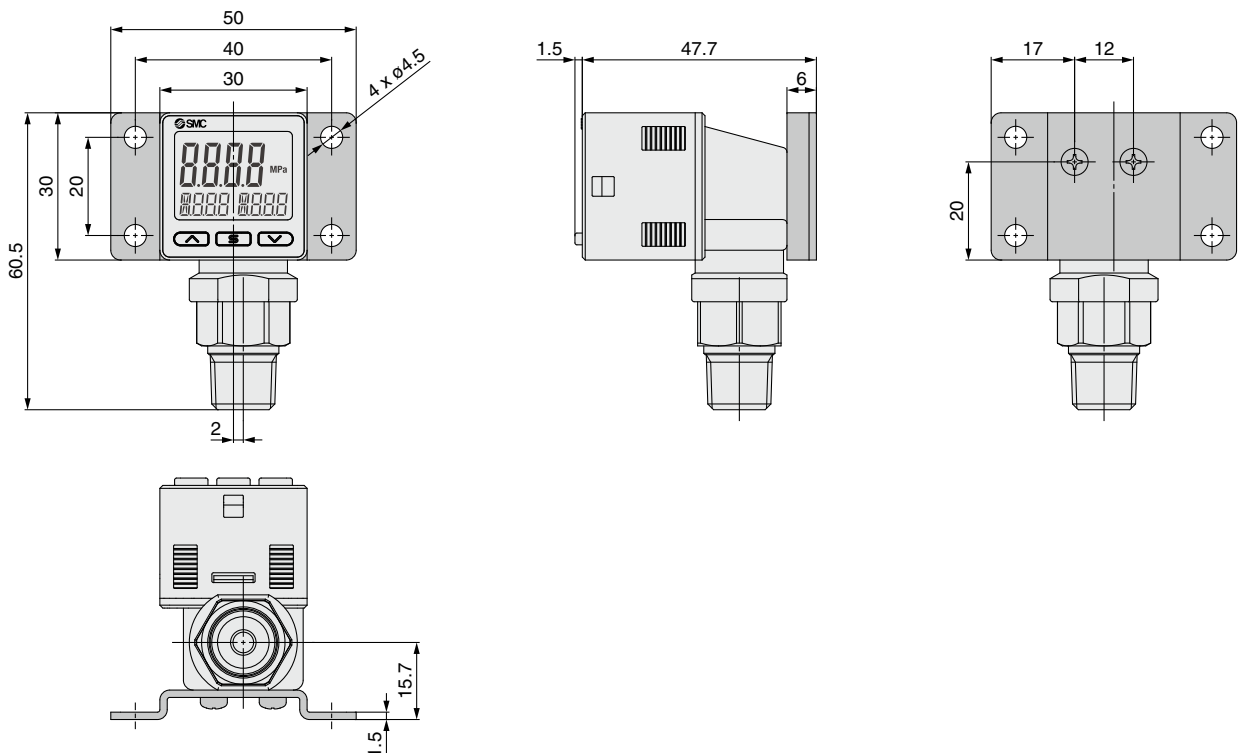

ZSE20(F)  
ISE20

ZSE20A(F)  
ISE20A

ZSE20B(F)  
ISE20B

ZSE20B(F)-L  
ISE20B-L

ZSE20C(F)  
ISE20C(H)

ZSE20C(F)-L  
ISE20C(H)-L

Function  
Details

Made to  
Order

# ZSE20C(F)/ISE20C(H) Series

## Dimensions

### Panel mount adapter

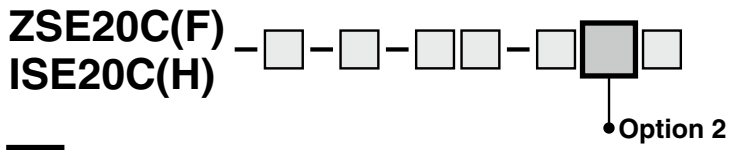

**B**

### Panel mount adapter (Rear ported) (Part no.: ZS-46-B)

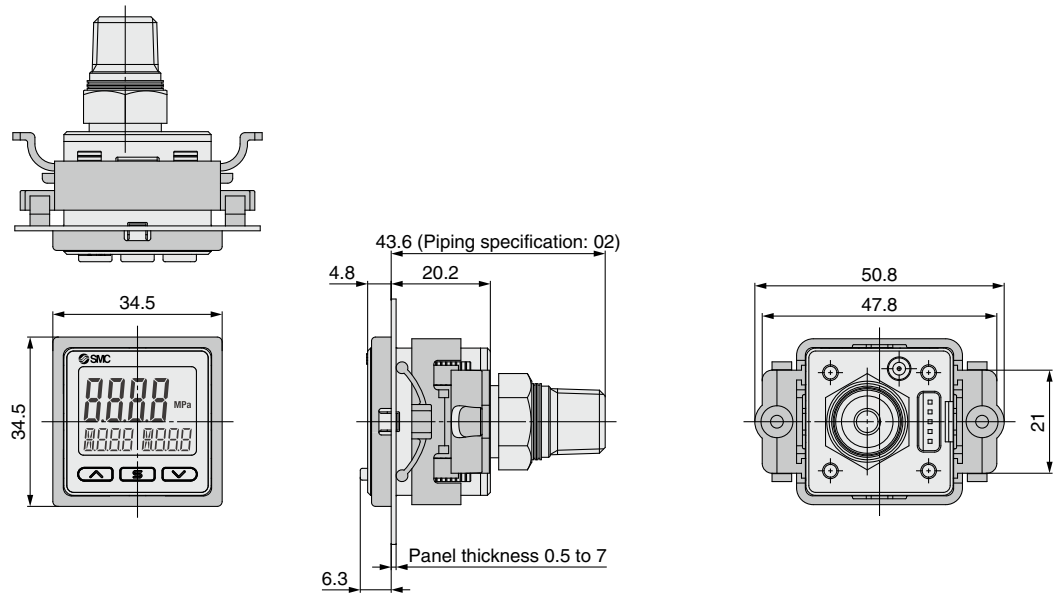

**E**

### Panel mount adapter (Bottom ported) (Part no.: ZS-35-B)

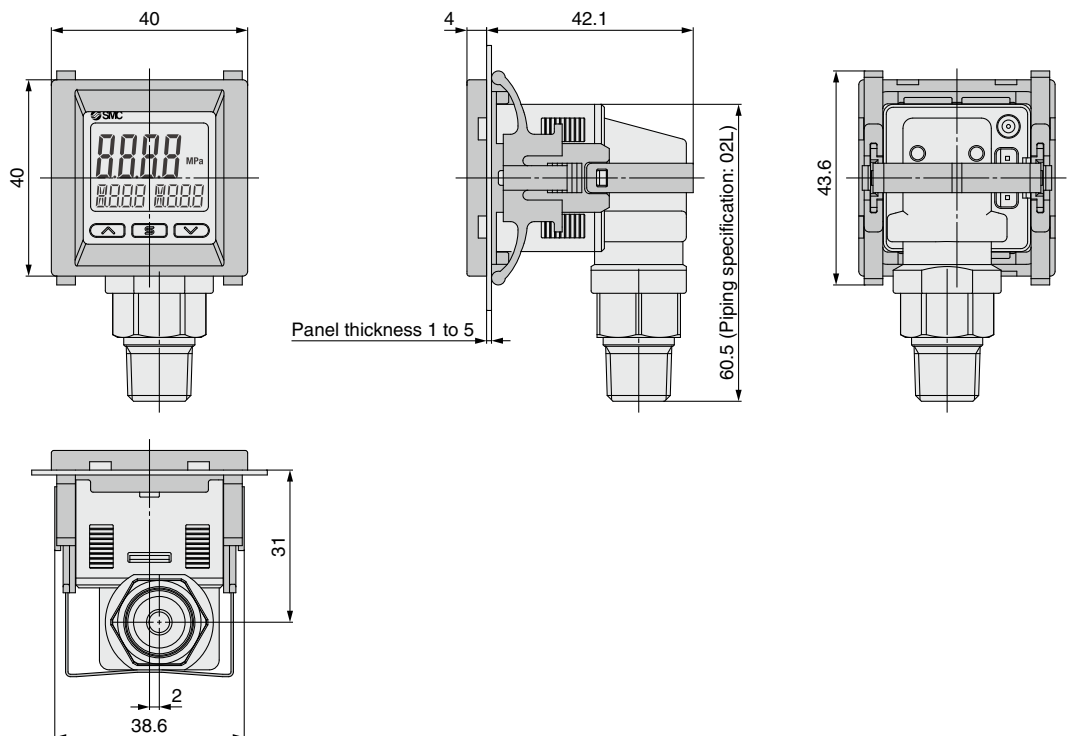

**Dimensions**

**Panel mount adapter**

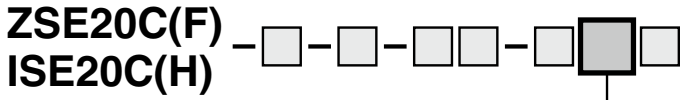

• Option 2

**D**

**Panel mount adapter + Front protection cover (Rear ported)**  
(Part no.: ZS-46-D)

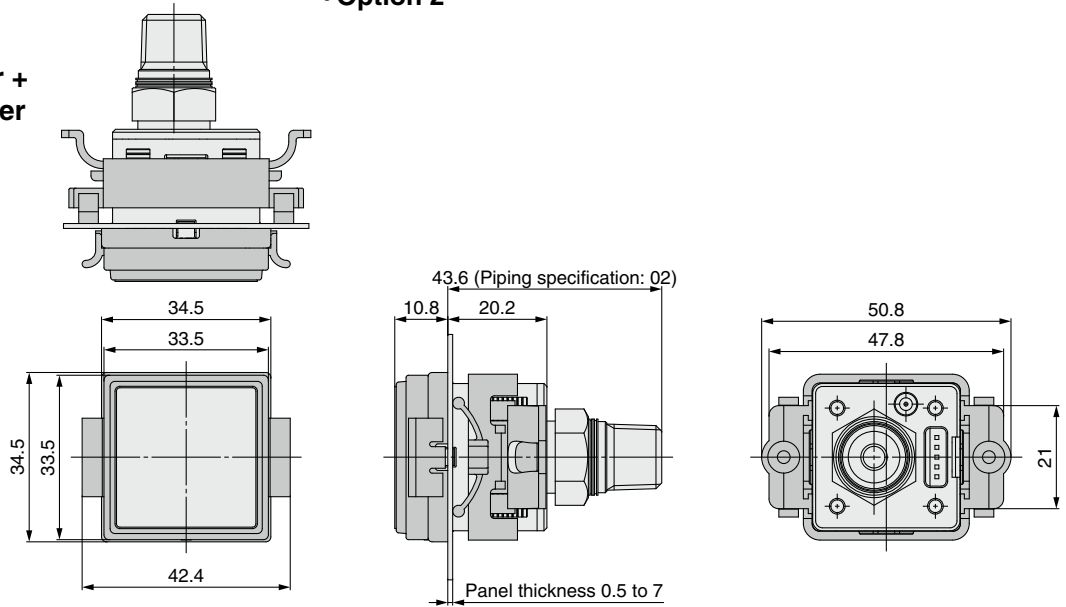

**F**

**Panel mount adapter + Front protection cover (Bottom ported)**  
(Part no.: ZS-35-E)

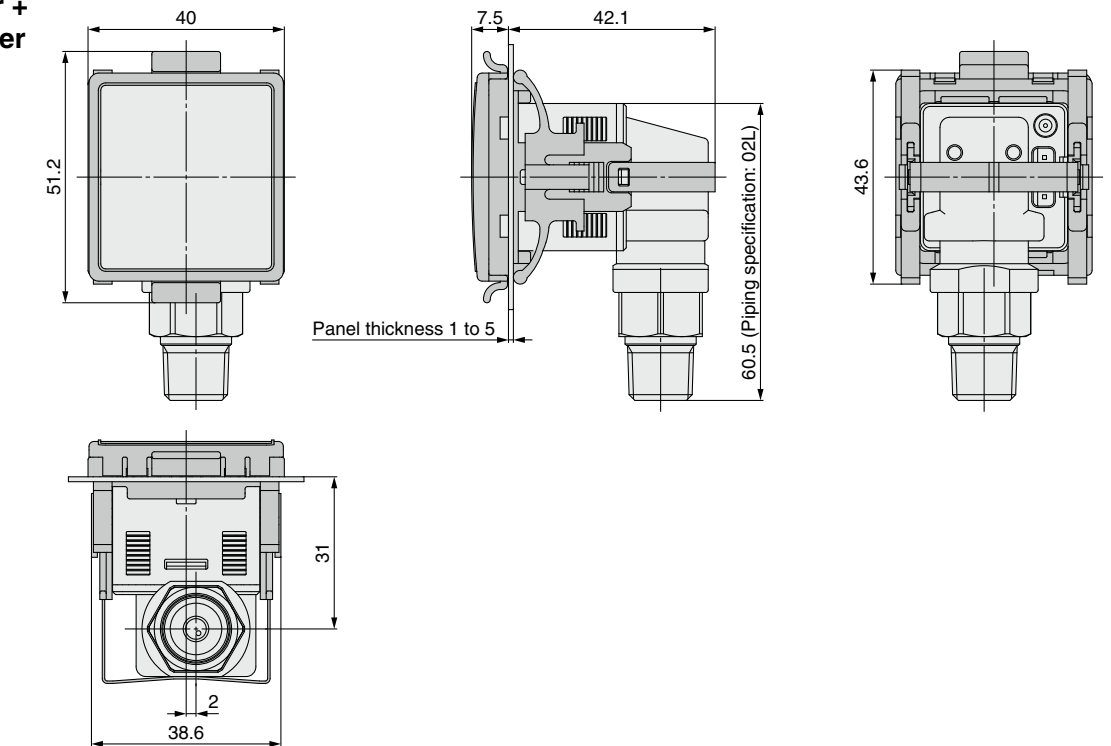

**Lead wire with connector: For ZSE20C(F)/ISE20C(H)**  
(Part no.: ZS-46-5F)

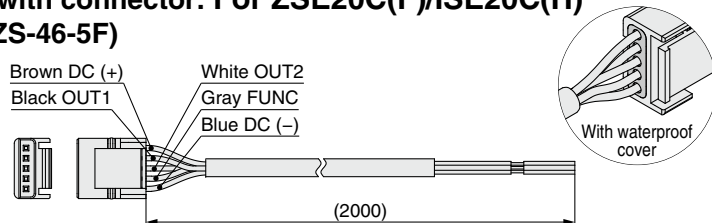

\* For the lead wire with M12 connector, refer to page 43.

ZSE20(F)  
ISE20

ZSE20A(F)  
ISE20A

ZSE20B(F)  
ISE20B

ZSE20B(F)-L  
ISE20B-L

ZSE20C(F)  
ISE20C(H)

ZSE20C(F)-L  
ISE20C(H)-L

Function  
Details

Made to  
Order

# ZSE20C(F)/ISE20C(H) Series

## Dimensions

### Panel fitting dimensions (Rear ported)

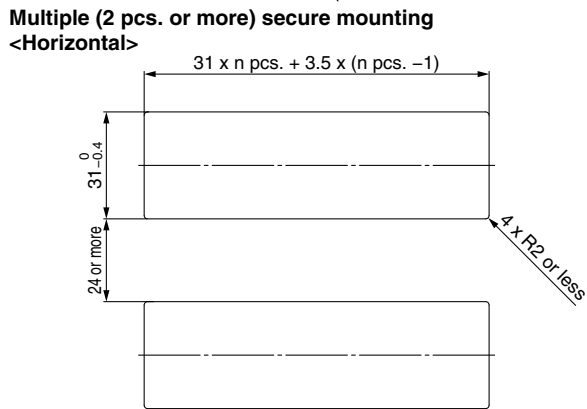
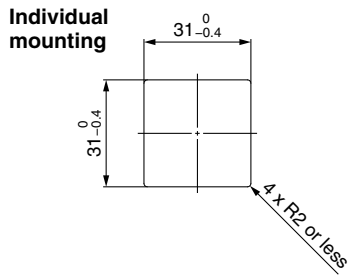

**Panel mount example  
<Horizontal>**

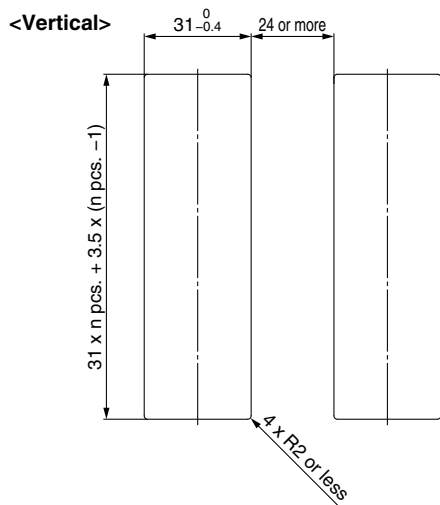
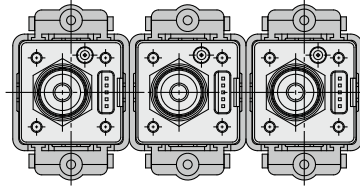

**Panel mount example  
<Vertical>**

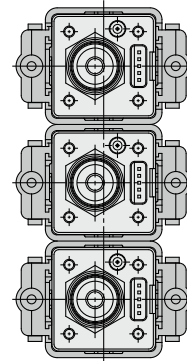

### Panel fitting dimensions (Bottom ported)

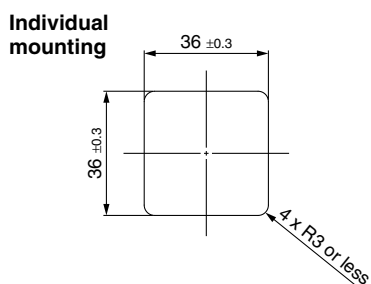

**Multiple (2 pcs. or more) secure mounting  
<Horizontal>**

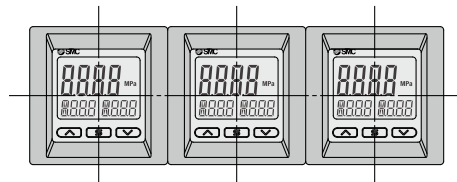
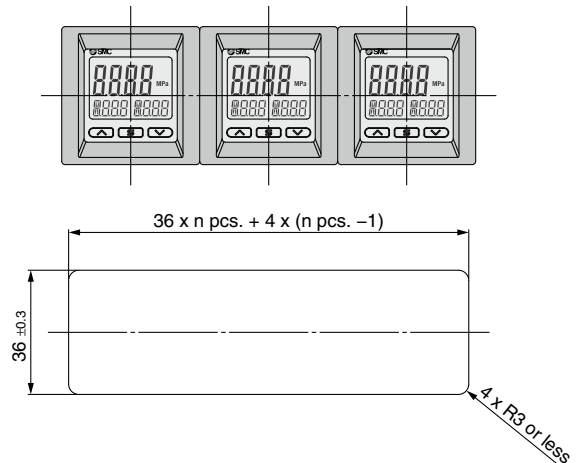



# ZSE20□(F)/ISE20□ Series Function Details

Display examples of the main and sub (set value) screens of each mode. (For ISE20□ (for Positive pressure))

## Hysteresis mode Normal output

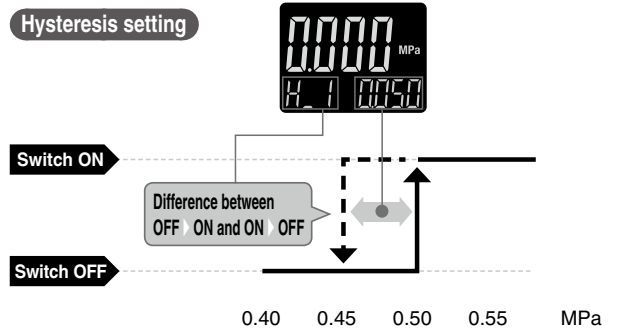
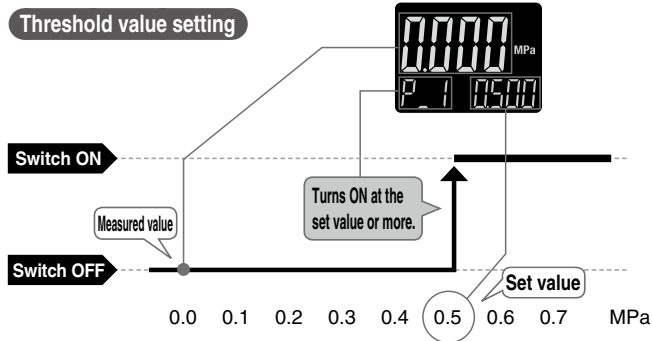

## Hysteresis mode Reversed output

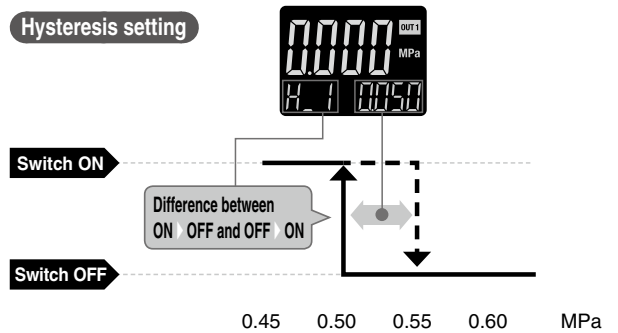
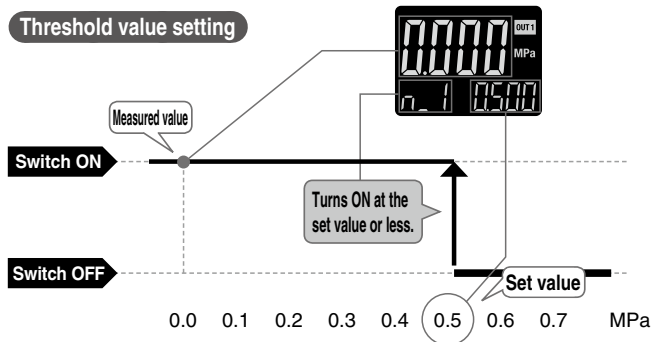

## Window comparator mode Normal output

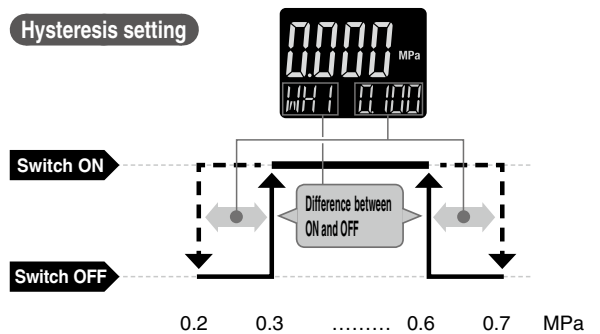
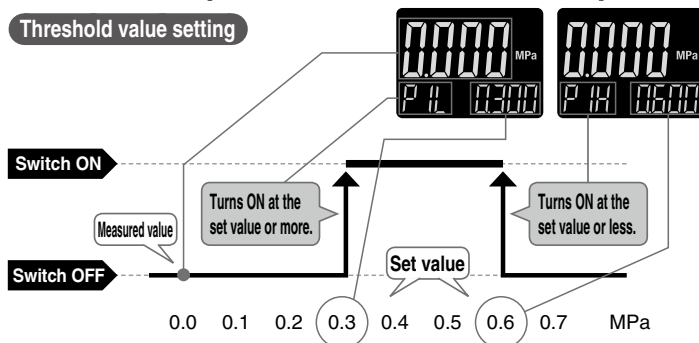

## Window comparator mode Reversed output

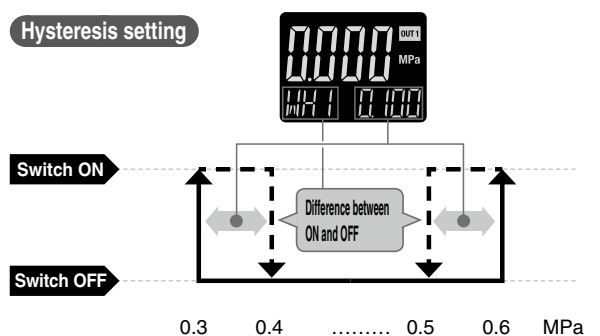
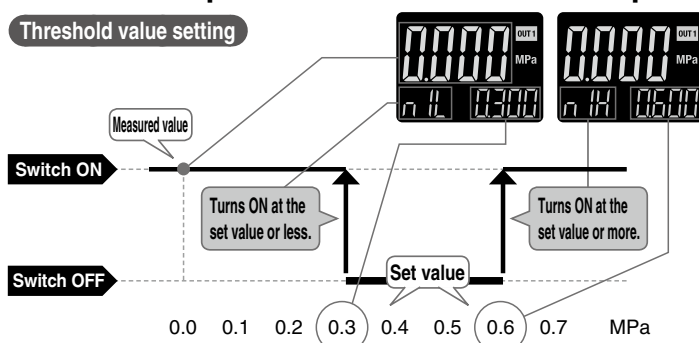

ZSE20(F)  
ISE20

ZSE20A(F)  
ISE20A

ZSE20B(F)  
ISE20B

ZSE20B(F)-L  
ISE20B-L

ZSE20C(F)  
ISE20C(H)

ZSE20C(F)-L  
ISE20C(H)-L

Function  
Details

Made to  
Order

The F□ in ( ) shows the function code number. For details about operation procedures and function codes, refer to the “Operation Manual” on the SMC website.



## Function Details

### A Auto-preset function (F4)

This function, when selected in the initial setting, calculates and stores the set value from the measured pressure. For example, if this function is used for suction verification, the optimum set value is determined automatically by performing suction and release of several workpieces.

#### Suction Verification

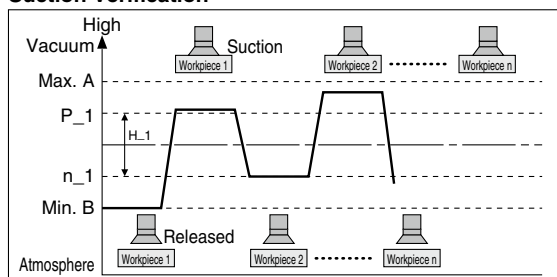

\* When using with IO-Link, the set values cannot be changed by communication.

#### Formula for Obtaining the Set Value

P_1 or n_1	H_1
$P_1 = A - (A - B) / 4$	$H_1 =  (A - B) / 2 $
$n_1 = B + (A - B) / 4$	

### B Display value fine adjustment function (F6)

Fine adjustment of the indicated value of the pressure sensor can be made within the range of  $\pm 5\%$  of the read value. (This eliminates wide variations of the indicated value.)

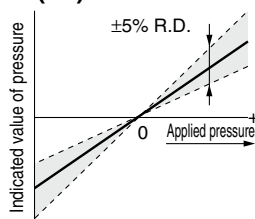

— Indicated value at the time of shipment  
 [Shaded Area] Adjustable range of display value fine adjustment function

\* When the display value fine adjustment function is used, the set pressure value may change  $\pm 1$  digit.

### C Peak/Bottom value display

This function constantly detects and updates the maximum (minimum) pressure when the power is supplied, and allows to hold the maximum (minimum) pressure value.

The held value is maintained even if the power supply is cut.

When the and buttons are simultaneously pressed for 1 second or longer, while “holding”, the held value will be reset.

### D Key-lock function

This function prevents operation errors such as accidentally changing setting values.

### E Zero-clear function

This function clears and resets the zero value on the display of measured pressure.

The indicated value can be adjusted within  $\pm 7\%$  F.S. of the pressure at the time of shipment from the factory. (ZSE20□F (for compound pressure):  $\pm 3.5\%$  F.S.)

### F Error display function

When an error or abnormality arises, the location and contents are displayed.

Error name	Error code	Description	Action
Over current error		A load current of 80 mA or more is applied to the switch output.	Eliminate the cause of the over current by turning off the power supply and then turn it on again.
Residual pressure error		During zero-clear operation, pressure over $\pm 7\%$ F.S. ( $\pm 3.5\%$ F.S. for compound pressure) is present. Note that the mode is returned to measurement mode automatically 1 second later. The zero-clear range varies by $\pm 1\%$ F.S. due to variation between individual products.	Perform zero-clear operation again after restoring the applied pressure to an atmospheric pressure condition.
Applied pressure error		Supply pressure exceeds the maximum set pressure.	Reset applied pressure to a level within the set pressure range
		Supply pressure is below the minimum set pressure.	
System error		An internal data error has occurred.	Turn the power off and then on again. If the error cannot be solved, please contact SMC for investigation.
Copy error		The copy function does not operate properly.	After clearing the error by pressing the  and  buttons simultaneously for a minimum of 1 second, check the wiring and the model, and then attempt to copy again.
IO-Link master version error		The IO-Link version does not match that of the master.	Ensure that the master IO-Link version matches the device version.

If the error cannot be solved after the instructions above are performed, or errors other than those above are displayed, please contact SMC for investigation.



The F□ in ( ) shows the function code number. For details about operation procedures and function codes, refer to the “Operation Manual” on the SMC website.

## Function Details

### G Anti-chattering function (Simple setting mode or F1, F2)

A large bore cylinder or ejector consumes a large volume of air during operation and may experience a temporary drop in the supply pressure. This function prevents detection of such temporary drops in the supply pressure as an error by changing the delay time setting.

Available delay time settings
1.5 ms or less, 20 ms, 100 ms, 500 ms, 1000 ms, 2000 ms, 5000 ms

#### <Principle>

This function averages pressure values measured during the response time set by the user and then compares the average pressure value with the pressure set point value to output the result on the switch.

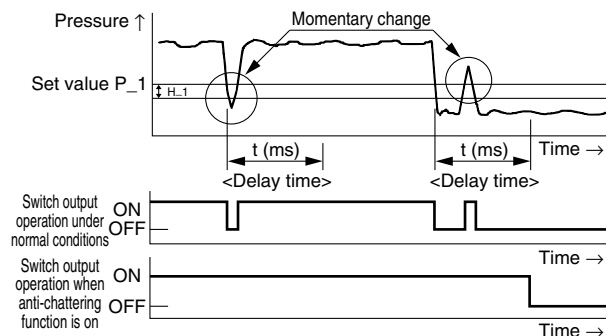

### H Units selection function (F0)

Display units can be switched with this function.

Display unit	MPa	kPa	kGF	bAr	PSi	inCH	mmHG
Smallest settable increment	MPa*1	kPa	kgf/cm <sup>2</sup>	bar	psi	inHg	mmHg
ZSE20□ (Vacuum pressure)	0.001	0.1	0.001	0.001	0.01	0.1	1
ZSE20□F (Compound pressure)	0.001	0.1	0.001	0.001	0.02	0.1	1
ISE20□ (Positive pressure)	0.001	1	0.01	0.01	0.1		
ISE20□H (Positive pressure)	0.001	1	0.01	0.01	0.2		

\*1 The ZSE20□ (vacuum pressure) and ZSE20□F (compound pressure) will have different setting and display resolution when the unit is set to MPa.

### I Selection of power saving mode (F80)

The power saving mode can be selected.

With this function, if no buttons are pressed for 30 s, it shifts to power saving mode.

At the time of shipment from the factory, the product is set to the normal mode (the power saving mode is turned off).

(During power saving mode, [ECo] will flash in the sub screen and the operation light will be ON (only when the switch is ON).)

### J Setting of security code (F81)

The user can select whether a security code must be entered to release the key lock.

At the time of shipment from the factory, it is set such that a security code is not required.

ZSE20(F)  
ISE20

ZSE20A(F)  
ISE20A

ZSE20B(F)  
ISE20B

ZSE20B(F)-L  
ISE20B-L

ZSE20C(F)  
ISE20C(H)

ZSE20C(F)-L  
ISE20C(H)-L

Function  
Details

Made to  
Order

# ZSE20□(F)/ISE20□ Series

The F□ in ( ) shows the function code number. For details about operation procedures and function codes, refer to the “Operation Manual” on the SMC website.



## Function Details

### K Copy function (F97) (Z/ISE20A, 20B, 20C series only)

The set values of the sensor can be copied.  
This can reduce setting labor and minimize the risk of setting mistakes.  
**The set value can be copied to up to 10 switches simultaneously.**  
(Maximum transmission distance: 4 m)

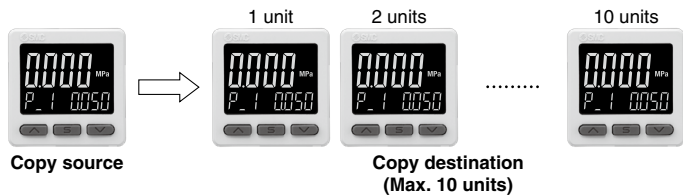

\* This function is not provided with the IO-Link compatible type.

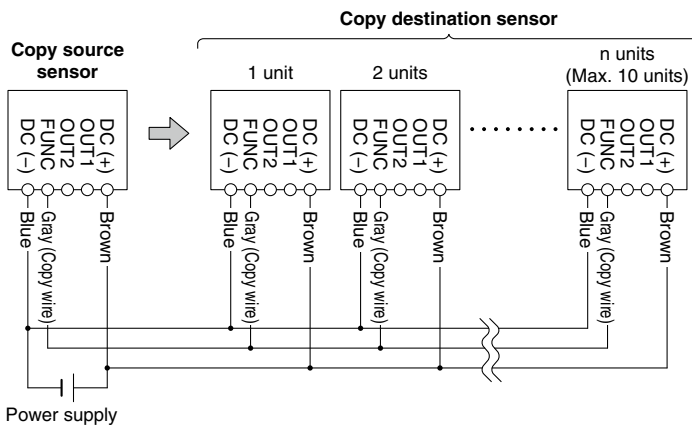

- 1) Wire as shown in the figure on the left.
- 2) All sensors are set to copy destination when first purchased. (Default condition is the sensor to be copied to.)
- 3) Press the **S** button on the source sensor to start copying.

### L Auto-shift function (F5) (Z/ISE20A, 20B, 20C series only)

When there are large fluctuations in the supply pressure, the switch may fail to operate correctly. The auto-shift function compensates for such supply pressure fluctuations. It measures the pressure at the time of auto-shift signal input and uses it as the reference pressure to correct the set value on the switch.

#### Set value correction by auto-shift function

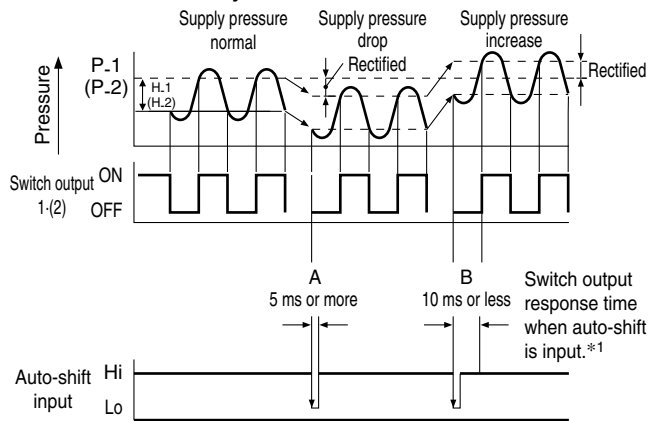

\*1 When delay time is 1.5 ms or less

When the auto-shift function is selected, “RS in 000” will be displayed on the sub screen for about 1 second, and the pressure value at that point will be saved as reference value “C\_5.” Based on the saved reference value, output on-off points controlled by set values\*2 such as “P\_1,” “H\_1,” “P\_2,” and “H\_2” will also be rectified.

\*2 When an output is reversed, output on-off points displayed at “n\_1,” “H\_1,” “n\_2,” and “H\_2” will be rectified.

The above is an example in hysteresis mode. On-off points are similarly rectified in window comparator mode. Outputs that enable the auto-shift function can be changed via the settings.

\* This function is not provided with the IO-Link compatible type.

#### Settable Range for Auto-Shift Input

	Set pressure range	Settable range
Compound pressure	-105.0 to 105.0 kPa	-210 to 210 kPa
Vacuum pressure	10.0 to -105.0 kPa	115.0 to -115.0 kPa
Positive pressure	-0.105 to 1.050 MPa	-1.155 to 1.155 MPa
Positive pressure*3	-0.105 to 2.100 MPa	-2.20 to 2.205 MPa

\*3 Z/ISE20C series only

#### Auto-shift zero

The basic function of auto-shift zero is the same as that of auto-shift. However, it corrects values on the display based on a pressure value of “0,” which is set as the reference value when auto-shift function is selected.

# ZSE20□(F)/ISE20□ Series Made to Order



Please contact SMC for detailed dimensions, specifications, and delivery times.

## 1 Parts in Contact with Fluid: Stainless Steel 316L

20C

This pressure switch has better corrosion resistance because it uses stainless steel 316L for the parts in contact with fluid (pressure sensor and fitting).

### How to Order

ZSE20C(F)/ISE20C - □ - □ - □ - □ - □ - □ - X500

Enter the standard product number. (p. 25)

- \* Not applicable to the rated pressure -0.1 to 2 MPa specifications (ISE20CH)
- \* A restrictor (equivalent to -X510) is installed inside the fitting. (Piping specifications A2(L) and B2(L) are excluded.)

### Specifications

Model	ZSE20C(F)	ISE20C
Withstand pressure	500 kPa	1.5 MPa
Applicable fluid	Liquids and gases that do not corrode stainless steel 316L	

Models other than those above have the same specifications as the standard product.

## 2 Restrictor-installed Fitting

20C

A restrictor is installed inside the fitting in order to reduce the effects of water collision with inertia force in the piping when adsorption is broken.

### How to Order

ZSE20C(F)/ISE20C(H) - □ - □ - □ - □ - □ - □ - X510

Enter the standard product number. (p. 25)

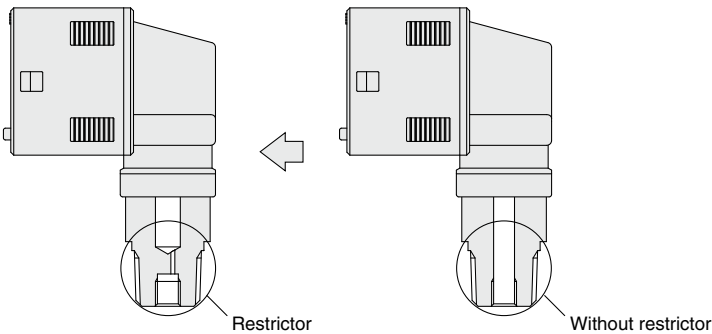

- \* Not applicable for piping specifications A2(L) and B2(L)
- \* There are cases in which this product will not effectively suppress the effects of water hammer. It is advised that other measures be taken in such cases.

## 3 Grease-free

20

20A

20B

This is a grease-free product.

- \* The grease-free specification does not intentionally apply grease to the parts in contact with fluid.

ZSE20(F)/ISE20 - □ - □ - □ - □ - □ - □ - X2  
 ZSE20A(F)/ISE20A - □ - □ - □ - □ - □ - □ - X2  
 ZSE20B(F)/ISE20B - □ - □ - □ - □ - □ - □ - X2

Enter the standard product number. (pp. 9, 11, 13)

- \* The ZSE20C(F) and the ISE20C(H) are grease-free specifications as standard.

ZSE20(F)  
ISE20

ZSE20A(F)  
ISE20A

ZSE20B(F)  
ISE20B

ZSE20B(F)-L  
ISE20B-L

ZSE20C(F)  
ISE20C(H)

ZSE20C(F)-L  
ISE20C(H)-L

Function  
Details

Made to  
Order

# ZSE20□(F)/ISE20□ Series

Please contact SMC for detailed dimensions, specifications, and delivery times.

## 4 3 m Lead Wire

20B

20C

This product features a lead wire which is 3 m in length.

ZSE20B(F)/ISE20B - □ - □ - □ - W □ □ - X500  
 ZSE20C(F)/ISE20C - □ - □ - □ - W □ □ - X502

Enter the standard product number. (pp. 13, 25) ●

## 5 M8 3-pin Pre-wired Connector (Lead wire length: 500 mm)

20B

ZSE20B(F)/ISE20B - X - □ - □ - W □ □ - X503

Output specification ●

● Enter the standard product number. (p. 13)

Symbol	Description
X	NPN 2 outputs (+ Copy function)
Y	PNP 2 outputs (+ Copy function)

\* As the product body is shipped with the copy function enabled, simply replace the standard product cable with this cable.

## 6 M12 4-pin Pre-wired Connector (Lead wire length: 100 mm)

20A

20B

20C

ZSE20A(F)/ISE20A - X - □ - □ - J □ □ - X505  
 ZSE20B(F)/ISE20B - X - □ - □ - W □ □ - X505  
 ZSE20C(F)/ISE20C - X - □ - □ - W □ □ - X505

Output specification ●

● Enter the standard product number. (pp. 11, 13, 25)

Symbol	Description
X	NPN 2 outputs (+ Copy function)
Y	PNP 2 outputs (+ Copy function)

\* As the product body is shipped with the copy function enabled, simply replace the standard product cable with this cable.

Optional lead wire part number: ZS-46-5FM12 (ZS-46-5LM12: Non-waterproof type)

Connector pin assignment

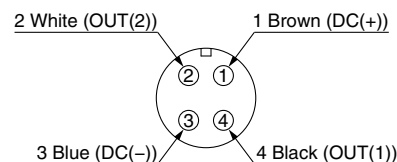
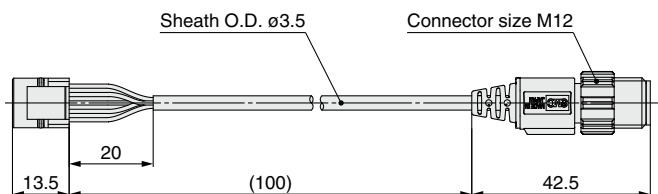

## 7 Lead Wire with Connector (Terminal cover)

20

20A

By using a waterproof lead wire for the connector portion, terminal exposure can be prevented.

\* The -X531 enclosure is IP40.

ZSE20(F)/ISE20 - □ - □ - □ - L □ □ - X531  
 ZSE20A(F)/ISE20A - □ - □ - □ - J □ □ - X531

Enter the standard product number. (pp. 9, 11) ●

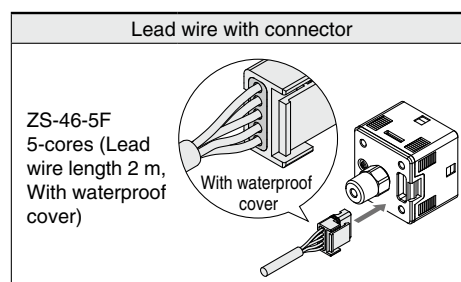

Please contact SMC for detailed dimensions, specifications, and delivery times.

**8 Conversion Cable for the Z/ISE30A Lead Wire with Connector**

20

20A

The conversion cable allows for connection between the existing Z/ISE30A lead wire with connector and the Z/ISE20.

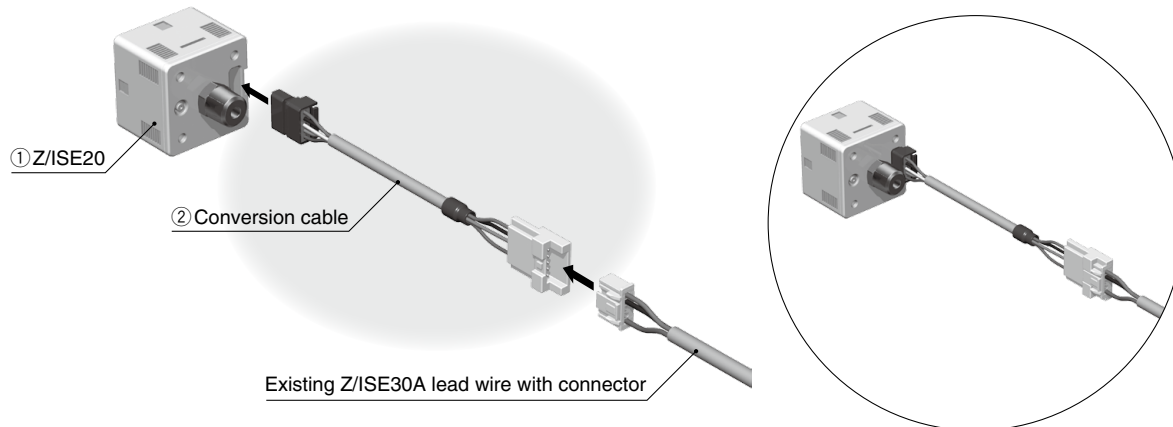

The output specification symbol may vary from that of the existing pressure switch.

**Z/ISE30A → Z/ISE20 + Conversion Cable Correspondence Table**

Existing digital pressure switch model	Output specification	① Pressure switch part no.	② Conversion cable part no.
Z/ISE30A-□-N-□□□□	NPN open collector 1 output	Z/ISE20-N-□-□-□□□□	ZS-46-5LA-X424*1
Z/ISE30A-□-P-□□□□	PNP open collector 1 output	Z/ISE20-P-□-□-□□□□	
Z/ISE30A-□-A-□□□□	NPN open collector 2 outputs	Z/ISE20A-X-□-□-□□□□	
Z/ISE30A-□-B-□□□□	PNP open collector 2 outputs	Z/ISE20A-Y-□-□-□□□□	
Z/ISE30A-□-C-□□□□	NPN open collector 1 output + Analog voltage output	Z/ISE20A-R-□-□-□□□□	ZS-46-5LB-X424*1
Z/ISE30A-D-□□□□	NPN open collector 1 output + Analog current output	Z/ISE20A-S-□-□-□□□□	
Z/ISE30A-E-□□□□	PNP open collector 1 output + Analog voltage output	Z/ISE20A-T-□-□-□□□□	
Z/ISE30A-F-□□□□	PNP open collector 1 output + Analog current output	Z/ISE20A-V-□-□-□□□□	

\*1 While this conversion cable allows for use of the existing wiring, output and functions other than that of the Z/ISE30A will be invalid (not wired).

**ZS-46-5LA-X424**

- Brown: 5
- Black: 4
- White: 3
- Gray: 2
- Blue: 1

- 5: Brown
- 4: Black
- 3: White
- 2: N.C.
- 1: Blue

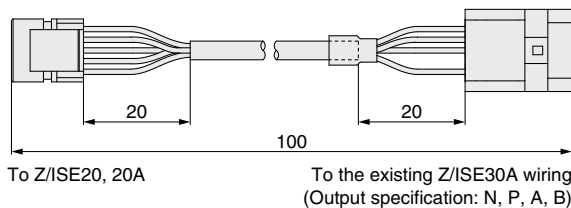

**ZS-46-5LB-X424**

- Brown: 5
- Black: 4
- White: 3
- Gray: 2
- Blue: 1

- 5: Brown
- 4: Black
- 3: Gray
- 2: N.C.
- 1: Blue

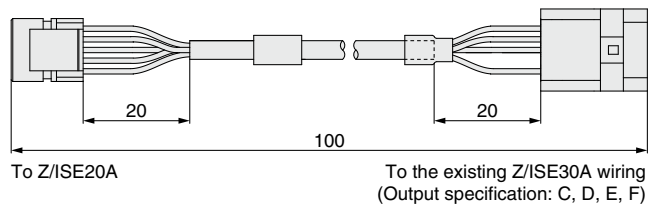

**9 With Spacer for Fitting Extension**

20

20A

20B

Allows for the easier insertion and removal of the lead wire with connector by extending the piping fitting

Part number for the spacer for extension: **ZS-46-M5A**

- ZSE20(F)/ISE20 - □ - □ - 01 - □ □ □ - X532
- ZSE20A(F)/ISE20A - □ - □ - 01 - □ □ □ - X532
- ZSE20B(F)/ISE20B - □ - □ - 01 - □ □ □ - X532

Enter the standard product number. (pp. 9, 11, 13)

**• Piping specification**

Symbol	Description
01	R1/8
N01	NPT1/8

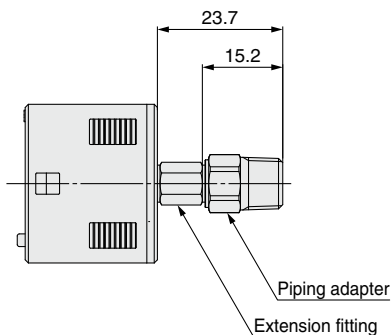

ZSE20(F)  
ISE20

ZSE20A(F)  
ISE20A

ZSE20B(F)  
ISE20B

ZSE20B(F)-L  
ISE20B-L

ZSE20C(F)  
ISE20C(H)

ZSE20C(F)-L  
ISE20C(H)-L

Function  
Details

Made to  
Order

# ZSE20□(F)/ISE20□ Series

Please contact SMC for detailed dimensions, specifications, and delivery times.

**10** □36 mm Panel Hole (Compatible with the panel holes of the Z/ISE40A and Z/ISE80) 20B 20C

This specification includes a panel mount adapter for the mounting holes of the panel mount used by the Z/ISE40A and Z/ISE80.

Symbol	Description
<b>B</b>	Panel mount adapter
<b>D</b>	Panel mount adapter + Front protection cover

Option 2 ●

ZSE20B(F)/ISE20B - □ - □ - □ - □ **B** □ - X521

ZSE20C(F)/ISE20C - □ - □ - □ - □ **B** □ - X521

Enter the standard product number. (pp. 13, 25) ●

## Compatible with the panel holes of the Z/ISE40A

**B**  
Panel mount adapter  
(Part no.: ZS-46-F)

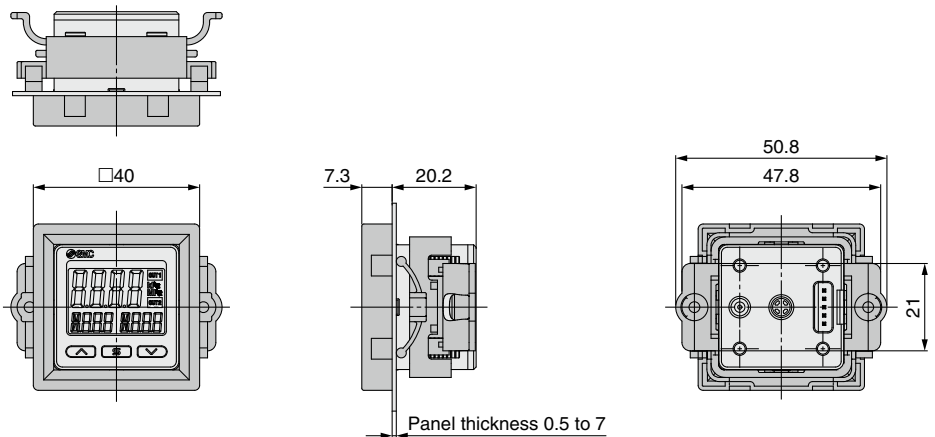

**D**  
Panel mount adapter +  
Front protection cover  
(Part no.: ZS-46-G)

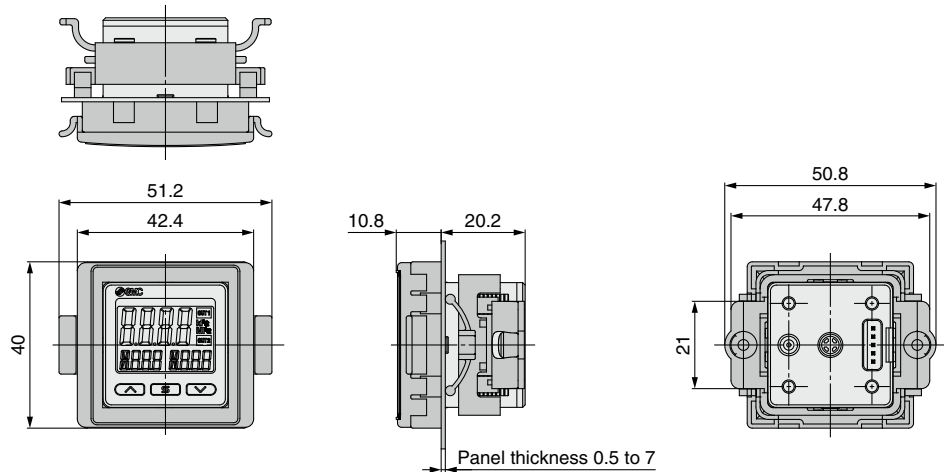

## Panel fitting dimensions

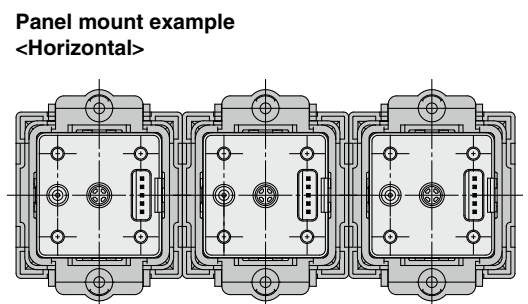
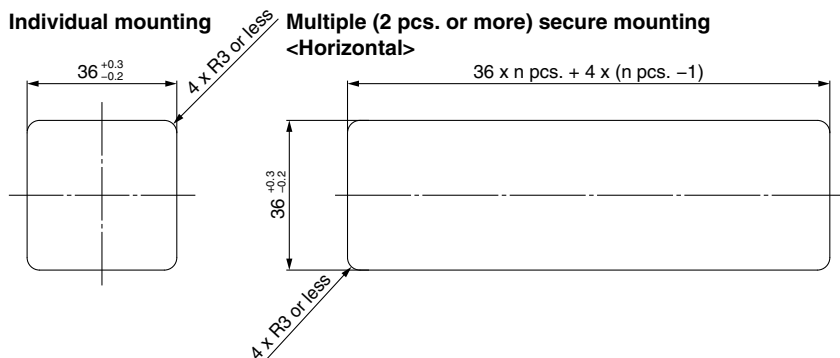



Please contact SMC for detailed dimensions, specifications, and delivery times.

**10** □36 mm Panel Hole (Compatible with the panel holes of the Z/ISE40A and Z/ISE80)

**20B**

**20C**

Compatible with the panel holes of the Z/ISE80

**B**

Panel mount adapter  
(Rear ported)  
(Part no.: ZS-46-F)

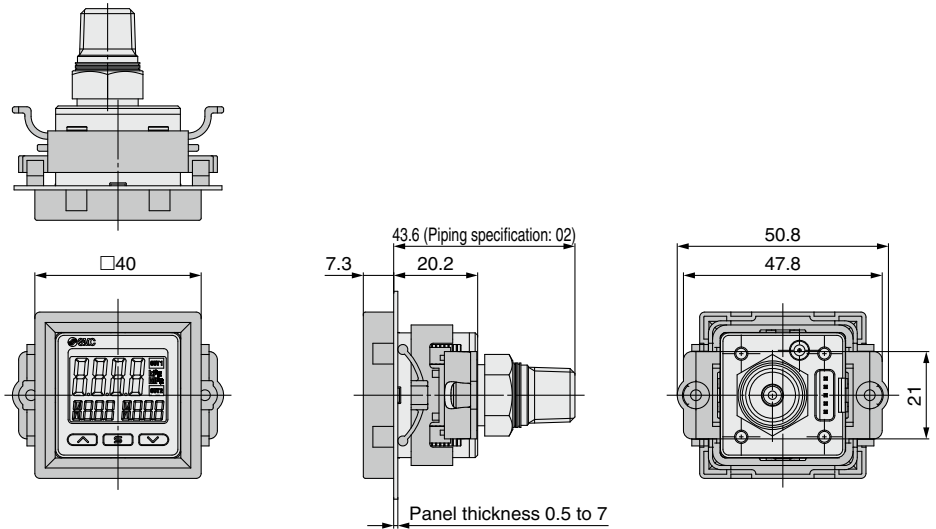

**D**

Panel mount adapter +  
Front protection cover  
(Rear ported)  
(Part no.: ZS-46-G)

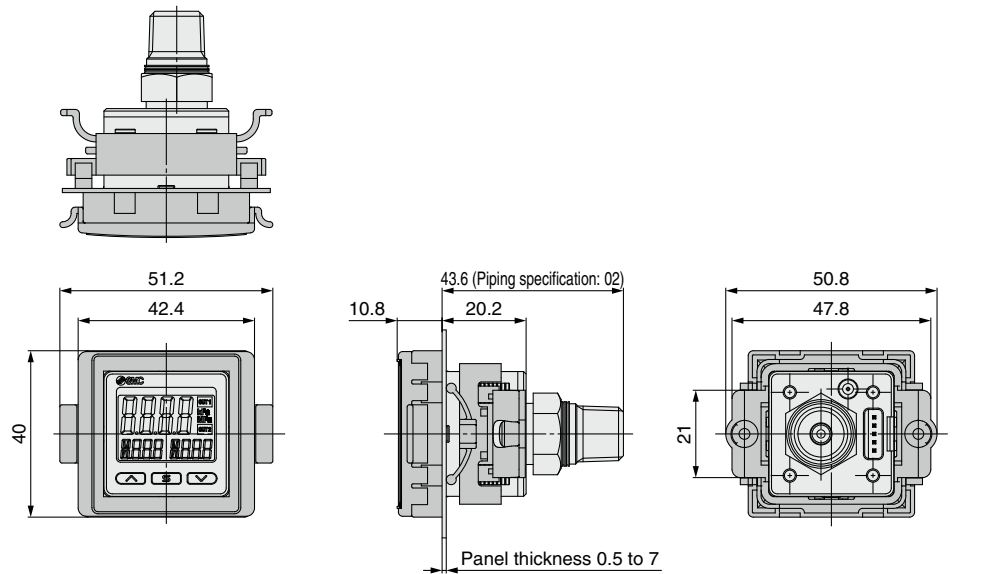

**Panel fitting dimensions (Rear ported)**

Individual mounting

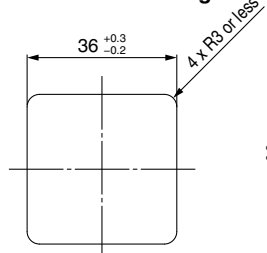

Multiple (2 pcs. or more) secure mounting  
<Horizontal>

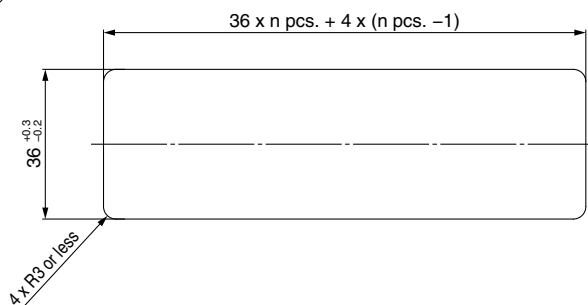

Panel mount example  
<Horizontal>

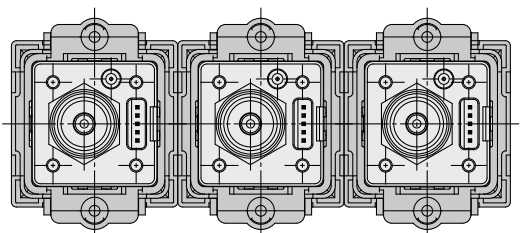

ZSE20(F)  
ISE20

ZSE20A(F)  
ISE20A

ZSE20B(F)  
ISE20B

ZSE20B(F)-L  
ISE20B-L

ZSE20C(F)  
ISE20C(H)

ZSE20C(F)-L  
ISE20C(H)-L

Function  
Details

Made to  
Order

# ZSE20□(F)/ISE20□ Series

Please contact SMC for detailed dimensions, specifications, and delivery times.

## 11 Pressure Switch (for Low Pressure)

20A

Able to detect and display pressures of 10 kPa or less

### How to Order

ZSE20AF - **A** - **M** - **M5** - □ - □ - □ - **X576**

①
②
③
④
⑤
⑥
⑦

#### ① Output specification

Symbol	Description
<b>A</b>	NPN open collector 2 outputs + Copy function
<b>B</b>	PNP open collector 2 outputs + Copy function
<b>C</b>	NPN open collector 1 output + Analog voltage output + External zero-clear*1
<b>D</b>	NPN open collector 1 output + Analog current output + External zero-clear*1

\*1 Can be switched to copy function

#### ② Unit specification

Symbol	Description
<b>Nil</b>	Units selection function*1
<b>M</b>	SI units only*2

\*1 Under the New Measurement Act, switches with the units selection function are no longer allowed for use in Japan.

\*2 Fixed units: kPa, Pa

#### ③ Piping specification

Symbol	Description
<b>M5</b>	M5 female thread

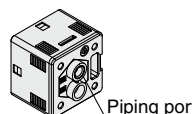

#### ④ Option 1

Symbol	Description
<b>Nil</b>	Without lead wire
<b>J</b>	Lead wire with connector (5-core, 2 m lead wire)

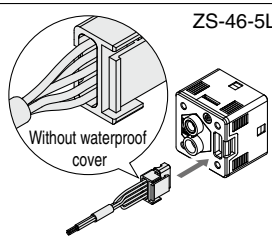

\* For the lead wire with M12 connector, refer to page 43.

#### ⑤ Option 2

Symbol	Description
<b>Nil</b>	None
<b>A1</b>	Bracket A (Vertical mounting)
<b>A2</b>	Bracket B (Horizontal mounting)
<b>B</b>	Panel mount adapter
<b>D</b>	Panel mount adapter + Front protection cover

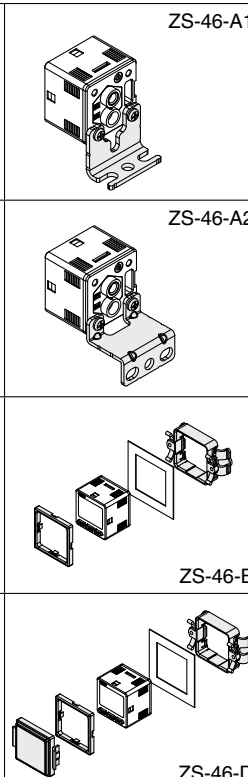

#### ⑥ Option 3

Symbol	Calibration certificate
<b>Nil</b>	—
<b>K</b>	○

#### ⑦ Rated pressure range

Symbol	Description
<b>X576</b>	-500 to 500 Pa
<b>X577</b>	-1.000 to 1.000 kPa
<b>X578</b>	-2.00 to 2.00 kPa
<b>X579</b>	-5.00 to 5.00 kPa
<b>X580</b>	-10.00 to 10.00 kPa

### Options/Part Nos.

When only optional parts are required, order with the part numbers listed below

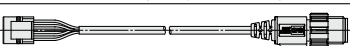
Description	Part no.	Note
Bracket A	<b>ZS-46-A1</b>	Tapping screw: Nominal size 3 x 8 L (2 pcs.)
Bracket B	<b>ZS-46-A2</b>	Tapping screw: Nominal size 3 x 8 L (2 pcs.)
Panel mount adapter	<b>ZS-46-B</b>	—
Panel mount adapter + Front protection cover	<b>ZS-46-D</b>	—
Lead wire with connector	<b>ZS-46-5L</b>	5-core, 2 m, Non-waterproof (Without waterproof cover)
Lead wire with M12 connector	<b>ZS-46-5LM12</b>	 Made to order (Refer to page 43.)
Front protection cover	<b>ZS-27-01</b>	—

Please contact SMC for detailed dimensions, specifications, and delivery times.

**11 Pressure Switch (for Low Pressure)**

**20A**

**Specifications**

Model		X576	X577	X578	X579	X580
<b>Applicable fluid</b>		Air, Non-corrosive gas, Non-flammable gas				
<b>Pressure</b>	<b>Rated pressure range</b>	-500 to 500 Pa	-1.000 to 1.000 kPa	-2.00 to 2.00 kPa	-5.00 to 5.00 kPa	-10.00 to 10.00 kPa
	<b>Display/Set pressure range</b>	-525 to 525 Pa	-1.050 to 1.050 kPa	-2.10 to 2.10 kPa	-5.25 to 5.25 kPa	-10.50 to 10.50 kPa
	<b>Display/Smallest settable increment</b>	1 Pa	0.001 kPa	0.01 kPa	0.01 kPa	0.01 kPa
	<b>Withstand pressure</b>	2.5 kPa	5 kPa	10 kPa	25 kPa	50 kPa
<b>Accuracy</b>	<b>Display accuracy</b>	±2% F.S. ±1 digit (Ambient temperature of 25°C ±3°C)				
	<b>Repeatability</b>	±1% F.S. ±1 digit				
	<b>Temperature characteristics</b>	±3% F.S. (25°C standard)				
<b>Switch output</b>	<b>Output type</b>	NPN open collector output, PNP open collector output				
	<b>Max. load current</b>	80 mA				
	<b>Max. applied voltage (NPN only)</b>	28 V				
	<b>Internal voltage drop (Residual voltage)</b>	1.0 V or less (at load current of 80 mA)				
	<b>Delay time*1</b>	4 ms or less, variable from 0 to 60 s/0.01 s increments				
<b>Analog output</b>	*2 <b>Voltage output</b> <b>Output voltage (Rated pressure range)</b>	Voltage output: 1 to 5 V ±2.5% F.S.				
		<b>Linearity</b>	±1.5% F.S.		±1.0% F.S.	
		<b>Output impedance</b>	Approx. 1 kΩ			
	*3 <b>Current output</b> <b>Output current (Rated pressure range)</b>	Current output: 4 to 20 mA ±2.5% F.S.				
		<b>Linearity</b>	±1.5% F.S.		±1.0% F.S.	
		<b>Load impedance</b>	Max. load impedance		at power supply voltage of 12 V: 300 Ω	
			Min. load impedance		at power supply voltage of 24 V: 600 Ω	
				: 50 Ω		
<b>Analog response time</b>		20 ms				
<b>External zero-clear</b>	<b>Input type</b>	Non-voltage input: 0.4 V or less, Current consumption: 5.5 mA or less				
	<b>Input time</b>	30 ms or more				
<b>Display</b>	<b>Unit*4</b>	kPa, Pa, mbar, psi, inchHg, mmHg, inchH <sub>2</sub> O, mmH <sub>2</sub> O			kPa, mbar, psi, inchHg, mmHg, inchH <sub>2</sub> O, mmH <sub>2</sub> O	
	<b>Display type</b>	LCD				
	<b>Number of screens</b>	3-screen display (Main screen, Sub screen x 2)				
	<b>Display color</b>	1) Main screen: Red/Green 2) Sub screen: Orange				
	<b>Number of display digits</b>	1) Main screen: 4 digits (7 segments) 2) Sub screen: 4 digits (Upper 1 digit 11 segments, 7 segments for other)				
	<b>Indicator light</b>	Lights up when switch output is turned ON. OUT1, OUT2: Orange				
<b>Digital filter*5, *6</b>	Variable from 0 to 30 s/0.01 s increments					
<b>Environmental resistance</b>	<b>Operating temperature range</b>	Operating: -5 to 50°C, Stored: -10 to 60°C (No condensation)				
	<b>Operating humidity range</b>	Operating/Stored: 35 to 85% RH (No condensation)				
<b>Standards</b>		UL/CSA (E216656), CE/UKCA marking				

- \*1 Value without digital filter (at 0 ms)
- \*2 Analog voltage output and analog current output cannot be selected at the same time.
- \*3 Analog current output and analog voltage output cannot be selected at the same time.
- \*4 Setting is only possible for models with the units selection function.  
Only kPa or Pa is available for models without this function.
- \*5 The response time indicates when the set value is 90% in relation to the step input.
- \*6 Display, switch output, and analog response time are affected.
- \* Products with tiny scratches, marks, or display color or brightness variations which do not affect the performance of the product are verified as conforming products.

For specifications other than those shown above, refer to page 12.

**Dimensions**

**ZSE20AF - □ - □ - M5 - □ □ □ - X576 to X580**

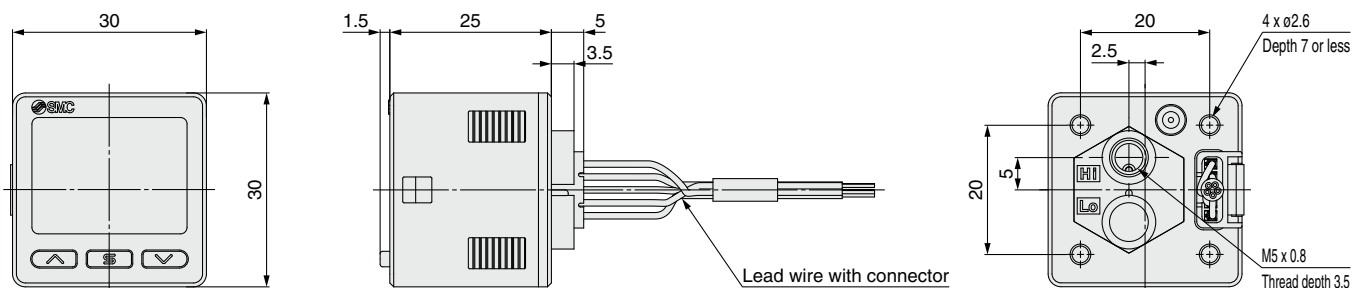

ZSE20(F)  
ISE20

ZSE20A(F)  
ISE20A

ZSE20B(F)  
ISE20B

ZSE20B(F)-L  
ISE20B-L

ZSE20C(F)  
ISE20C(H)

ZSE20C(F)-L  
ISE20C(H)-L

Function  
Details

Made to  
Order

# ZSE20□(F)/ISE20□ Series

Please contact SMC for detailed dimensions, specifications, and delivery times.

## 12 Integrated R1/8 Fitting with Bottom Wiring Entry

20

20A

20B

This is a product with an R1/8 fitting integrated into the product body, with the lead wire with connector entry on the bottom of the product.

The lead wire with connector entry being located on the bottom of the product has the following merits.

- No need for space at the back of the product for wiring connection and handling
- Allows for the avoidance of interference with peripheral components (when the connector entry is at the back of the product)
- Piping port: R1/8 (With M5 female thread)
- Insert nuts can be used for the tightening part of the bracket mounting screws.
- A lead wire with molded connector cover (waterproof type) can be used.

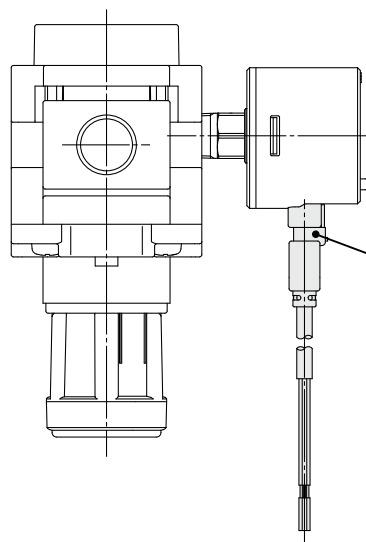

Lead wire with connector connection part  
\* Improved wiring handling



### Non-waterproof type

ZSE20(F) / ISE20 - □ - □ - 01 - □ □ □ - X610

ZSE20A(F) / ISE20A - □ - □ - 01 - □ □ □ - X610

Enter the standard product number. (pp. 9, 11) •

\* It is not selectable for the panel mount type. For option 2 selection, refer to the compatibility table below.

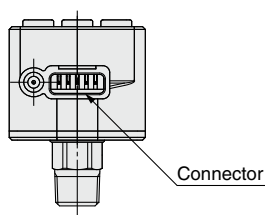
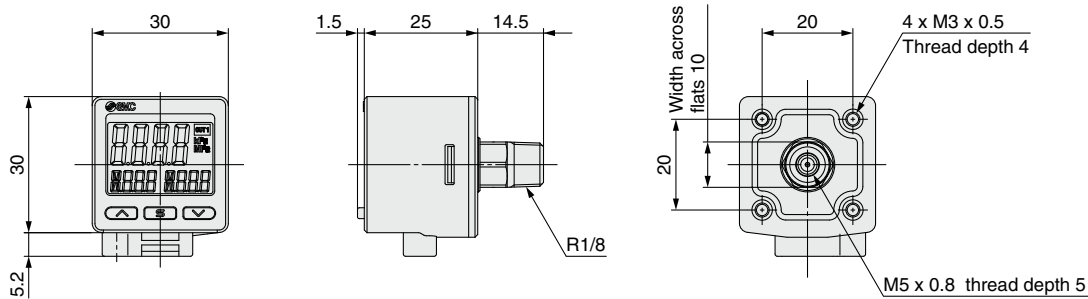

Symbol	Description	Part no.	Compatibility
			X610
Nil	None		○
A1	Bracket A	ZS-24-A	○
A2	Bracket B	ZS-46-A2	×
B	Panel mount adapter	ZS-46-B	×
D	Panel mount adapter + Front protection cover	ZS-46-D	×

Please contact SMC for detailed dimensions, specifications, and delivery times.

**12** Integrated R1/8 Fitting with Bottom Wiring Entry

20

20A

20B

**Waterproof type**

ZSE20B(F)/ISE20B - □ - □ - 01 - W □ □ - X615

Enter the standard product number. (p. 13)

\* It is not selectable for the panel mount type. For option 2 selection, refer to the compatibility table below.

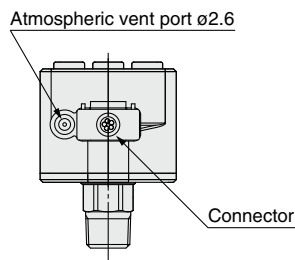
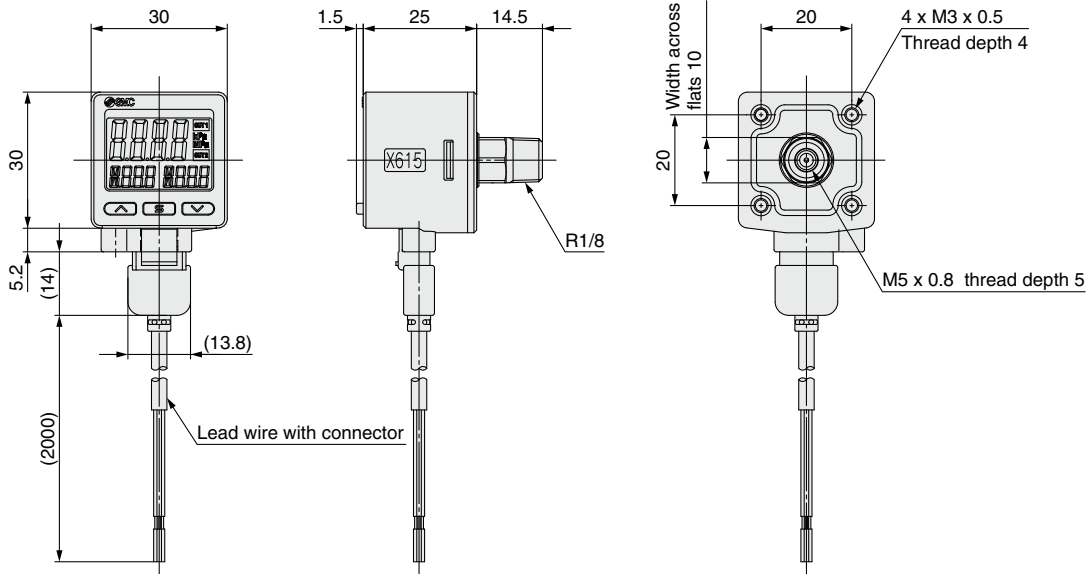

Symbol	Description	Part no.	Compatibility	
			X615	
Nil	None		○	
A1	Bracket A	ZS-24-A	○	
A2	Bracket B	ZS-46-A2	×	
B	Panel mount adapter	ZS-46-B	×	
D	Panel mount adapter + Front protection cover	ZS-46-D	×	

**Accessory (for the X615): Lead wire with molded connector cover**

**Straight type ZS-46-5F-X525**

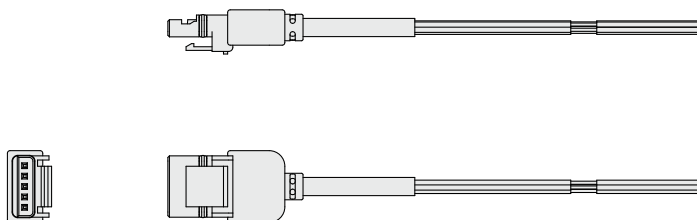

ZSE20(F)  
ISE20

ZSE20A(F)  
ISE20A

ZSE20B(F)  
ISE20B

ZSE20B(F)-L  
ISE20B-L

ZSE20C(F)  
ISE20C(H)

ZSE20C(F)-L  
ISE20C(H)-L

Function  
Details

Made to  
Order

## Safety Instructions

These safety instructions are intended to prevent hazardous situations and/or equipment damage. These instructions indicate the level of potential hazard with the labels of “**Caution**,” “**Warning**” or “**Danger**.” They are all important notes for safety and must be followed in addition to International Standards (ISO/IEC)\*1), and other safety regulations.

 **Caution:** **Caution** indicates a hazard with a low level of risk which, if not avoided, could result in minor or moderate injury.

 **Warning:** **Warning** indicates a hazard with a medium level of risk which, if not avoided, could result in death or serious injury.

 **Danger:** **Danger** indicates a hazard with a high level of risk which, if not avoided, will result in death or serious injury.

\*1) ISO 4414: Pneumatic fluid power – General rules relating to systems.  
ISO 4413: Hydraulic fluid power – General rules relating to systems.  
IEC 60204-1: Safety of machinery – Electrical equipment of machines.  
(Part 1: General requirements)  
ISO 10218-1: Manipulating industrial robots – Safety.  
etc.

### Warning

#### 1. The compatibility of the product is the responsibility of the person who designs the equipment or decides its specifications.

Since the product specified here is used under various operating conditions, its compatibility with specific equipment must be decided by the person who designs the equipment or decides its specifications based on necessary analysis and test results. The expected performance and safety assurance of the equipment will be the responsibility of the person who has determined its compatibility with the product. This person should also continuously review all specifications of the product referring to its latest catalog information, with a view to giving due consideration to any possibility of equipment failure when configuring the equipment.

#### 2. Only personnel with appropriate training should operate machinery and equipment.

The product specified here may become unsafe if handled incorrectly. The assembly, operation and maintenance of machines or equipment including our products must be performed by an operator who is appropriately trained and experienced.

#### 3. Do not service or attempt to remove product and machinery/equipment until safety is confirmed.

1. The inspection and maintenance of machinery/equipment should only be performed after measures to prevent falling or runaway of the driven objects have been confirmed.
2. When the product is to be removed, confirm that the safety measures as mentioned above are implemented and the power from any appropriate source is cut, and read and understand the specific product precautions of all relevant products carefully.
3. Before machinery/equipment is restarted, take measures to prevent unexpected operation and malfunction.

#### 4. Contact SMC beforehand and take special consideration of safety measures if the product is to be used in any of the following conditions.

1. Conditions and environments outside of the given specifications, or use outdoors or in a place exposed to direct sunlight.
2. Installation on equipment in conjunction with atomic energy, railways, air navigation, space, shipping, vehicles, military, medical treatment, combustion and recreation, or equipment in contact with food and beverages, emergency stop circuits, clutch and brake circuits in press applications, safety equipment or other applications unsuitable for the standard specifications described in the product catalog.
3. An application which could have negative effects on people, property, or animals requiring special safety analysis.
4. Use in an interlock circuit, which requires the provision of double interlock for possible failure by using a mechanical protective function, and periodical checks to confirm proper operation.

### Caution

#### 1. The product is provided for use in manufacturing industries.

The product herein described is basically provided for peaceful use in manufacturing industries.  
If considering using the product in other industries, consult SMC beforehand and exchange specifications or a contract if necessary.  
If anything is unclear, contact your nearest sales branch.

### Limited warranty and Disclaimer/ Compliance Requirements

The product used is subject to the following “Limited warranty and Disclaimer” and “Compliance Requirements”.

Read and accept them before using the product.

#### Limited warranty and Disclaimer

1. The warranty period of the product is 1 year in service or 1.5 years after the product is delivered, whichever is first.\*2)  
Also, the product may have specified durability, running distance or replacement parts. Please consult your nearest sales branch.
2. For any failure or damage reported within the warranty period which is clearly our responsibility, a replacement product or necessary parts will be provided.  
This limited warranty applies only to our product independently, and not to any other damage incurred due to the failure of the product.
3. Prior to using SMC products, please read and understand the warranty terms and disclaimers noted in the specified catalog for the particular products.

\*2) Vacuum pads are excluded from this 1 year warranty.

A vacuum pad is a consumable part, so it is warranted for a year after it is delivered.  
Also, even within the warranty period, the wear of a product due to the use of the vacuum pad or failure due to the deterioration of rubber material are not covered by the limited warranty.

#### Compliance Requirements

1. The use of SMC products with production equipment for the manufacture of weapons of mass destruction (WMD) or any other weapon is strictly prohibited.
2. The exports of SMC products or technology from one country to another are governed by the relevant security laws and regulations of the countries involved in the transaction. Prior to the shipment of a SMC product to another country, assure that all local rules governing that export are known and followed.

### Caution

#### SMC products are not intended for use as instruments for legal metrology.

Measurement instruments that SMC manufactures or sells have not been qualified by type approval tests relevant to the metrology (measurement) laws of each country. Therefore, SMC products cannot be used for business or certification ordained by the metrology (measurement) laws of each country.

#### Revision History

**Edition B** \* New variations (for general fluids, IP65, 2 outputs, and analog output) have been added.

\* The number of pages has been increased from 16 to 36. VX

**Edition C** \* An IO-Link compatible type has been added. (Z/ISE20B series)

\* The number of pages has been increased from 36 to 40. WR

**Edition D** \* Made to order options have been added.

\* A One-touch fitting type has been added to the piping specifications.

\* The number of pages has been increased from 40 to 44. YY

**Edition E** \* An IO-Link compatible type has been added. (Z/ISE20C series)

\* A low pressure range type has been added. (Z/ISE20A series)

\* An M12 connector compatible type has been added. (Made to Order)

\* The number of pages has been increased from 44 to 52.

## Safety Instructions

Be sure to read the “Handling Precautions for SMC Products” (M-E03-3) and “Operation Manual” before use.

## SMC Corporation

Akihabara UDX 15F,  
4-14-1, Sotokanda, Chiyoda-ku, Tokyo 101-0021, JAPAN  
Phone: 03-5207-8249 Fax: 03-5298-5362  
<https://www.smcworld.com>  
© 2023 SMC Corporation All Rights Reserved

Specifications are subject to change without prior notice and any obligation on the part of the manufacturer.

D-G