

# Series 10-AS

Speed Controller/In-line Type  
10-AS1000, 2000, 3000, 4000, 5000

RoHS

## How to Order



**Clean series**

**Body size**

1	M3, M5 standard
2	1/8, 1/4 standard
3	3/8 standard
4	1/2 standard
5	1/2 standard

**In-line type**

**10 - AS 1 000 - M5 -**

**Port size**

Port size	Applicable series
M3	M3 x 0.5
M5	M5 x 0.8
01	Rc1/8
02	Rc1/4
03	Rc3/8
04	Rc1/2

**Lock nut option**

Nil	Hexagon lock nut
J	Round lock nut

Note) The round lock nut option is only for AS1000.

## Model/Flow Rate and Sonic Conductance

Model	Port size	Free flow			Controlled flow			Weight (g)
		Flow rate L/min (ANR)	Sonic conductance dm <sup>3</sup> /(s·bar)	Critical pressure ratio	Flow rate L/min (ANR)	Sonic conductance dm <sup>3</sup> /(s·bar)	Critical pressure ratio	
10-AS1000-M3	M3 x 0.5	20	0.06	0.15	20	0.06	0.2	4.7
10-AS1000-M5	M5 x 0.8	90	0.25		80	0.22		33
10-AS2000-01	1/8	340	0.94		250	0.7		90
10-AS2000-02	1/4	340	0.94		250	0.7		115
10-AS3000-02	1/4	810	2.3	0.35	810	2.3	0.2	130
10-AS3000-03	3/8	810	2.3		810	2.3		124
10-AS4000-02	1/4	1,670	4.6		1,670	4.6		221
10-AS4000-03	3/8	1,670	4.6		1,670	4.6		214
10-AS4000-04	1/2	1,670	4.6		1,670	4.6		205
10-AS5000-02	1/4	2,840	7.9		2,840	7.9		242
10-AS5000-03	3/8	4,270	11.9	4,270	11.9	233		
10-AS5000-04	1/2	4,270	11.9				4,270	11.9

Note) Supply pressure: 0.5 MPa, Temperature: 20°C.

## Specifications

<b>Proof pressure</b> <sup>Note)</sup>	1.5 MPa (1.05 MPa)
<b>Operating pressure range</b> <sup>Note)</sup>	0.05 to 1.0 MPa (0.1 to 0.7 MPa)
<b>Ambient and fluid temperature</b>	-5 to 60°C (No freezing)
<b>Grease</b>	Fluorine grease
<b>Cleanliness class (ISO class)</b>	Class 3

Note) Descriptions in parentheses are for 10-AS1000.

**Needle Valve / Flow Rate Characteristics**

**10-AS1000-M3**

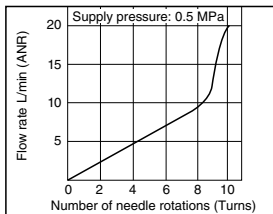

**10-AS1000-M5**

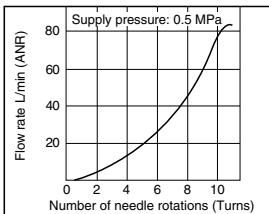

**10-AS2000**

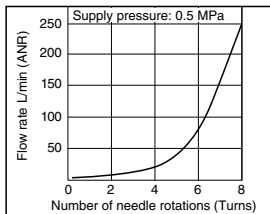

**10-AS3000**

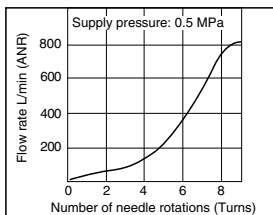

**10-AS4000**

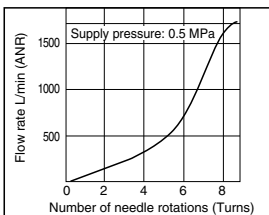

**10-AS5000**

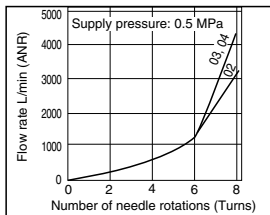

**Dimensions**

**10-AS1000-M3**

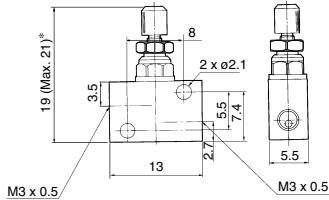

\* Reference dimensions

**10-AS1000-M5**

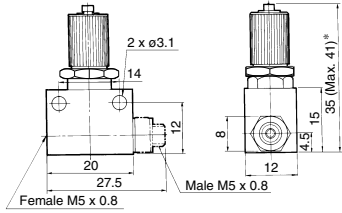

\* Reference dimensions

**10-AS2000/3000**

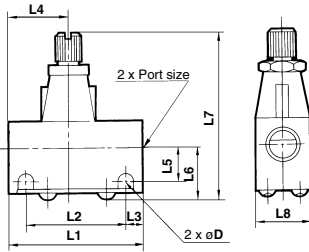

**10-AS4000**

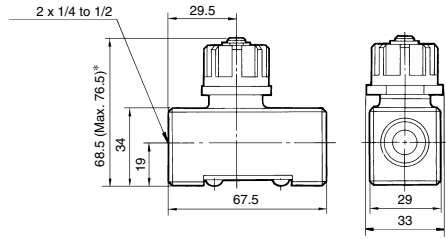

**Dimensions**

Model	Port size	L1	L2	L3	L4	L5	L6	L7 MAX. MIN.	L8	D
10-AS2000-01	1/8	40	30	5	17	10	15.5	54.5 50	16	4.5
10-AS2000-02	1/4				23	11.5	17	56 51.5	20	
10-AS3000-02/03	1/4, 3/8	56	45.5	5.25	25	13.2	20.6	68 61	26	5.5

**10-AS5000**

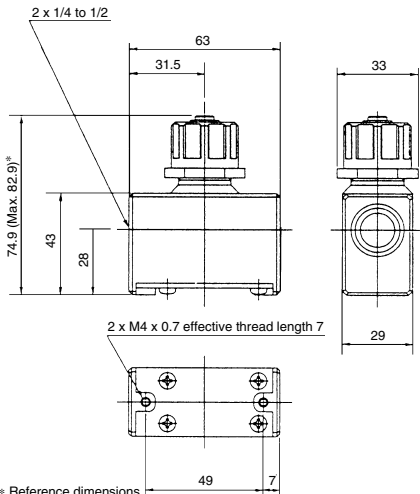

\* Reference dimensions

\* Reference dimensions

2 x M4 x 0.7  
Effective thread length 6

Directional Control Valves

Air Cylinders

Rotary Actuators

Air Grippers

Air Preparation Equipment

Modular F. R.

Pressure Control Equipment

Fittings & Tubing

Flow Control Equipment

Pressure Switches/ Pressure Sensors